

ZP SERIES POSITIVE DISPLACEMENT PUMPS



ZP Series Pumps

REDEFINING ENGINEERED EXCELLENCE

The ZP Series establishes a new standard of value, quality and features in the positive displacement pump market.

In 2010, Ampco introduced the ZP1 and ZP2 Series of positive displacement pumps. The ZP Series offers more standard features than competing pumps including a stainless steel gearcase. ZP1 and ZP2 Series pumps are part-for-part, 100% interchangeable with the competition.

Raising the bar in 2012 Ampco introduced the ZP3 Series. The patented ZP3 is fully CIP-able without modification or loss of efficiency. The front-loading seal design allows for fast and easy maintenance without removing process piping or the heavy fluid end. The unique rotor case design eliminates all dead zones within the pump making the ZP3 the only fully CIP-able choice in sanitary positive displacement pumps. The ZP3 is EHEDG certified; in conformance with 3A standards and the ATEX Directive.

Further advancing the traditional design features of positive displacement pumps Ampco introduced the patented ZP1+ Series, which is designed to allow o-ring seals to be changed without disconnecting the pump from the piping system. Both the ZP3 and ZP1+ set a new standard for sanitary processing. The entire ZP Series offers quality, enhanced features, value and proven performance.



Available Options

- Rectangular inlets
- Heating jackets
- Pressure relief valves
- Aseptic design
- Optional rotor designs
- Full assemblies
- Flat body profile
- Tethered wing nuts
- Cover handles
- Consult with engineering for additional options

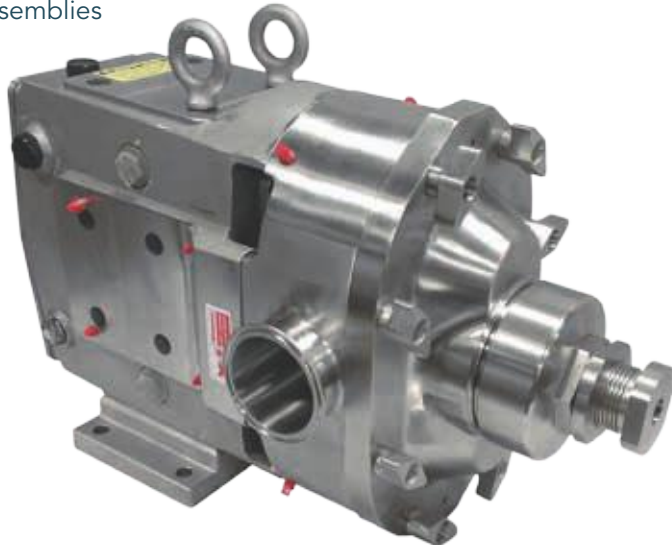

ZP GENERAL PERFORMANCE RANGE

- Capacity range: 0.1 to 648 gpm (0.02 to 147.2 m³/hr)
- Pressure range: up to 500 psi/34 Bar
- Temperature range: -40°F to +300°F (-40°C to +150°C)
Note: Hot clearances required for high temp operation
- Viscosity range: 1 to 1,000,000 CPS



Ampco Pumps Company is ISO 9001:2008 certified.

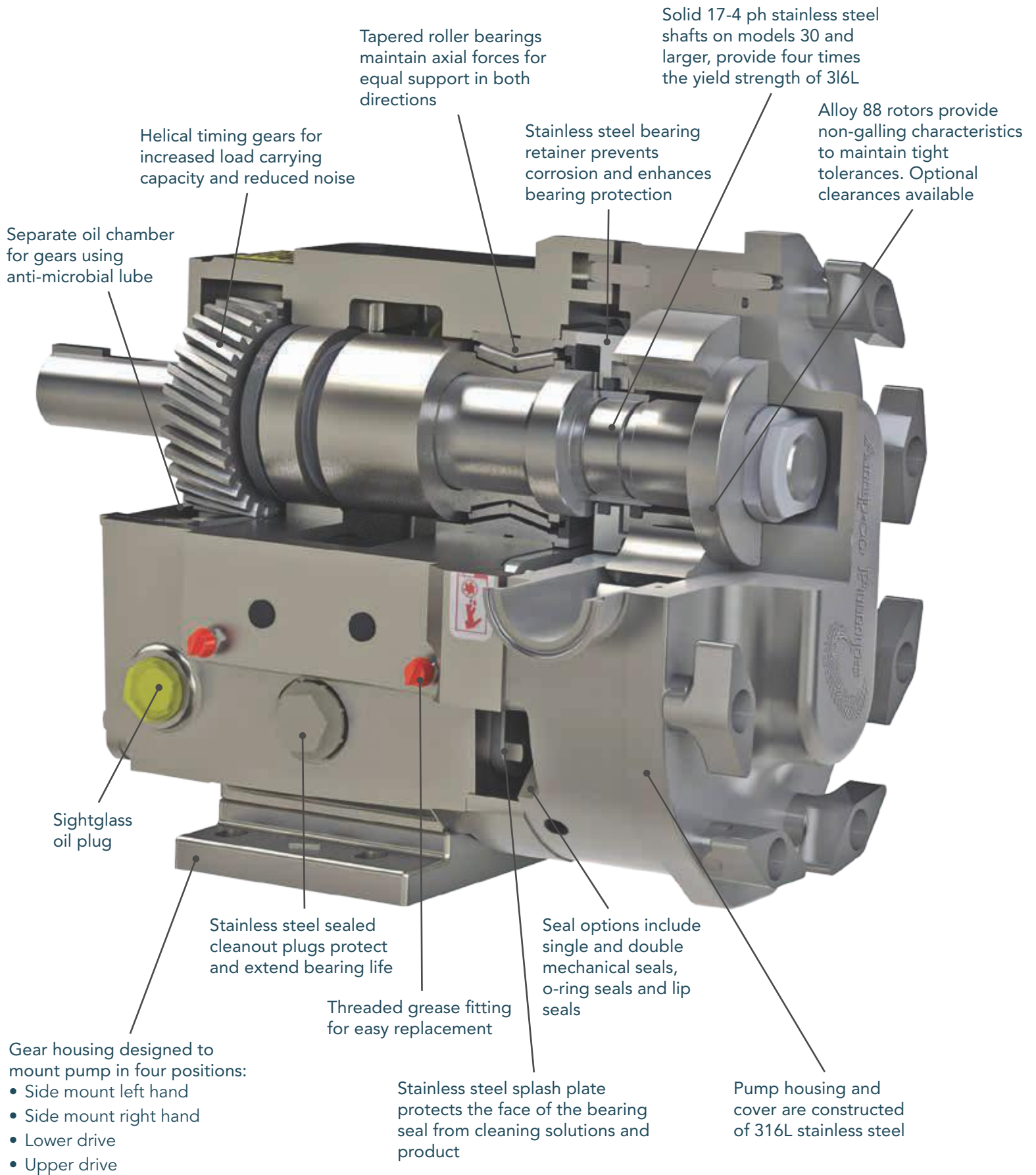

ALL ZP PUMPS INCLUDE

a stainless steel gearcase, providing high-resistance to corrosion and compatibility with caustic agents.

ALL ZP PUMPS INCLUDE

stainless steel cleanout plugs and splash plate.

ALL STAINLESS STEEL

hardware prevents corrosion and stripped bolts.

ZP3 SERIES

THE SIMPLE CHOICE FOR SANITARY PROCESSING

Ampco's patented ZP3 Series is CIP-able without modification or loss of efficiency. The front-loading seal design reduces maintenance time and costs.

ZP3 SERIES FEATURES

- Front-loading seals are located closer to the product flow, offering improved CIP-ability with no disassembly required.
- Front-loading seals allow for ease-of-maintenance and reduced service time. Maintenance personnel no longer need to disconnect the pump from piping.
- EHEDG Certified and in conformance with 3A Sanitary Standards and the ATEX Directive.
- Cover design maximizes exposure of the cover o-ring to the CIP fluid.
- Free drain design improves CIP-ability while maintaining maximum pump efficiency.
- CIP holes in rotor ensure turbulent flow to the cover hub.
- Elimination of dead zones in shaft bore improves cleanability and increases seal life.
- The ZP3 pump is mounted on a ZP2 gear case, including shafts, to maximize parts interchangeability.
- Existing ZP2 pumps (and our competitors' similar pumps) can be upgraded to the ZP3 design with new rotors, seals and re-machining the existing rotor case.
- New pumps can be reconditioned 2 to 3 times.



For additional information on the ZP3 Series and other Ampco products, please visit www.ampcopumps.com.



ZP3 PERFORMANCE

SAMPLE COMPARISON CHART

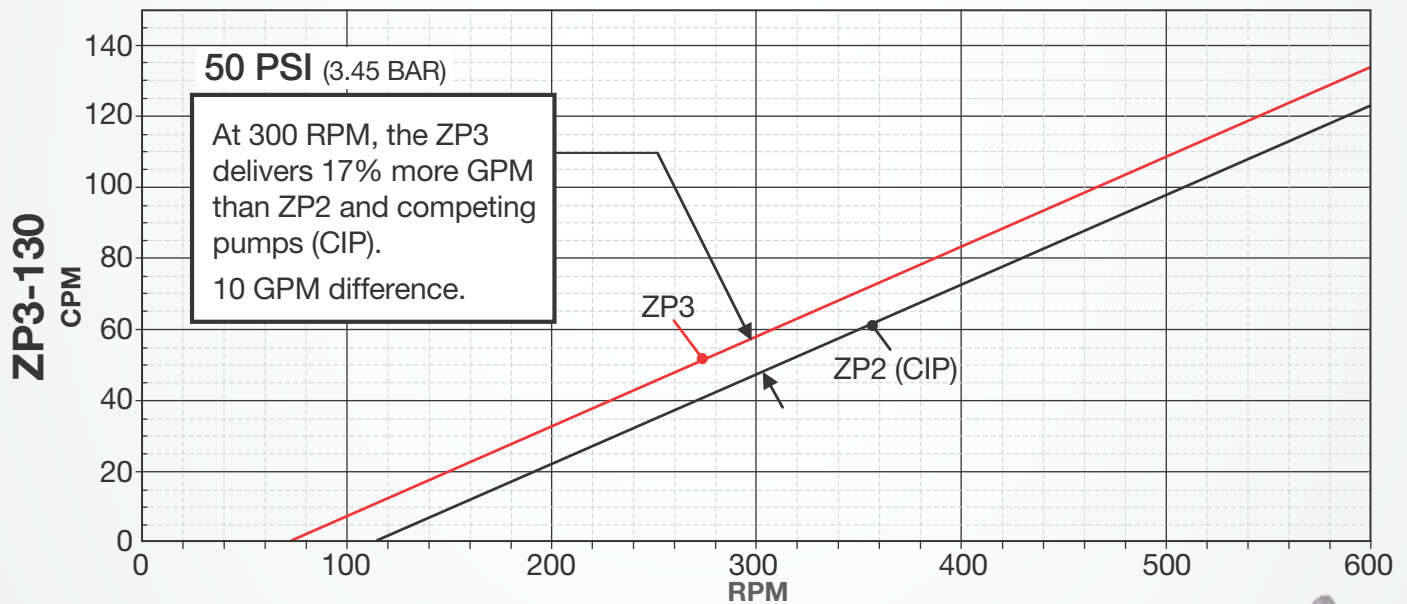
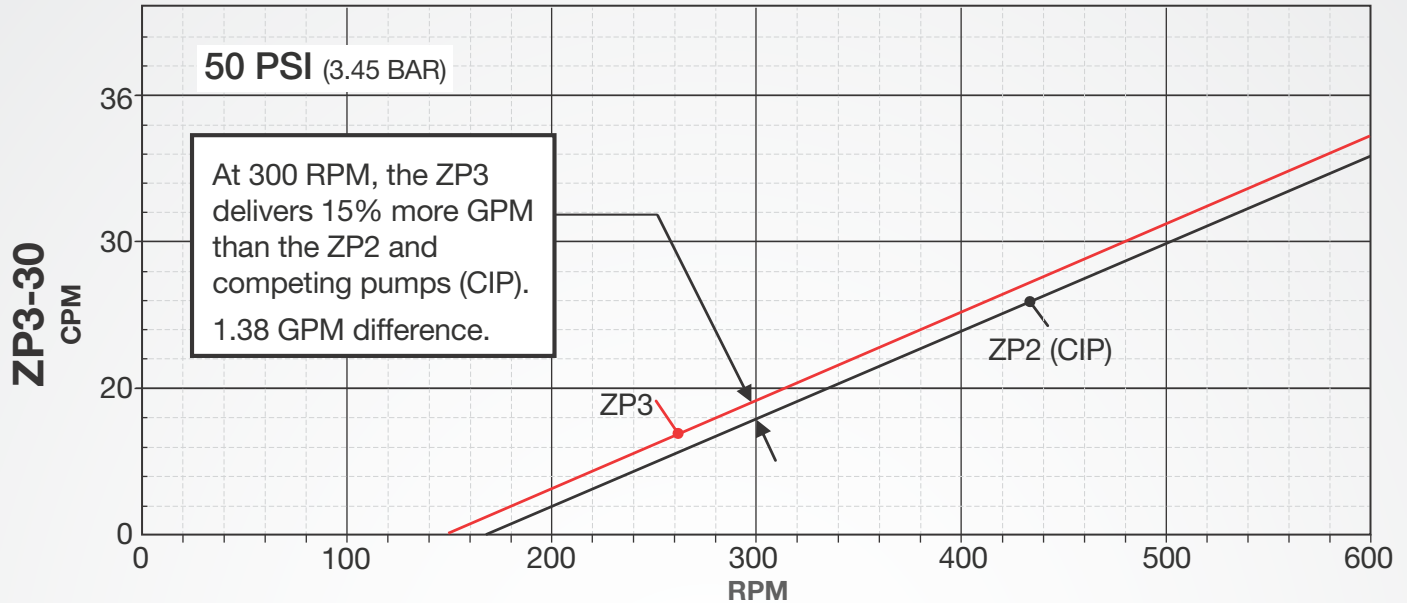

AMPCO ZP SERIES ADVANTAGES

Only Ampco ZP pumps offer all of these upgrades at no additional charge

- Stainless steel gearcase
- Stainless steel retainers
- 17-4ph shafts
- Helical gears
- 4-way mounting
- 2-side threaded grease zerks
- Anti-microbial lube
- 6 oil fill plugs with sight glass
- Gasketed stainless steel cleanout plugs and splash plate.



ZP1+ SERIES

Ampco continues to bring innovation to the sanitary pump market. We have enhanced the traditional design of the popular ZP1 pump and are pleased to introduce the ZP1+ (available in models 30 and larger) for ease of maintenance and reduced downtime.

Patented ZP1+ Easy Maintenance and Reduced Downtime



AMPCO ZP1+ DESIGN

The patented design changes the position of the static and dynamic o-ring, allowing replacement without having to disconnect the pump from the piping system, providing easy maintenance and reduced downtime. The secondary sleeve and assembly will seal the pump if the rotors are removed for CIP processing.

REMANUFACTURING OPTION

Existing ZP1 pumps (and competing models) can be converted to a ZP1+ pump during the remanufacturing process at no extra charge.

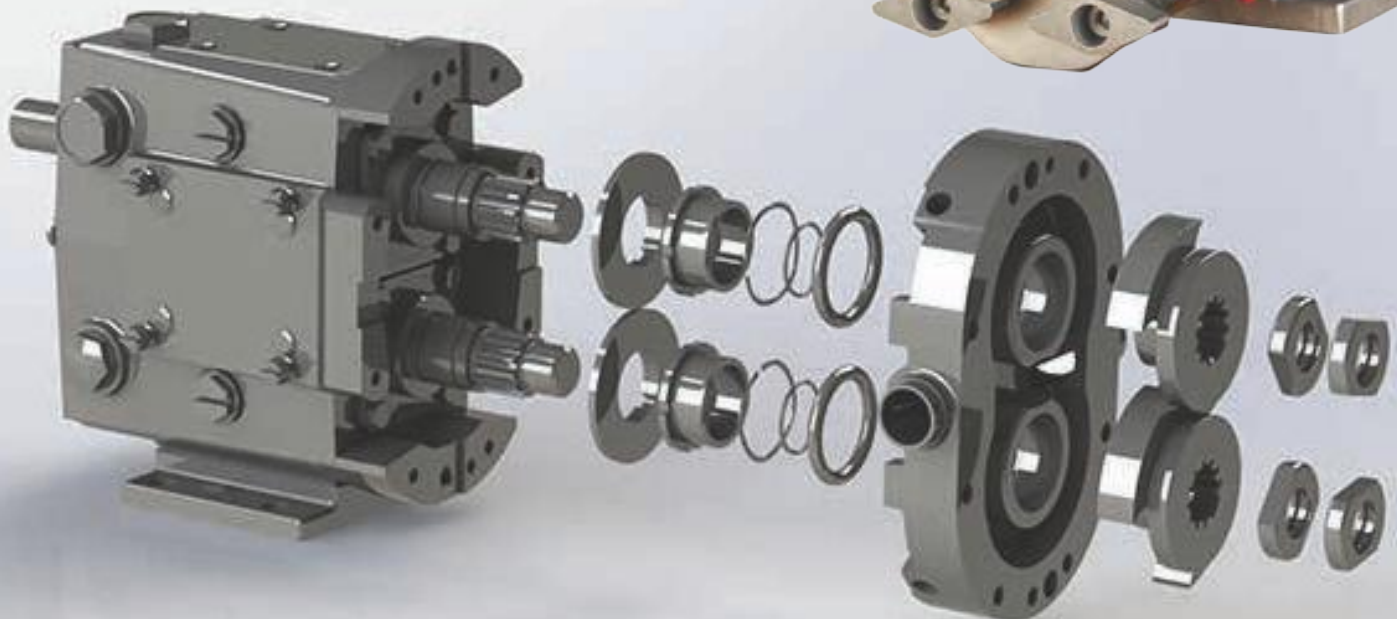

Ampco Pumps Company is
ISO 9001:2008 certified.



2045 W. Mill Road
Glendale, WI 53209
Phone: 800.737.8671
info@ampcopumps.com

Am Gäxwald 6
76863 Herxheim Germany
Phone: +49 7276 5058515
info@ampcopumps.de



www.ampcopumps.com



ZP PUMP TECHNICAL DATA

ZP1 PUMP PERFORMANCE

Model ZP1	Nominal Capacity		Displacement		Maximum Differential Pressure		Standard Connection Size		Optional Connection Size		Maximum Speed Rev/Min	Temperature Range	
	GPM	M ³ /hr	Gal/Rev	L/Rev	PSI	Bar	IN.	MM.	IN.	MM.		°F	°C
6	7	1.6	.0082	.031	200	13.8	1"	25	1½"	38	800	-40° to 300°	-40° to 149°
15	10	2.3	.0142	.054	200	13.8	1½"	38	—	—	700		
18	17	3.9	.029	.110	200	13.8	1½"	38	2"	51	600		
30	36	8.2	.060	.227	200	13.8	1½"	38	2"	51	600		
40	46	10.4	.076	.288	150	10.3	2"	51	2½"	64	600		
60	92	20.9	.153	.579	200	13.8	2½"	64	3"	76	600		
130	152	34.5	.254	.961	200	13.8	3"	76	—	—	600		
220	313	71.1	.522	1.976	200	13.8	4"	102	—	—	600		
320	452	103	.754	2.854	200	13.8	6"	152	—	—	600		
323	370	84	.616	2.332	225	15.5	6"	152	—	—	600		

Model ZP1	Nominal Capacity		Displacement		Maximum Differential Pressure		Rec. Inlet (W x L)		Outlet		Maximum Speed Rev/Min	Temperature Range	
	GPM	M ³ /hr	Gal/Rev	L/Rev	PSI	Bar	IN.	MM.	IN.	MM.		°F	°C
34	24	5.5	.060	.227	200	13.8	1.75 x 6.75	44 x 171	2"	51	400	-40° to 300°	-40° to 149°
64	61	13.9	.153	.579	200	13.8	2.24 x 8.82	57 x 224	2½" (3")	64 (76)	400		
134	102	23.2	.254	.961	200	13.8	2.97 x 9.25	75 x 235	3"	76	400		
224	208	47.2	.521	1.972	200	13.8	3.87 x 11	98 x 279	4"	102	400		
324	301	68.3	0.754	2.854	200	13.8	5.00 x 17.38	127 x 441	6"	152	400		

ZP2 / ZP3 PUMP PERFORMANCE

Model ZP2 ZP3	Nominal Capacity		Displacement		Maximum Differential Pressure		Standard Connection Size		Optional Connection Size		Maximum Speed Rev/Min	Temperature Range	
	GPM	M ³ /hr	Gal/Rev	L/Rev	PSI	Bar	IN.	MM.	IN.	MM.		°F	°C
6	8	1.8	.0082	.031	300	20.7	1"	25	1½"	38	1000	-40° to 300°	-40° to 149°
15	11	2.5	.0142	.054	250	17.2	1½"	38	—	—	800		
18	20	4.5	.029	.110	200	13.8	1½"	38	2"	51	700		
30	36	8.2	.060	.227	250	17.2	1½"	38	2"	51	600		
40	46	10.4	.076	.288	150	10.3	2"	51	2½"	64	600		
45	59	13.4	.098	.371	450	31.0	2"	51	—	—	600		
60	92	20.9	.153	.579	300	20.7	2½"	64	3"	76	600		
130	152	34.5	.254	.961	200	13.8	3"	76	—	—	600		
180	228	51.8	.380	1.438	450	31.0	3"	76	—	—	600		
210	301	68.4	.502	1.900	500	34.5	4"	102	—	—	600		
220	313	71.1	.522	1.976	300	20.7	4"	102	—	—	600		
320	452	103	.754	2.854	300	20.7	6"	152	—	—	600		

Model ZP2 ZP3	Nominal Capacity		Displacement		Maximum Differential Pressure		Rec. Inlet (W x L)		Outlet		Maximum Speed Rev/Min	Temperature Range	
	GPM	M ³ /hr	Gal/Rev	L/Rev	PSI	Bar	IN.	MM.	IN.	MM.		°F	°C
34	24	5.5	.060	.227	250	17.2	1.81 x 6.84	46 x 174	2"	51	400	-40° to 300°	-40° to 149°
64	61	13.9	.153	.579	300	20.7	2.44 x 9.0	62 x 229	2½" (3")	64 (76)	400		
134	102	23.2	.254	.961	200	13.8	3.19 x 9.38	81 x 238	3"	76	400		
184	152	34.5	.380	1.438	450	31.0	3.28 x 11.25	83 x 286	3"	76	400		
214	200	45.4	.502	1.90	500	34.5	3.45 x 12.70	88 x 323	4"	102	400		
224	208	47.2	.521	1.972	300	20.7	4.06 x 11.25	103 x 286	4"	102	400		
324	401	91	.752	2.847	300	20.7	4.25 x 12.7	108 x 322.5	6"	152.4	400		

XP PUMP PERFORMANCE

XP Model	Nominal Capacity		Displacement		Maximum Differential Pressure		STD Connection		Maximum Speed Rev/Min	Temperature Range	
	GPM	M ³ /hr	Gal/Rev	L/Rev	PSI	Bar	IN.	MM.		°F	°C
320	452	103	.754	2.854	200	13.8	6"	152	600	-40° to 300°	-40° to 149°
323	370	84	.616	2.332	225	15.5	6"	152	600		
380	660	150	1.10	4.164	250	17.2	6"	152	600		
420	648	145.4	1.62	6.129	200	13.8	6"	152	400		
423	648	145.4	1.62	6.129	200	13.8	6"	152	400		

Please visit www.ampcopumps.com for individual pump curves and dimensional drawings.

ZP1 PUMP DIMENSIONS

Model ZP1		A	B	C	D	E	F	G	H	I	J
6	IN	4.75	1.95	3.75	12.04	5.50	1.94	2.31	.41, SLOT	2.93	9.61
	MM	.21	50	95	306	140	49	59	10, SLOT	74	244
15	IN	4.75	1.95	3.75	12.04	5.50	1.94	2.31	.41, SLOT	2.93	9.61
	MM	121	50	95	306	140	49	59	10, SLOT	74	244
18	IN	4.75	2.18	3.75	12.46	5.50	1.94	2.31	.41, SLOT	2.93	9.84
	MM	121	55	95	316	140	49	59	10, SLOT	74	250
30	IN	6.25	2.78	4.25	14.58	6.86	2.31	2.56	.41, SLOT	3.56	11.61
	MM	159	71	108	370	174	59	65	10, SLOT	90	295
40	IN	6.25	2.94	4.25	14.96	6.86	2.31	2.56	.41, SLOT	3.56	11.99
	MM	159	75	108	380	174	59	65	10, SLOT	90	305
60	IN	8.25	4.14	5.87	18.91	9.56	3.50	4.12	0.53	5.06	15.14
	MM	210	105	149	480	243	89	105	13	129	385
130	IN	8.25	4.78	5.87	19.85	9.56	3.50	4.12	0.53	5.06	15.77
	MM	210	121	149	504	243	89	105	13	129	401
220	IN	8.50	3.69	9.00	23.37	12.38	3.75	7.25	.53, SLOT	6.88	18.49
	MM	216	94	229	594	314	95	184	13 SLOT	162	470
320	IN	12.00	4.12	11.63	30.17	13.88	5.25	8.00	.66, SLOT	6.38	21.92
	MM	305	105	295	766	353	133	203	17 SLOT	162	557
323	IN	12.00	4.12	11.63	30.17	13.88	5.25	8.00	.66, SLOT	6.88	21.92
	MM	305	105	295	766	353	133	203	17 SLOT	175	557

ZP2 ZP3 PUMP DIMENSIONS

Model ZP2 / ZP3		A	B	C	D	E	F	G	H	I	J
6	IN	4.75	1.95	3.75	11.80	5.50	1.94	2.31	.41, SLOT	2.93	9.61
	MM	1.21	50	95	300	140	49	59	10, SLOT	74	244
15	IN	4.75	1.95	3.75	11.80	5.50	1.94	2.31	.41, SLOT	2.93	9.61
	MM	121	50	95	300	140	49	59	10, SLOT	74	244
18	IN	4.75	2.18	3.75	12.49	5.50	1.94	2.31	.41, SLOT	2.93	9.84
	MM	121	55	95	317	140	49	59	10, SLOT	74	250
30	IN	6.25	2.78	4.25	14.58	6.86	2.31	2.56	.41, SLOT	3.56	11.61
	MM	159	71	108	370	174	59	65	10, SLOT	90	295
40	IN	6.25	2.94	4.25	14.87	6.86	2.31	2.56	.41, SLOT	3.56	11.99
	MM	159	75	108	380	174	59	65	10, SLOT	90	305
45	IN	8.25	3.86	5.87	18.56	9.56	3.50	4.12	0.53	5.06	14.86
	MM	210	98	149	471	243	89	105	13	129	377
60	IN	8.25	4.14	5.87	19.32	9.56	3.50	4.12	0.53	5.06	15.14
	MM	210	105	149	491	243	89	105	13	129	385
130	IN	8.25	4.78	5.87	20.33	9.56	3.50	4.12	0.53	5.06	15.77
	MM	210	121	149	516	243	89	105	13	129	401
180	IN	8.50	3.45	9.00	23.53	12.38	3.75	7.25	.53, SLOT	6.38	18.25
	MM	216	88	229	598	314	95	184	13 SLOT	162	464
220	IN	8.50	3.69	9.00	24.27	12.38	3.75	7.25	.53, SLOT	6.38	18.49
	MM	216	94	229	616	314	95	184	13 SLOT	162	470
210	IN	12.00	3.45	11.63	27.08	13.88	5.25	8.00	.66, SLOT	6.88	21.24
	MM	305	88	295	688	353	133	203	17 SLOT	175	539
320	IN	12.00	3.84	11.63	27.66	13.88	5.25	8.00	.66, SLOT	6.88	21.92
	MM	305	98	295	703	353	133	203	17 SLOT	175	557

XP PUMP DIMENSIONS

Model XP		A	B	C	D	E	F	G	H	I	J
320	IN	12.00	4.12	11.63	30.17	13.88	5.25	8.00	.66, SLOT	6.88	21.92
	MM	305	105	295	766	353	133	203	17 SLOT	175	557
323	IN	12.00	4.12	11.63	30.17	13.88	5.25	8.00	.66, SLOT	6.88	21.92
	MM	305	105	295	766	353	133	203	17 SLOT	175	557
380	IN	12.00	4.13	11.63	30.28	13.88	5.25	8.00	.66, SLOT	6.88	21.95
	MM	305	105	295	769	353	133	203	17, SLOT	175	558
420/423	IN	21.00	5.60	22.00	49.60	18.75	9.00	16.50	1.06	9.75	39.22
	MM	533	142	559	1260	476	229	419	27	248	996

K	L	M	Port Size	N	O	Key	P	Q	OAH	Weight	
2.12	2.00	4.21	1"	2.79	0.875	0.1875	3.49	6.97	8.30	LB	60
54	51	107	25	71	22.2	4.76	89	177	211	KG	27
2.12	2.00	4.21	1½"	2.79	0.875	0.1875	3.49	6.97	8.30	LB	60
54	51	107	38	71	22.2	4.76	89	177	211	KG	27
212	2.00	4.21	1½"	3.02	0.875	0.1875	3.55	7.09	8.30	LB	64
54	51	107	38	77	22.2	4.76	90	180	211	KG	29
2.62	2.32	5.21	1½"	3.84	1.25	0.250	4.25	8.50	10.29	LB	130
67	59	132	38	98	31.8	6.35	108	216	261	KG	59
2.62	2.32	5.21	2"	4.00	1.25	0.250	4.31	8.62	10.29	LB	140
67	59	132	51	102	31.8	6.35	109	219	261	KG	64
3.50	2.25	7.31	2½"	5.01	1.625	0.375	5.37	10.75	15.31	LB	285
89	57	186	64	127	41.3	9.53	136	273	389	KG	129
3.50	2.25	7.31	3"	5.65	1.625	0.375	5.37	10.75	15.31	LB	305
89	57	186	76	144	41.3	9.53	136	273	389	KG	138
4.50	2.75	9.38	4"	4.44	2.00	0.500	6.63	13.25	19.13	LB	565
114	70	238	102	113	50.8	12.70	168	337	486	KG	256
5.06	4.06	10.38	6" 150# FLG	5.37	2.375	0.625	8.00	16.00	22.38	LB	900
129	103	264		136	60.3	15.88	203	406	568	KG	408
5.06	4.06	10.38	6" 150# FLG	5.37	2.375	0.625	8.00	16.00	22.38	LB	900
129	103	264		163	60.3	15.88	203	406	568	KG	408

K	L	M	Port Size	N	O	Key	P	Q	OAH	Weight	
2.12	2.00	4.21	1"	2.79	0.875	0.1875	3.49	6.97	8.30	LB	56
54	51	107	25	71	22.2	4.76	89	177	211	KG	25
2.12	2.00	4.21	1½"	2.79	0.875	0.1875	3.49	6.97	8.30	LB	60
54	51	107	38	71	22.2	4.76	89	177	211	KG	27
2.12	2.00	4.21	1½"	3.02	0.875	0.1875	3.49	6.97	8.30	LB	65
54	51	107	38	77	22.2	4.76	89	177	211	KG	30
2.62	2.32	5.21	1½"	3.84	1.25	0.250	4.25	8.50	10.29	LB	130
67	59	132	38	98	31.8	6.35	108	216	261	KG	59
2.62	2.32	5.21	2"	4.00	1.25	0.250	4.31	8.62	10.29	LB	140
67	59	132	51	102	31.8	6.35	109	219	261	KG	64
3.50	2.25	7.31	2"	4.73	1.625	0.375	5.37	10.75	15.31	LB	265
89	57	186	51	120	41.3	9.53	136	273	389	KG	120
3.50	2.25	7.31	2½"	5.01	1.625	0.375	5.37	10.75	15.31	LB	285
89	57	186	64	127	41.3	9.53	136	273	389	KG	129
3.50	2.25	7.31	3"	5.65	1.625	0.375	5.37	10.75	15.31	LB	305
89	57	186	76	144	41.3	9.53	136	273	389	KG	138
4.50	2.75	9.38	3"	4.20	2.00	0.500	6.53	13.06	19.13	LB	520
114	70	238	76	107	50.8	12.70	166	332	486	KG	236
4.50	2.75	9.38	4"	4.44	2.00	0.500	6.63	13.25	19.13	LB	590
114	70	238	102	113	50.8	12.70	168	337	486	KG	268
5.06	4.06	10.38	4"	4.70	2.38	0.625	7.38	14.75	22.38	LB	802
129	103	264	102	119	60.5	15.88	187	375	568	KG	364
5.06	4.06	10.38	6" 150# FLG	5.09	2.38	0.625	8.00	16.00	22.38	LB	850
129	103	264		129	60.5	15.88	203	406	568	KG	386

K	L	M	Port Size	N	O	KEY	P	Q	OAH	Weight	
5.06	4.06	10.38	6" 150# FLG	5.37	2.375	0.625	8.00	16.00	22.38	LB	900
129	103	264		136	60.3	15.88	203	406	568	KG	408
5.06	4.06	10.38	6" 150# FLG	5.37	2.375	0.625	8.00	16.00	22.38	LB	900
129	103	264		163	60.3	15.88	203	406	568	KG	408
5.06	4.03	10.38	6" 150# FLG	5.38	2.375	0.625	8.00	16.00	22.38	LB	1100
129	102	264		137	60.3	15.88	203	406	568	KG	499
7.69	6.04	14.25	6" 150# FLG	8.35	3.875	1.00	11.25	22.50	27.25	LB	2600
195	153	362		212	98.43	25.4	286	572	692	KG	1179

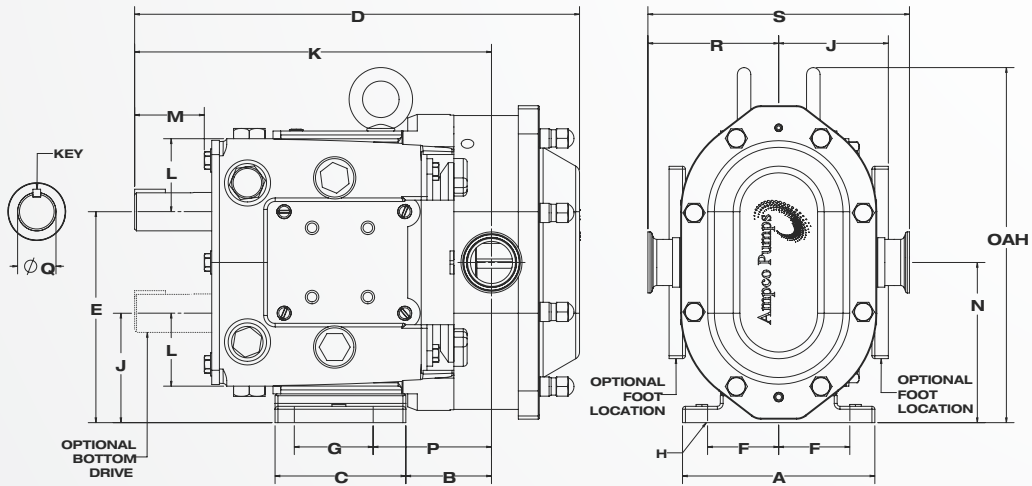

**Ampco Pumps
Company**

2045 W. Mill Road
Glendale, WI 53209
Phone: 800.737.8671
www.ampcopumps.com

Am Gäxwald 6
76863 Herxheim Germany
Phone: +49 7276 5058515
info@ampcopumps.de

**Ampco Pumps
GmbH**

ZP3 Series Positive Displacement Pumps

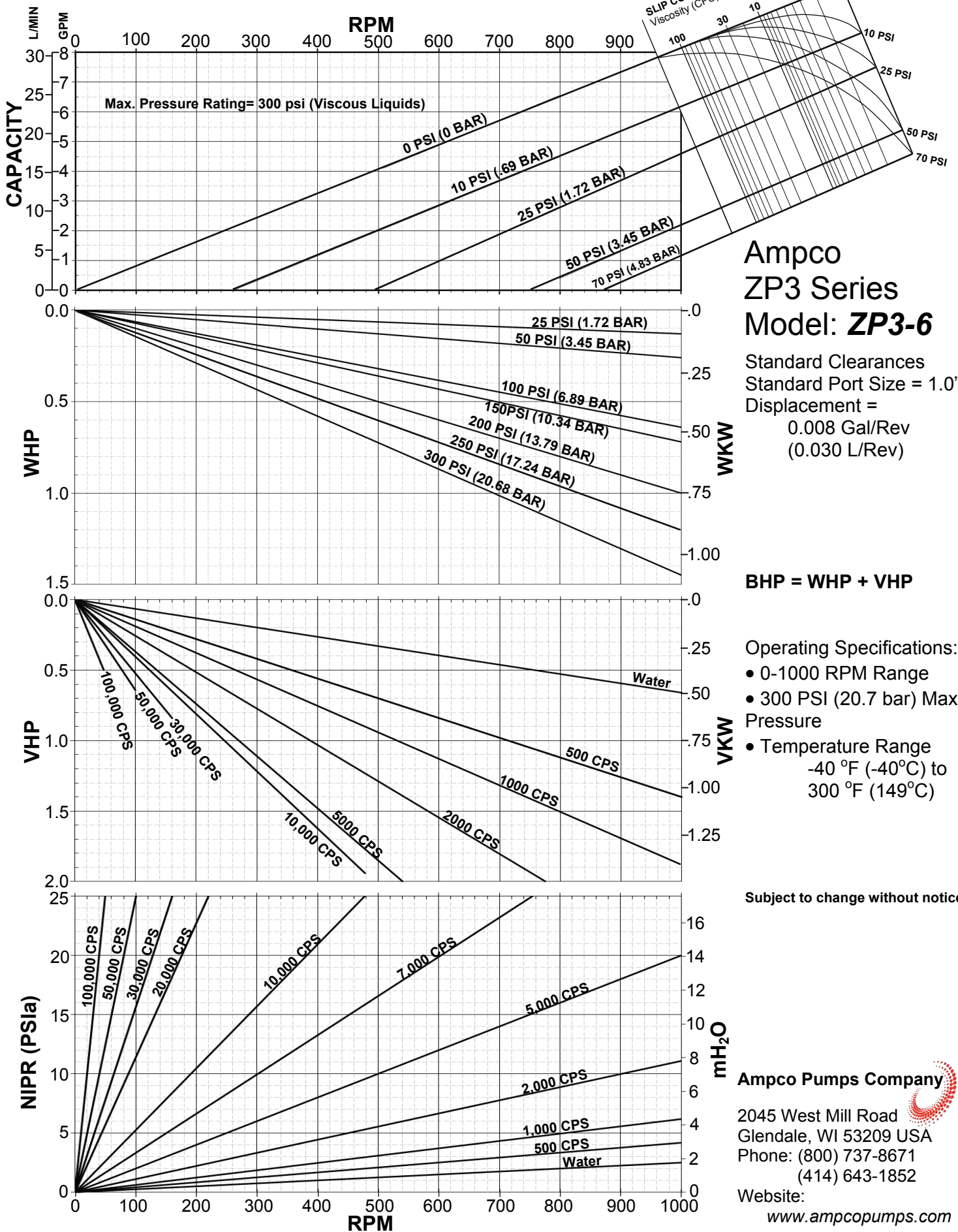

Ampco ZP3 Series Model: **ZP3-6**

Standard Clearances
Standard Port Size = 1.0"
Displacement =
0.008 Gal/Rev
(0.030 L/Rev)

BHP = WHP + VHP

- Operating Specifications:
- 0-1000 RPM Range
 - 300 PSI (20.7 bar) Max. Pressure
 - Temperature Range
-40 °F (-40°C) to
300 °F (149°C)

Subject to change without notice

Ampco Pumps Company

2045 West Mill Road
Glendale, WI 53209 USA
Phone: (800) 737-8671
(414) 643-1852

Website:
www.ampcopumps.com

ZP3 Series Positive Displacement Pumps

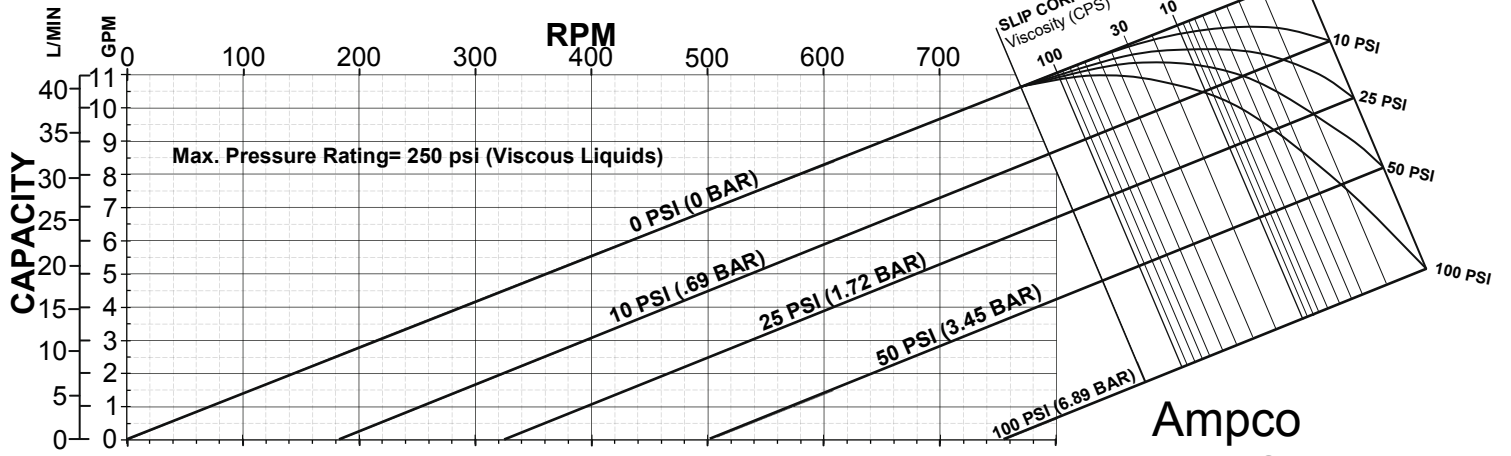

Ampco ZP3 Series Model: **ZP3-15**

Standard Clearances
Standard Port Size = 1.5"
Displacement =
0.014 Gal/Rev
(0.054 L/Rev)

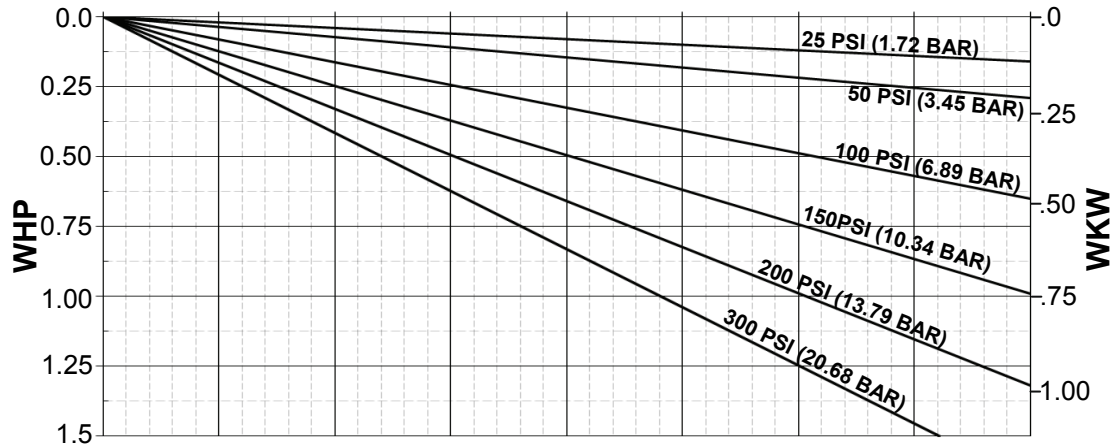

BHP = WHP + VHP

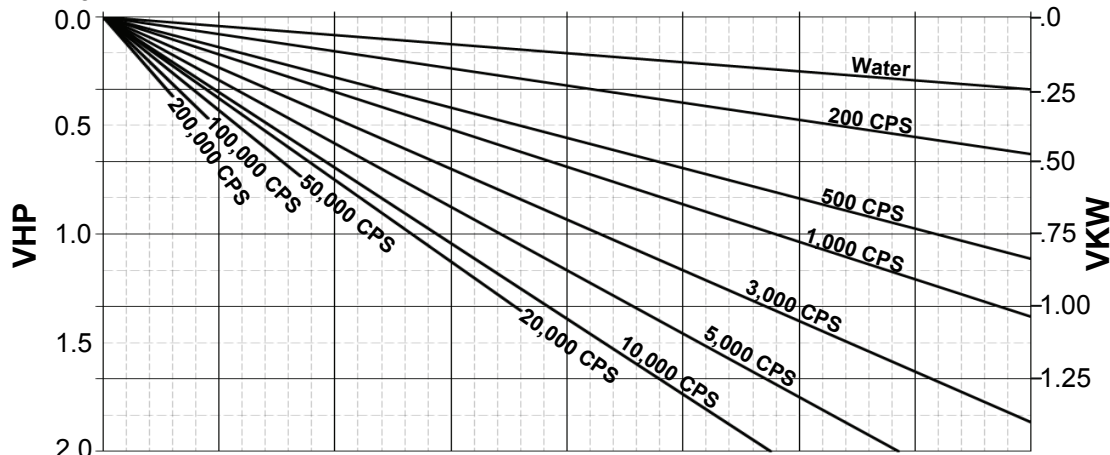

- Operating Specifications:
- 0-800 RPM Range
 - 250 PSI (17.2 bar) Max. Pressure
 - Temperature Range
-40 °F (-40°C) to
300 °F (149°C)

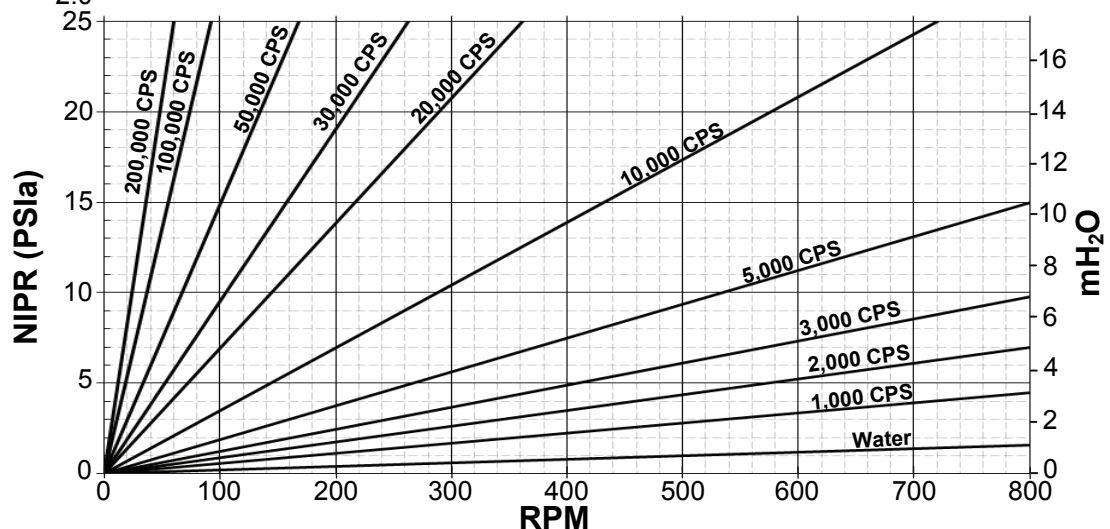

Subject to change without notice

Ampco Pumps Company

2045 West Mill Road
Glendale, WI 53209 USA
Phone: (800) 737-8671
(414) 643-1852

Website:
www.ampcopumps.com

ZP3 Series Positive Displacement Pumps

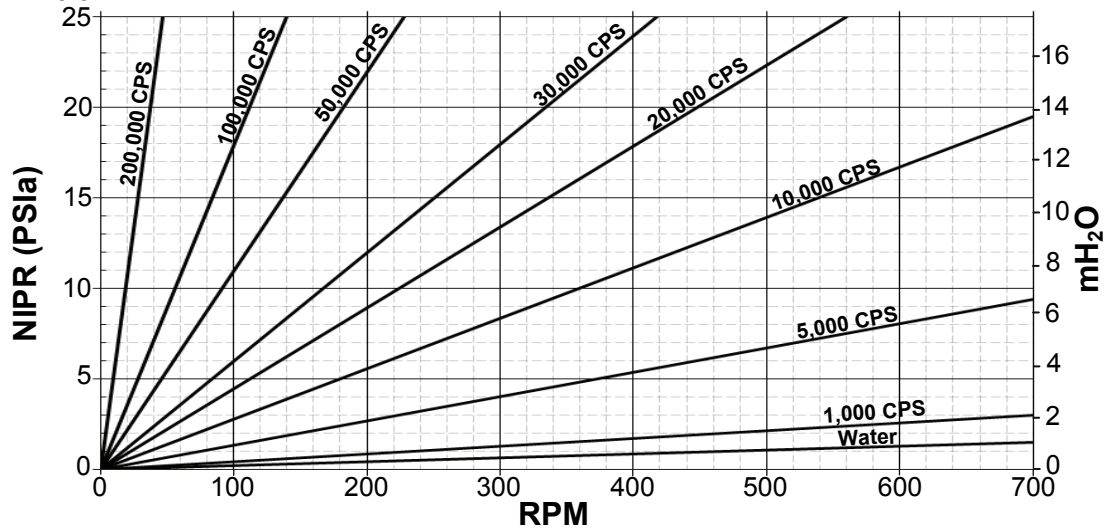
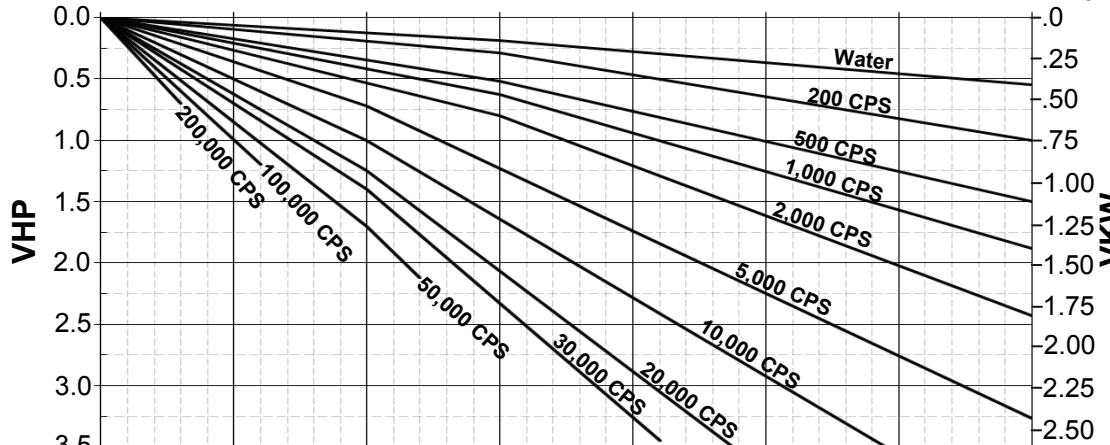
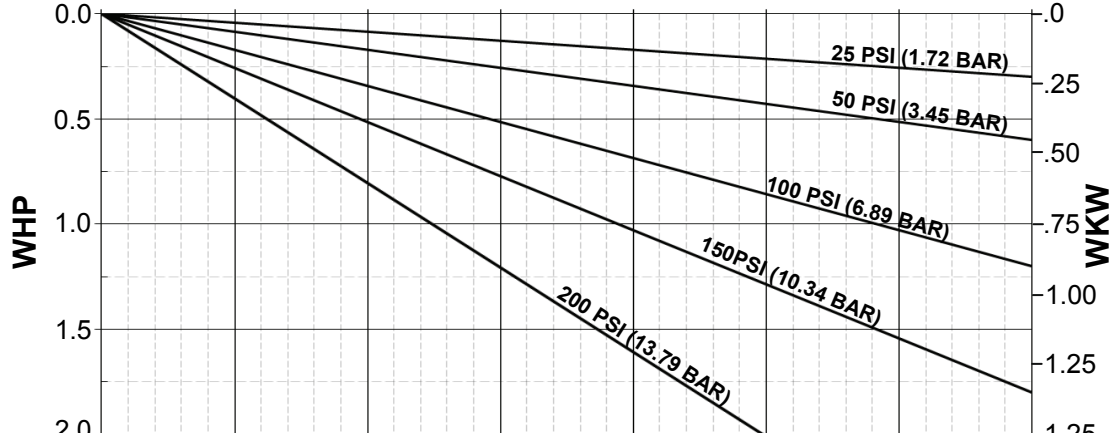
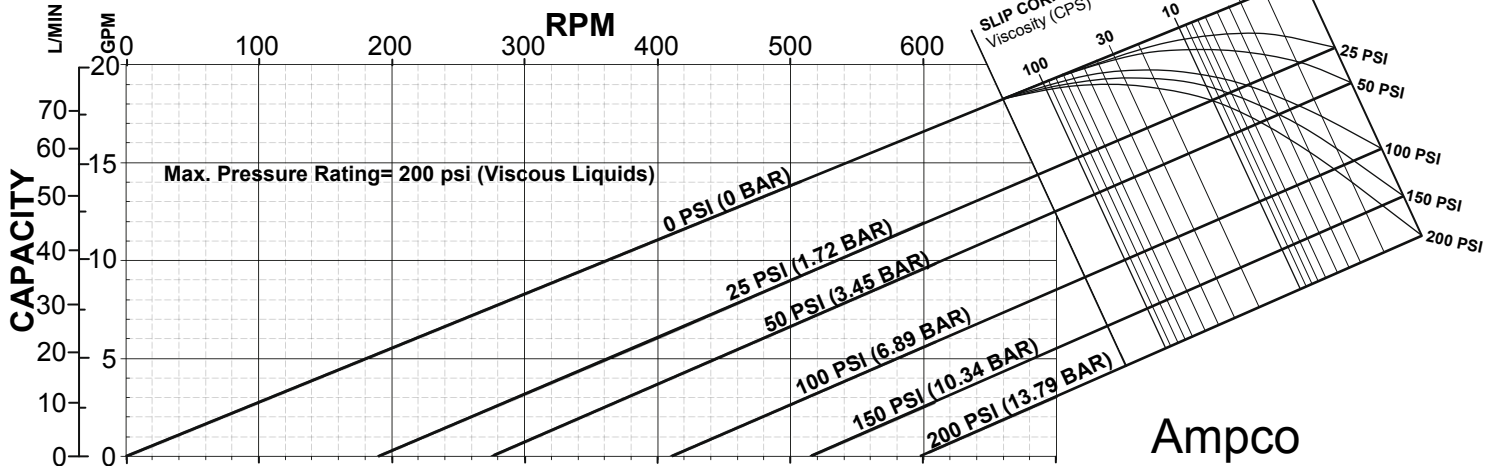

Ampco
ZP3 Series
Model: ZP3-18
 Standard Clearances
 Standard Port Size = 1.5"
 Displacement =
 0.029 Gal/Rev
 (0.108 L/Rev)

BHP = WHP + VHP
 Operating Specifications:
 • 0-700 RPM Range
 • 200 PSI (13.8 bar) Max. Pressure
 • Temperature Range
 -40 °F (-40°C) to
 300 °F (149°C)

Subject to change without notice

Ampco Pumps Company
 2045 West Mill Road
 Glendale, WI 53209 USA
 Phone: (800) 737-8671
 (414) 643-1852
 Website:
www.ampcopumps.com

ZP3 Series Positive Displacement Pumps

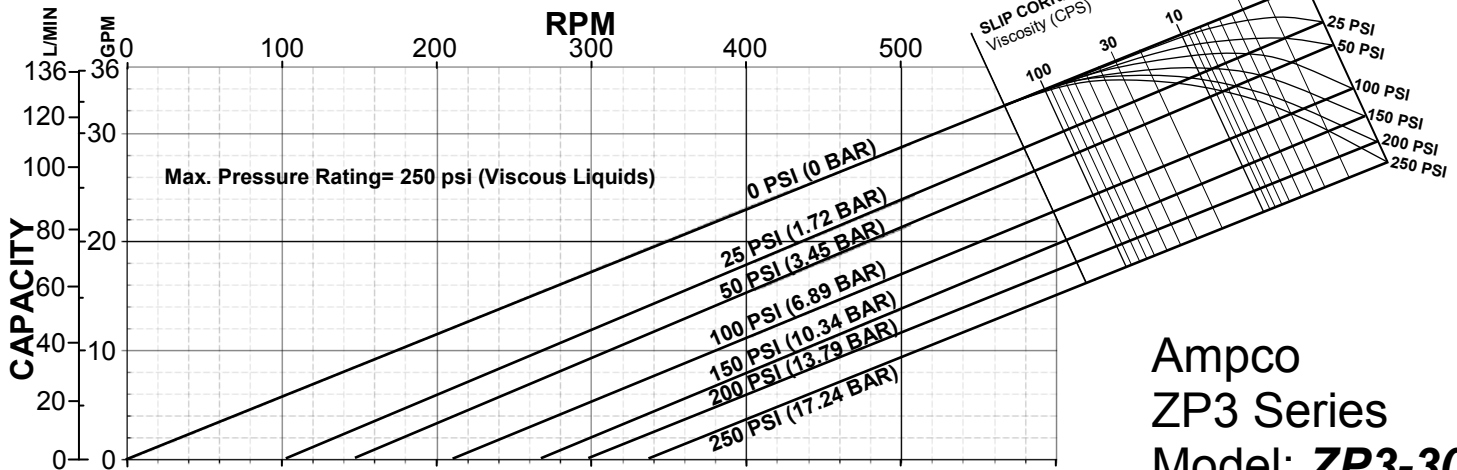

Ampco ZP3 Series Model: **ZP3-30** **ZP3-34**

Standard Clearances
Standard Port Size = 1.5"
Displacement =
0.060 Gal/Rev
(0.227 L/Rev)

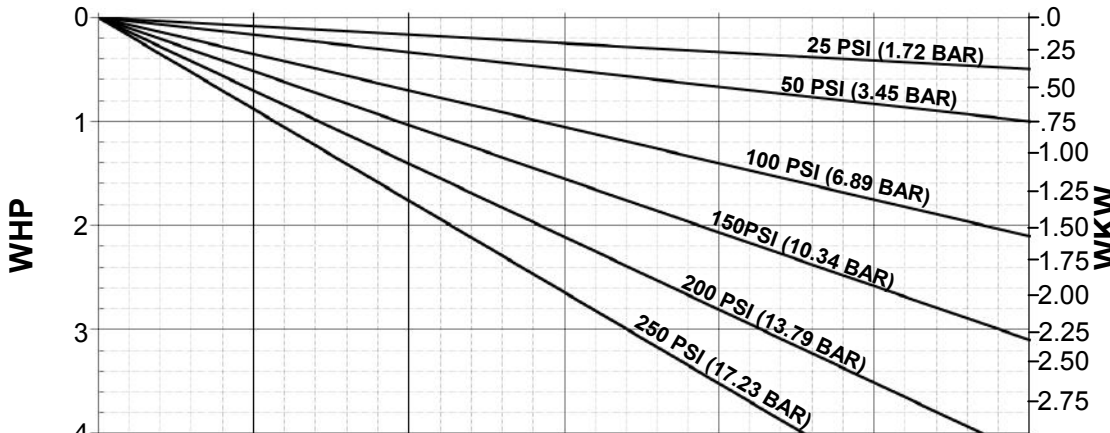

BHP = WHP + VHP

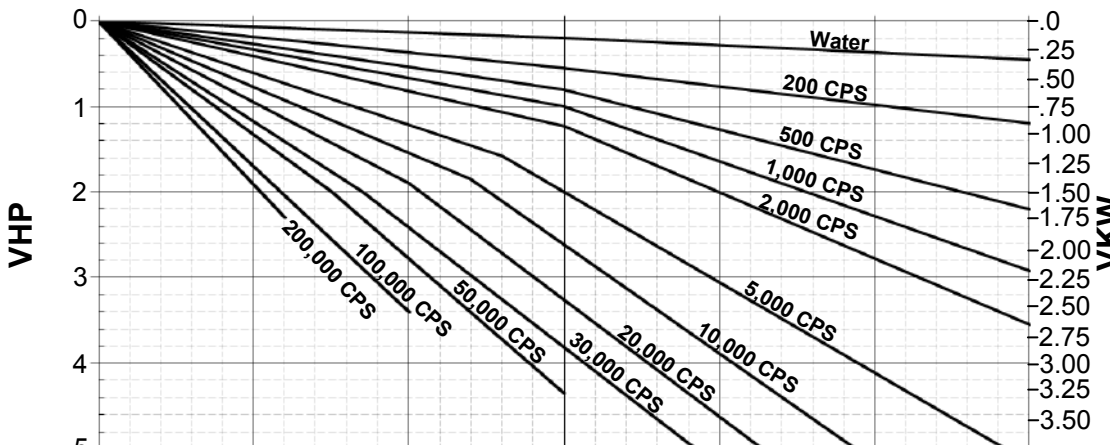

- Operating Specifications:
- 0-600 RPM Range
 - 250 PSI (17.2 bar) Max. Pressure
 - Temperature Range
-40 °F (-40°C) to
300 °F (149°C)

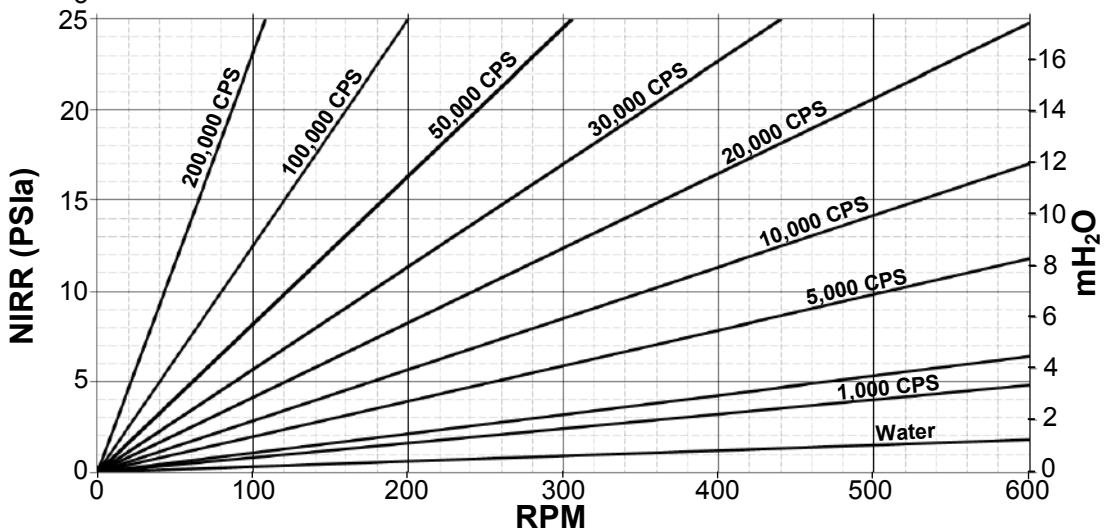

Subject to change without notice

Ampco Pumps Company

2045 West Mill Road
Glendale, WI 53209 USA
Phone: (800) 737-8671
(414) 643-1852

Website:
www.ampcopumps.com

ZP3 Series Positive Displacement Pumps

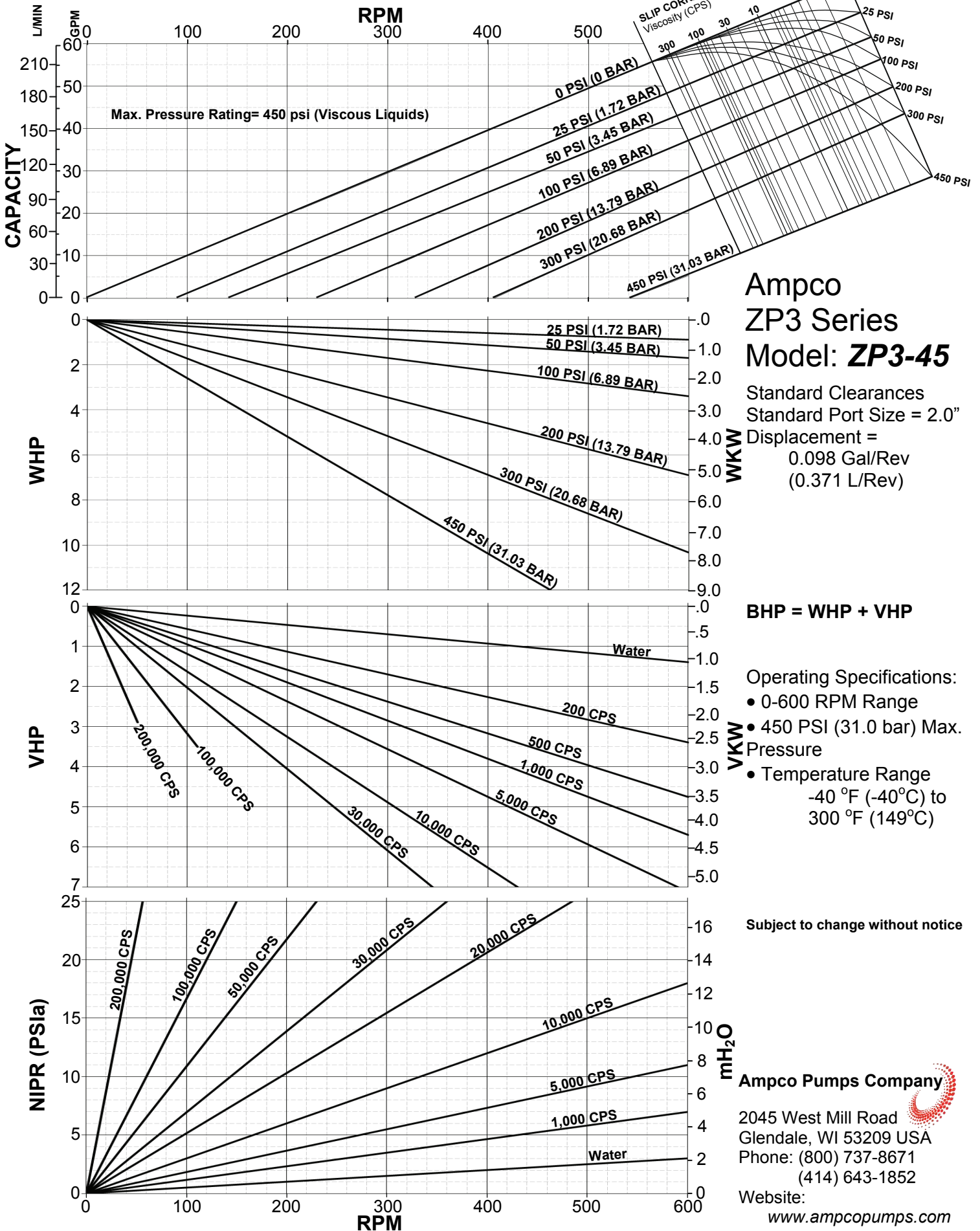

Ampco ZP3 Series Model: **ZP3-45**

Standard Clearances
Standard Port Size = 2.0"
Displacement =
0.098 Gal/Rev
(0.371 L/Rev)

BHP = WHP + VHP

- Operating Specifications:
- 0-600 RPM Range
 - 450 PSI (31.0 bar) Max. Pressure
 - Temperature Range
-40 °F (-40°C) to
300 °F (149°C)

Subject to change without notice

Ampco Pumps Company

2045 West Mill Road
Glendale, WI 53209 USA
Phone: (800) 737-8671
(414) 643-1852

Website:
www.ampcopumps.com

ZP3 Series Positive Displacement Pumps

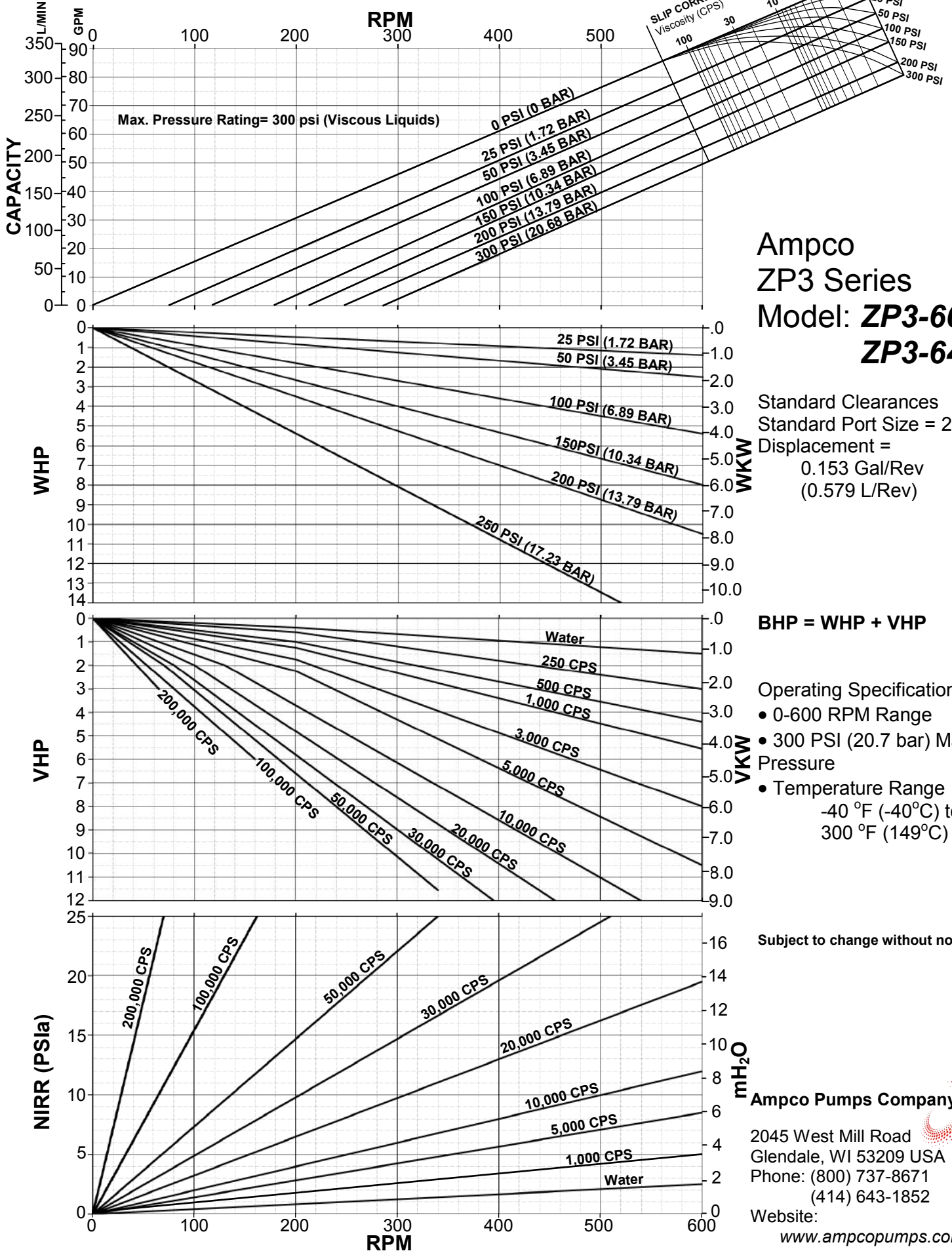

Max. Pressure Rating= 300 psi (Viscous Liquids)

Ampco ZP3 Series Model: **ZP3-60** **ZP3-64**

Standard Clearances
Standard Port Size = 2.5"
Displacement =
0.153 Gal/Rev
(0.579 L/Rev)

BHP = WHP + VHP

- Operating Specifications:
- 0-600 RPM Range
 - 300 PSI (20.7 bar) Max. Pressure
 - Temperature Range
-40 °F (-40°C) to
300 °F (149°C)

Subject to change without notice

Ampco Pumps Company

2045 West Mill Road
Glendale, WI 53209 USA
Phone: (800) 737-8671
(414) 643-1852

Website:
www.ampcopumps.com

ZP3 Series Positive Displacement Pumps

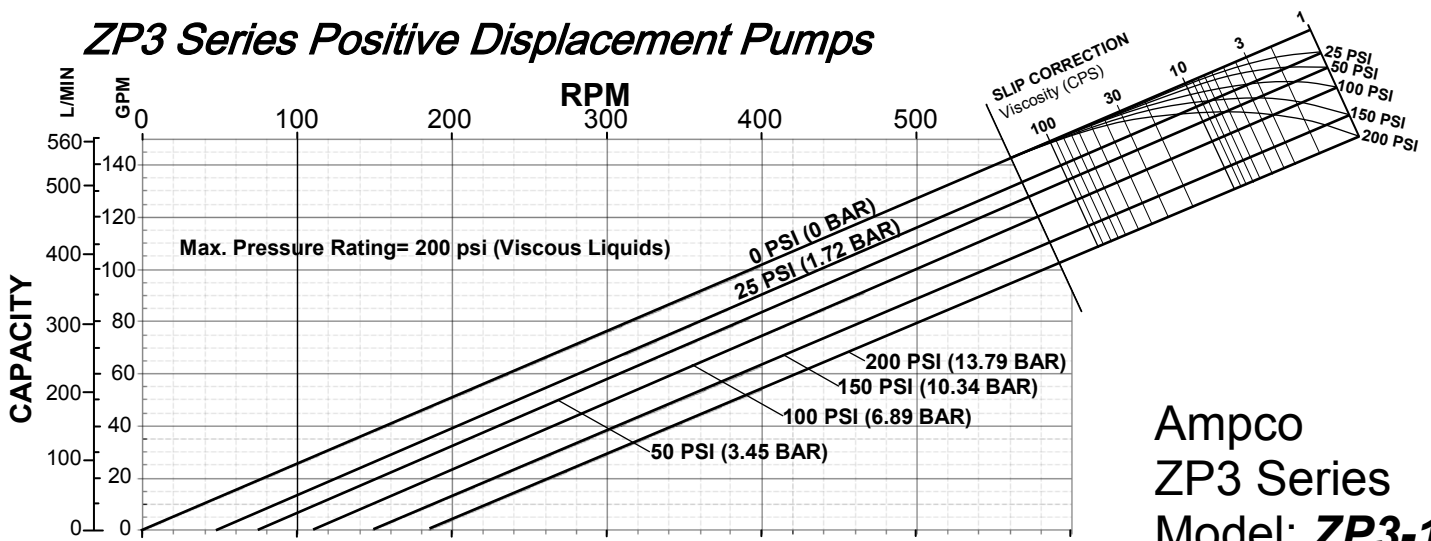

Ampco ZP3 Series Model: **ZP3-130** **ZP3-134**

Standard Clearances
Standard Port Size = 3.0"
Displacement =
0.253 Gal/Rev
(0.958 L/Rev)

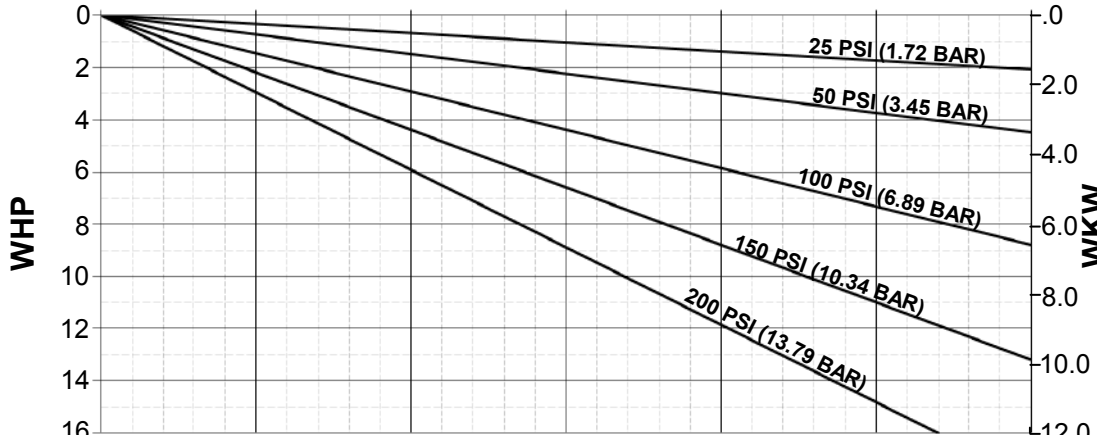

BHP = WHP + VHP

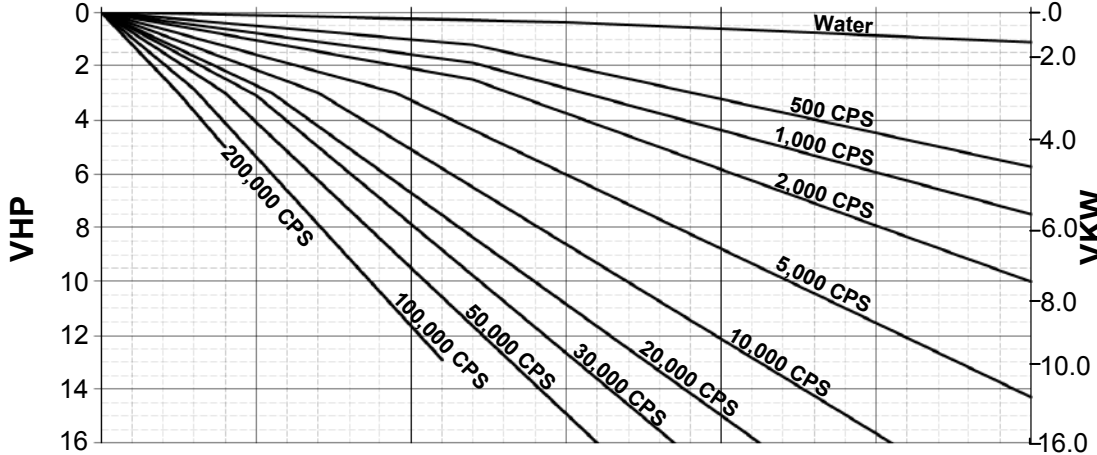

- Operating Specifications:
- 0-600 RPM Range
 - 200 PSI (13.8 bar) Max. Pressure
 - Temperature Range
-40 °F (-40°C) to
300 °F (149°C)

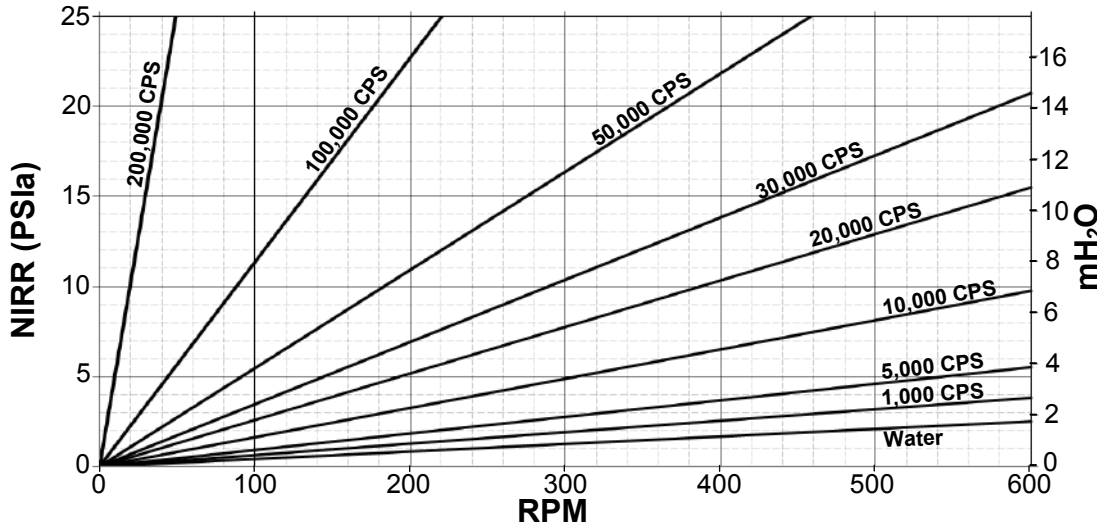

Subject to change without notice

Ampco Pumps Company

2045 West Mill Road
Glendale, WI 53209 USA
Phone: (800) 737-8671
(414) 643-1852

Website:
www.ampcopumps.com

ZP3 Series Positive Displacement Pumps

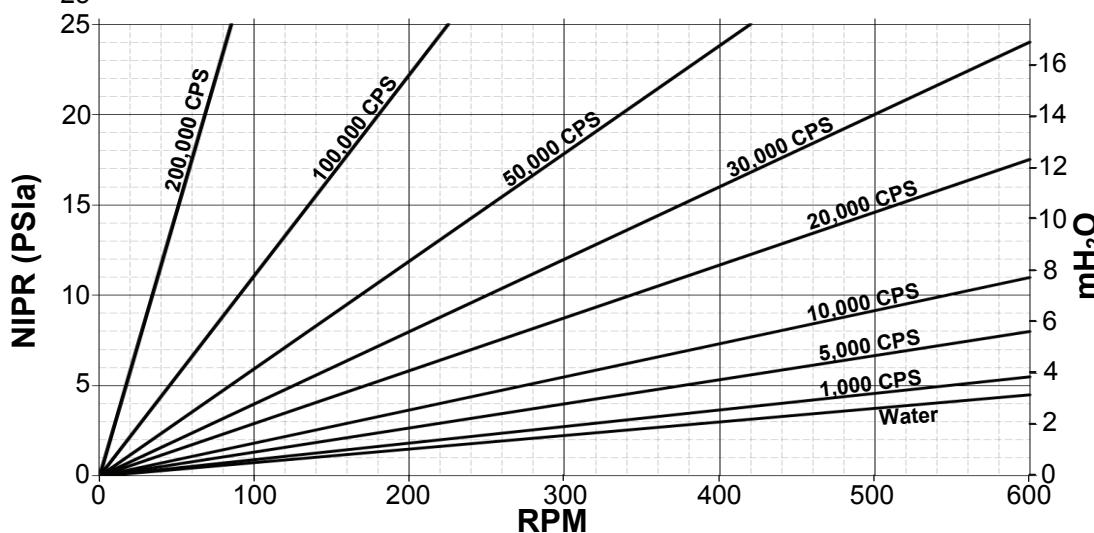
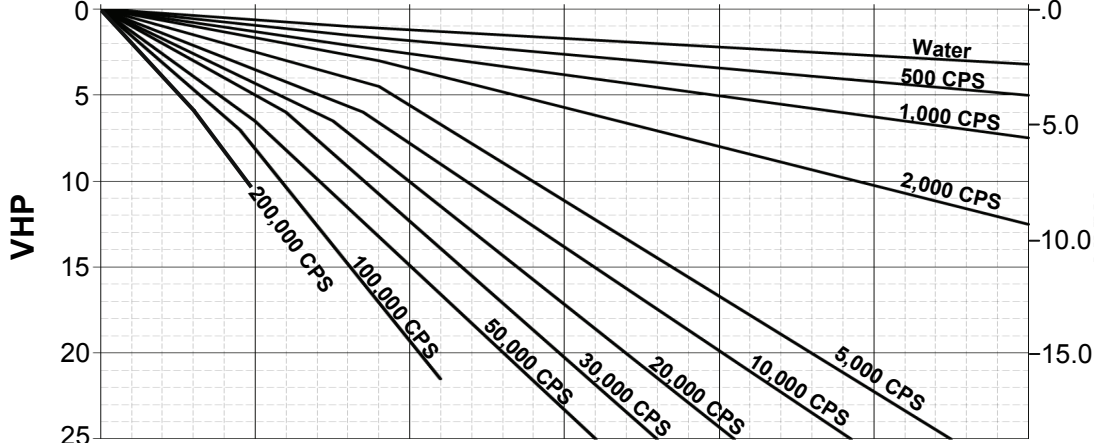
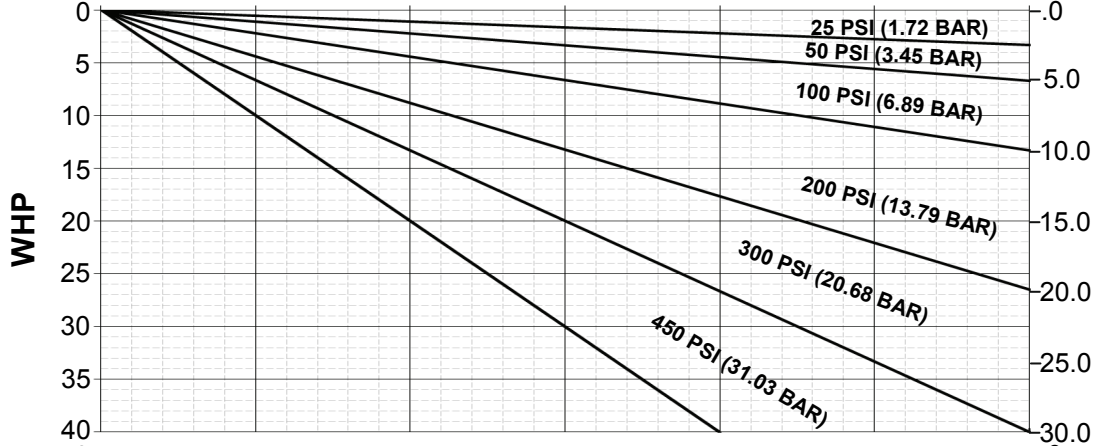
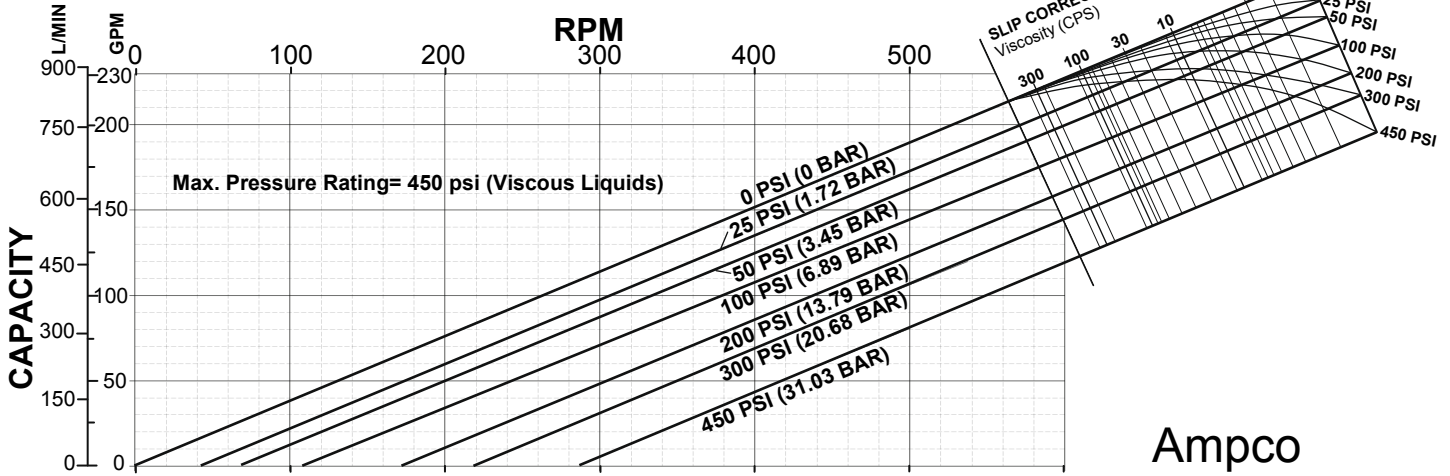

Ampco ZP3 Series Model: **ZP3-180**

Standard Clearances
Standard Port Size = 3.0"
Displacement =
0.380 Gal/Rev
(1.438 L/Rev)

BHP = WHP + VHP

- Operating Specifications:
- 0-600 RPM Range
 - 450 PSI (31.0 bar) Max. Pressure
 - Temperature Range
-40 °F (-40°C) to
300 °F (149°C)

Subject to change without notice

Ampco Pumps Company

2045 West Mill Road
Glendale, WI 53209 USA
Phone: (800) 737-8671
(414) 643-1852

Website:
www.ampcopumps.com

ZP3 Series Positive Displacement Pumps

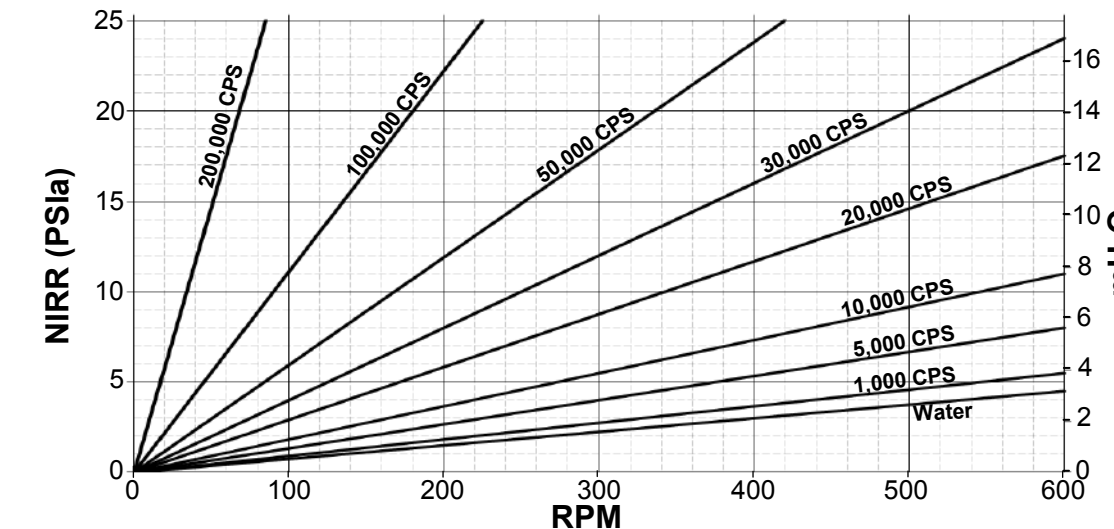
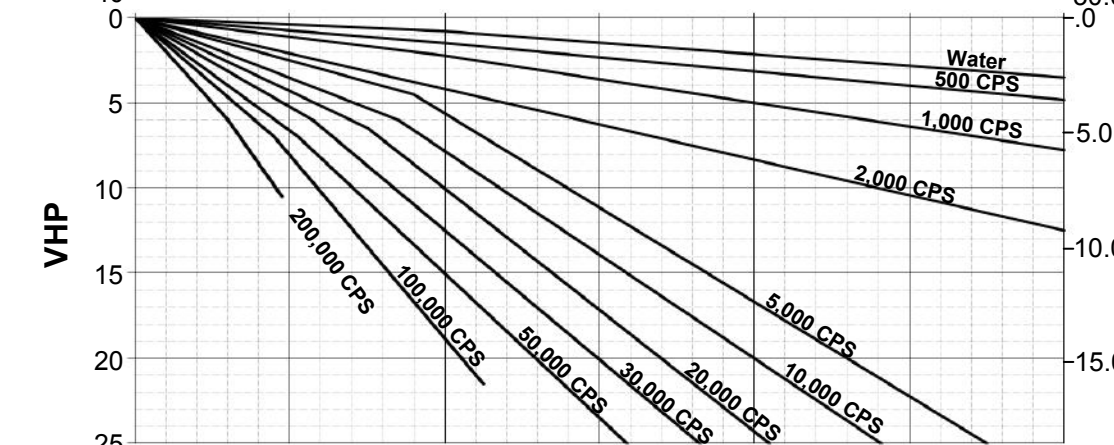
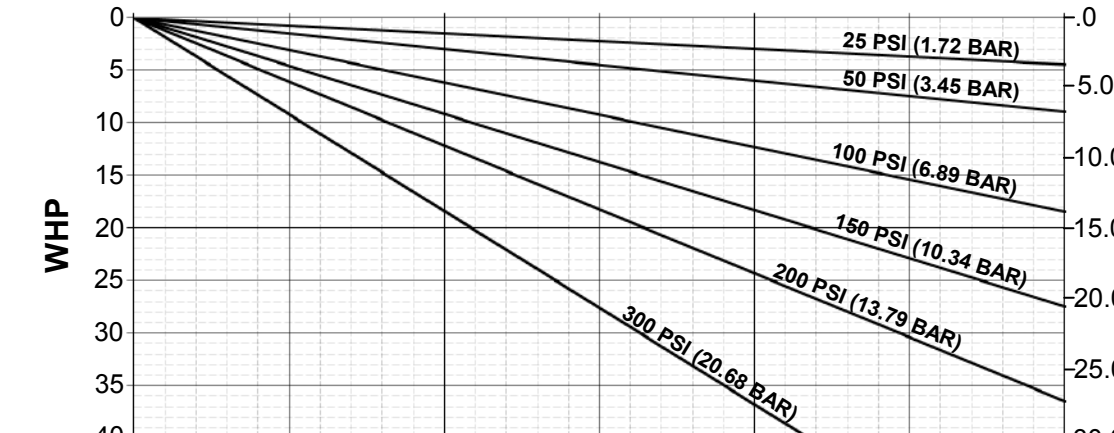
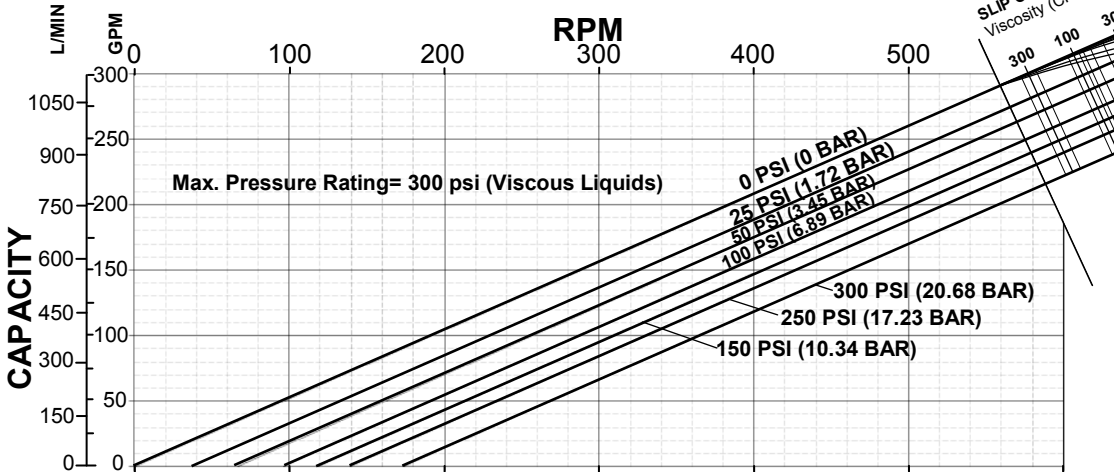

Ampco ZP3 Series Model: **ZP3-220** **ZP3-224**

Standard Clearances
Standard Port Size = 4.0"
Displacement =
0.521 Gal/Rev
(1.972 L/Rev)

BHP = WHP + VHP

- Operating Specifications:
- 0-600 RPM Range
 - 300 PSI (20.68 bar) Max. Pressure
 - Temperature Range -40 °F (-40°C) to 300 °F (149°C)

Subject to change without notice

Ampco Pumps Company

2045 West Mill Road
Glendale, WI 53209 USA
Phone: (800) 737-8671
(414) 643-1852

Website:
www.ampcopumps.com

ZP2 Exploded View
See Page 2 for ZP3 Seal
Assembly

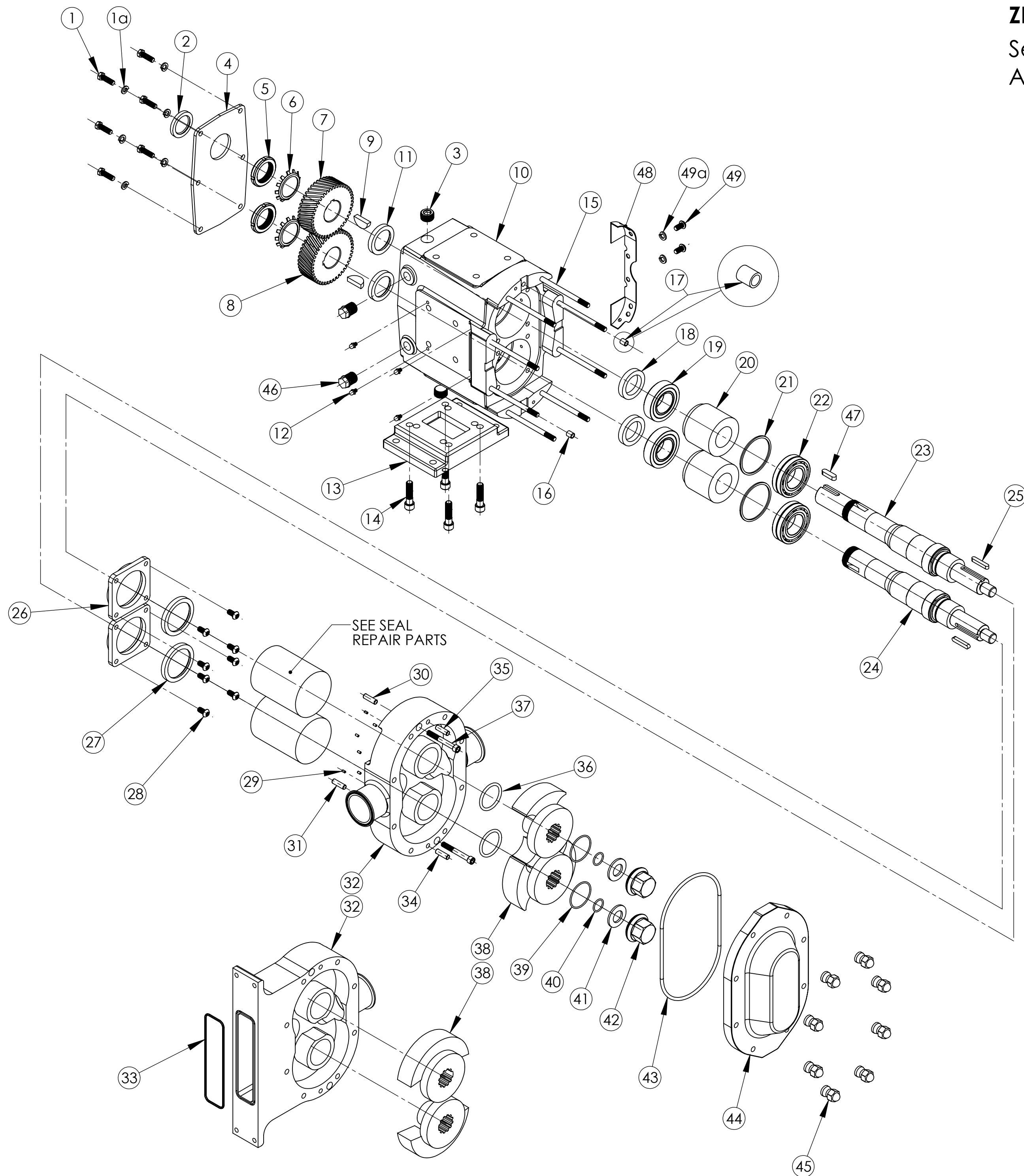

Ampco Pumps Company

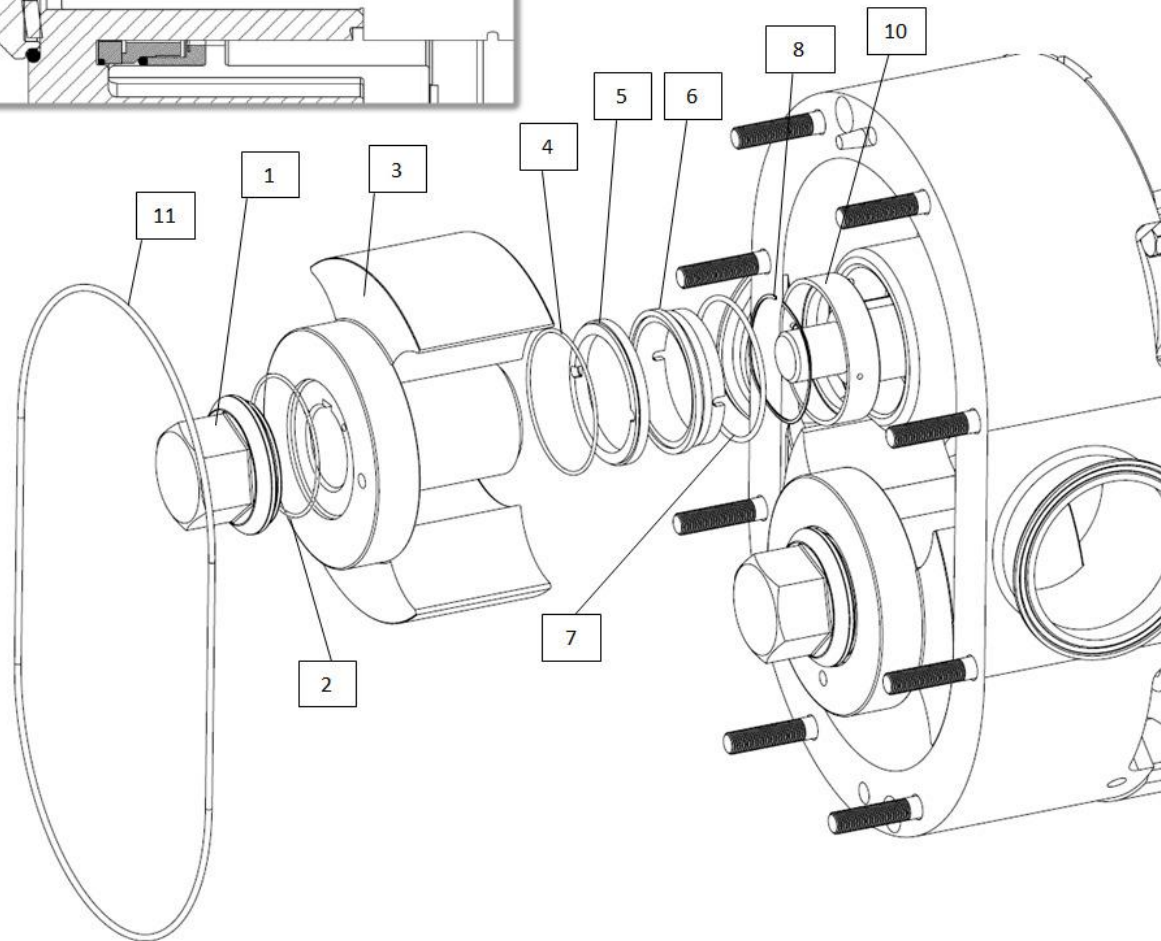
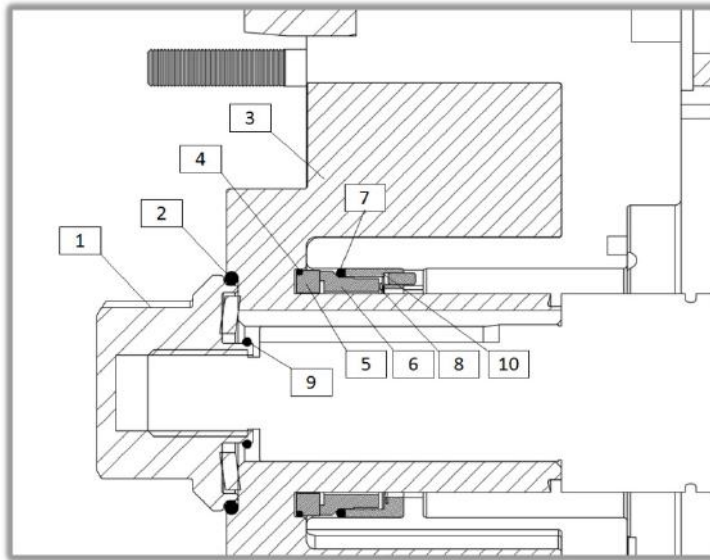

	Part
1	Rotor Nut Assembly
2	Rotor Nut O-ring
3	ZP3 Rotor
4	Rotating Seal O-ring
5	Rotating Seal
6	Stationary Seal
7	Stationary Seal O-ring
8	Wave Spring
9	Rotor Nut O-ring (small)
10	Seal Sleeve
11	Front Cover O-ring

ZP3 Seal Assembly (Single)



ZP3 Seal Assembly (Rear Seal)

	Part
12	Rear wave spring
13	Rear Stationary Seal
14*	Rear Rotating Shaft O-ring
15*	Rear Rotating Seal
16	Rear Stationary O-ring

* Install on shaft

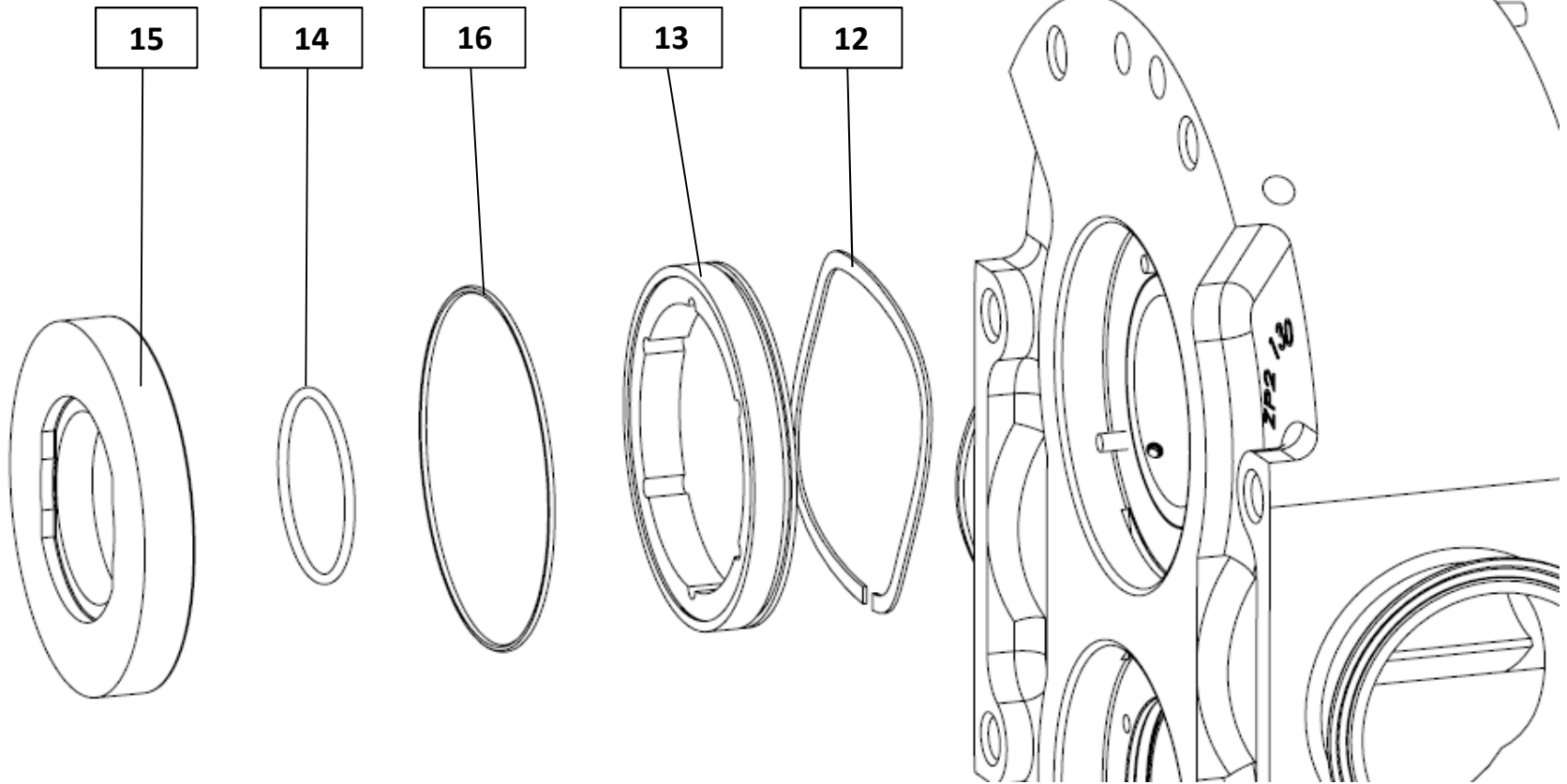

In Stock Positive Displacement Pumps

Ready for immediate shipment ZP1 & ZP3

- All pumps have standard seal configuration
- ZP1 – Single O-Ring / ZP3 – Single Mechanical
- ALL bodies have been drilled for flush

For more information:
Contact your Regional Sales Manager
Email – sales@ampcopumps.com
Call – **800.737.8671**

Glendale, Wisconsin
Available stock

ZP1	ZP3
ZP1-030-SO	ZP3-030-SM
ZP1-060-SO	ZP3-060-SM
ZP1-130-SO	ZP3-130-SM
ZP1-220-SO	ZP3-220-SM
ZP1-320-SM	

Stockton, California
Available stock

ZP1	ZP3
	ZP3-030-SM
	ZP3-060-SM
ZP1-130-SO	
ZP1-220-SO	
ZP1-320-SM	

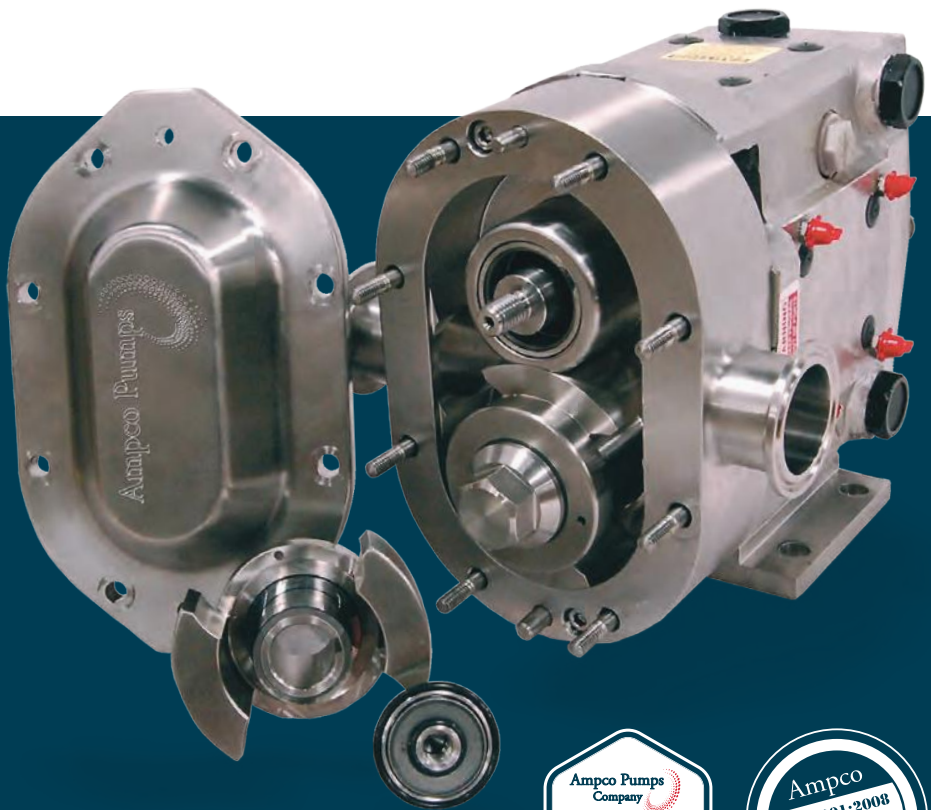

ZP-CC

Space saving design reduces footprint by as much as 25%

FEATURES

- Multiple horsepower and gear ratio options
- Optional custom stainless base
- Self-aligning design eliminates misalignment issues
- Coupling and guard not required, right angle reducer can further increase space savings
- Improved clean-ability over traditional pump packages

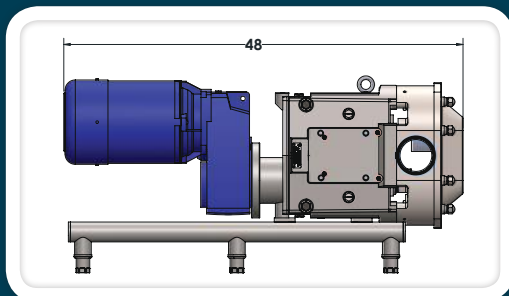
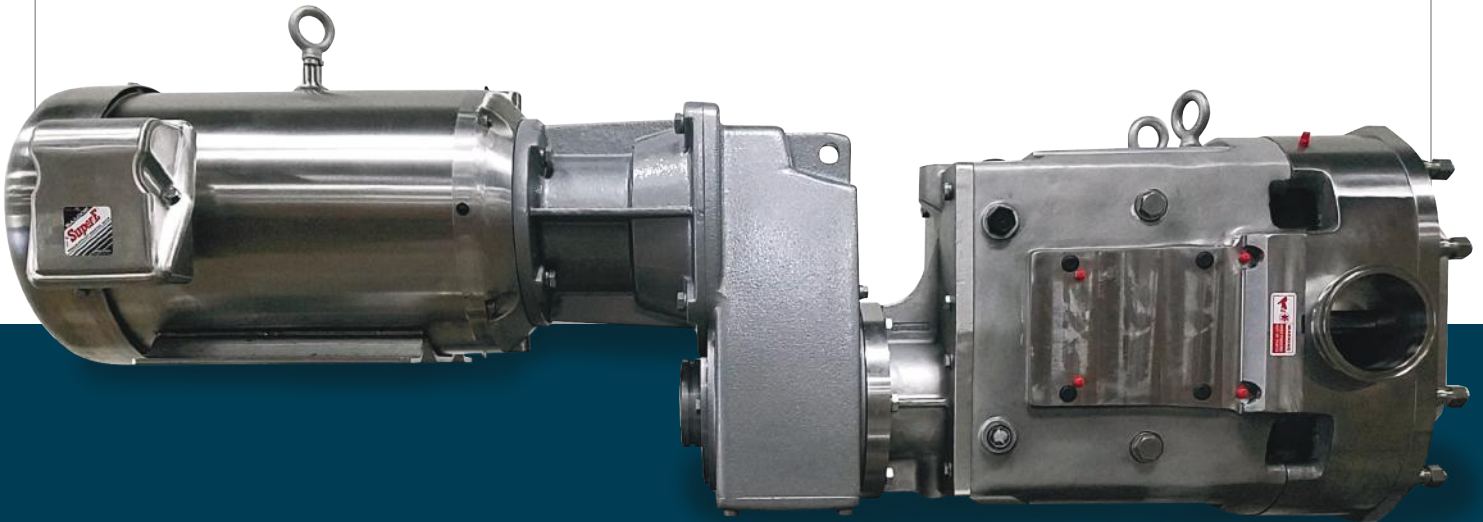

ZP-CC Dimension

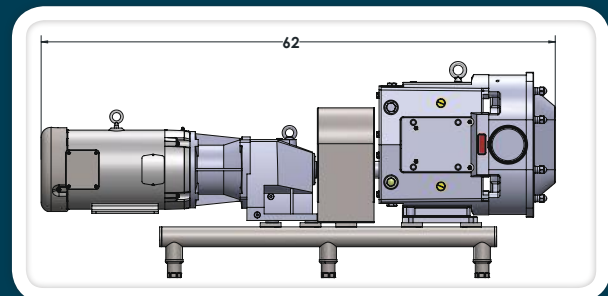

Standard Long Coupled Dimension