

Rotary Drive Products

Gears, Bearings, Couplings and Shaft Accessories



Boston Gear

Boston Gear offers the industry's largest line up of reliable speed reducers, gearing and other quality drivetrain components.

With more than 125 years of frontline experience, Boston Gear is recognized globally as a premier resource for extremely reliable, high-performance power transmission components. Boston Gear offers the industry's most comprehensive product array featuring more than 30,000 standard products combined with the ability to custom engineer unique solutions when required. Product lines include standard enclosed gear drives, custom speed reducers, AC/DC motors, DC drives and Centric brand overload clutches and torque limiters.

VISIT US ON THE WEB AT
BOSTONGEAR.COM



Altra Motion

Altra is a leading global designer and producer of a wide range of electromechanical power transmission and motion control components and systems. Providing the essential control of equipment speed, torque, positioning, and other functions, Altra products can be used in nearly any machine, process or application involving motion. From engine braking systems for heavy duty trucks to precision motors embedded in medical robots to brakes used on offshore wind turbines, Altra has been serving customers around the world for decades.

Altra's leading brands include **Ameridrives**, **Bauer** Gear Motor, **Bibby** Turboflex, **Boston** Gear, **Delevan**, **Delroyd** Worm Gear, **Formsprag** Clutch, **Guardian** Couplings, **Huco**, **Jacobs** Vehicle Systems, **Kilian**, **Kollmorgen**, **Lamiflex** Couplings, **Marland** Clutch, **Matrix**, **Nuttall** Gear, **Portescap**, **Stieber**, **Stromag**, **Svendborg** Brakes, **TB Wood's**, **Thomson**, **Twiflex**, **Warner** Electric and **Wichita** Clutch.

VISIT US ON THE WEB AT **ALTRAMOTION.COM**



Table Of Contents

Stock Altered and Custom Worm and Worm Gears.....	3-5
Selection and Reference Guide	6-12
Product Descriptions	13-16
A SPUR GEARS	
Section Contents	17
Pinions and Spur Gears	18-27, 37-46
Change Gears	28-32
Stem Pinions	33
Drawn Pinion Wire	34
Rack	35, 47
Internal Gears.....	36, 48
Selection.....	49-62
Gear Gauge Sets.....	62
B HELICAL GEARS	
Section Contents	63
Helical Gears	64-65
Selection.....	66-68
Stock Altered and Custom Helical Gears	3-5
C MITER AND BEVEL GEARS	
Section Contents	69
Miter Gears.....	70-73
Bevel Gears	74-78
Selection.....	79-83
Stock Altered and Custom Miter & Bevel Gears	3-5
D WORMS AND WORM GEARS	
Section Contents	85
Worms and Worm Gears.....	86-95
Selection.....	96-98
E SHAFT ACCESSORIES	
Selection Contents	99
Shaft Couplings	100-106
Universal Joints	107-113
Shaft Collars, Set Screw and Clamping Collars.....	114-117
Washers and Bushings	118-119
Pulleys, Round Belt	120
Miniature Timing Belt & Pulley Selection	121-134
F BEARINGS	
Selection Contents	135
BOST-BRONZ (Oil-Impregnated Sintered Bronze)	136-144
BEAR-N-BRONZ (660 Cast Bronze).....	145-153
Bronze Bearing Emergency Bank.....	154
BOSTonE F-1 (Glass Filled Teflon).....	155-157
RULON® 641 Bearings	158-159
BOSTonE Molded Plastic	160-171
BOSTonE Molded Nylon	172-173
Sleeve Bearing Engineering	174-182
Anti-Friction (Ball Bearings)	183-197
Self-Aligning (Rod End & Spherical Bearings).....	198-206
Engineering.....	207-211
Mounted Bearings.....	212-232
Stainless Mounted Bearings	233-238
Rolling Element Bearing Engineering.....	239-245
G CHAINS	
Section Contents.....	249
Roller Chains.....	253-260
Block Chains	261

Continued on next page

Table Of Contents Continued

G CHAINS (continued)	
Leaf (Cable) Chains	261
Ladder Chains	262
Miniature Roller Chains.....	263
Chain Pullers/Chain Breaking Tools.....	264
H SPROCKETS	
Section Contents.....	265
Roller Chain Drives	266-273
Miniature Chain Sprockets.....	274
Roller Chain Sprockets.....	275-297
Block Chain Sprockets	298
Ladder Chain Sprockets.....	299-300
Roller Chain Drive Tensioners	301-304
Idle Sprockets	301
I ENGINEERING INFORMATION	
SPUR GEARS	
Nomenclature	306-307
Involute Form	308
Diametral Pitch / Pressure Angle / Tooth Dimensions.....	309
Backlash / Undercut / Formulas.....	310
Lewis Formula	311
HELICAL GEARS	
Nomenclature / Helix Angle	312
Formulas	313
Thrust Loads.....	314
MITER & BEVEL GEARS	
Nomenclature	315
Mounting Distance	316
Tooth Strength / Thrust	317
WORMS & WORM GEARS	
Hand / Efficiency / Thrust Loads	318
Formulas / Self-Locking	319
COUPLING / UNIVERSAL JOINTS	320
GENERAL INFORMATION	
How To Figure Horsepower & Torque	321
Mountings / Alterations / Lubrication	322
Materials / Styles / Keyways & Setscrews	323
Sprockets, Sprocket Diameters.....	324-326
Horsepower & Torque Capacity Of Shafting	327
Temperature Conversion Table	328
Equivalent Table	329
Metric Conversion Chart	330
Application Classifications.....	331-332
INDEX TO CATALOG NUMBERS	333-336

Modified Stock Gearing

With thousands of stock gears available, chances are we've got just what you're looking for. If you find a stock gear that's close to what you need, but not precisely right, that's not a problem. We can modify most stock gears to meet your requirements and ship it within 24 hours. The full range of modifications we can provide are shown below.

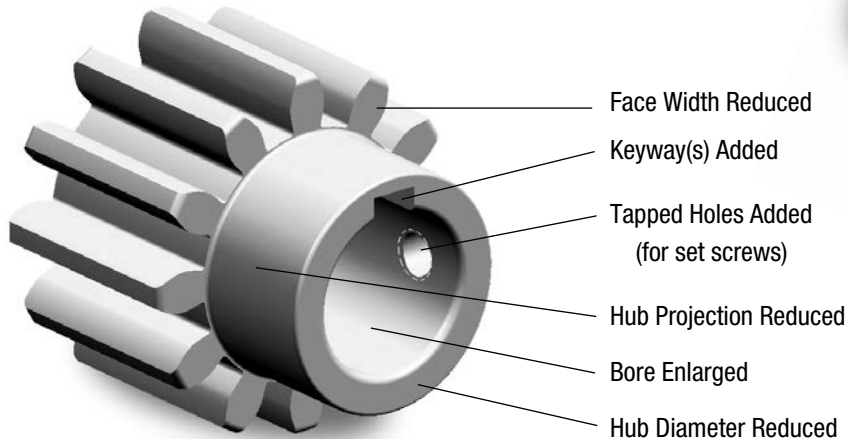

Keyways and bores available in common metric sizes.

**24 HOUR
MODIFIED STOCK GEARING
SHIPMENT**

With Boston Gear, stock gear modifications are quick and easy. Give us a call at **800-825-6544**.

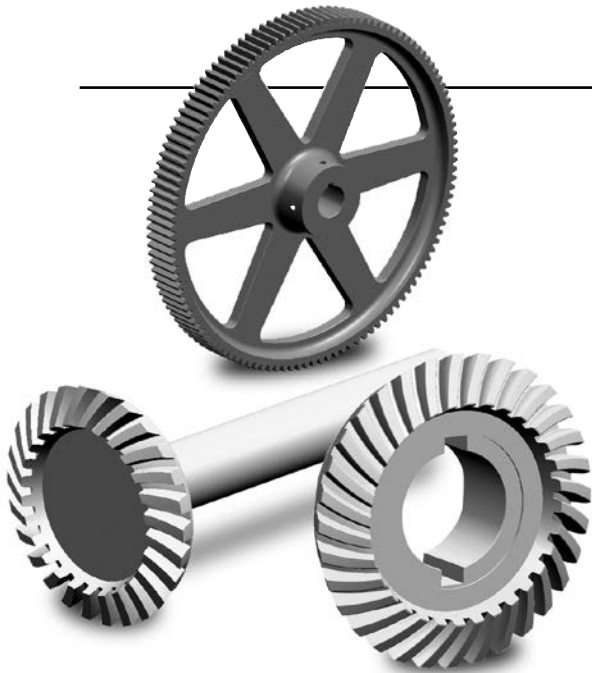

Custom Gearing

Not every job is alike and not every job requires the same solution. That's why Boston Gear will configure a custom gear to suit you. Even though we have built our reputation on supplying a breadth of standard products for virtually any industry, we have forged a name for ourselves as makers of quality custom gears. Custom doesn't have to mean expensive and it doesn't have to mean that it requires long lead times.

Depending on the amount of tooling required and the complexity of the job, your custom gear solution can be delivered in days, not weeks. No matter how small or how large your job is, contact our custom engineering team for a customized quote.

To request a quote for a custom gear solution from Boston Gear, simply fill out the "Request For Quotation Form" on page 5, and **FAX to 800-387-0130**. Or give us a call at 800-816-5608.

Custom Gearing Capabilities

Gear Types

- Spur
- Helical
- Miter & Bevel
- Worm & Worm Gear

AGMA Classes

AGMA 9 Non-Heat Treated, Spur & Helical Gears only

AGMA 8 Heat Treated & Non-Heat Treated, all other gears

Note: Worm & Worm Gears do not have AGMA Class listings, however Boston Gear manufacturing tolerances relate to AGMA 8.

Capabilities

Gear Type	Diametral Pitch	Pitch Diameter	Face Max.
Spur	64DP-3DP	.250"-36.000"	5.000"
Helical	64DP-3DP	.337"-24.000"	5.000"
Internal Spur	64DP-3DP	1.000"-24.000"	5.000"
Bevel & Miter	64DP-3DP	.500"-24.000"	3.000"
Worm	48DP-3DP	.333"-4.000"	12.000"
Worm Gear	48DP-3DP	.420"-24.000"	5.000"
Splines	Consult Engineering		

Module	Diametral Pitch	Circular Pitch (in.)
.4	63.500	.0495
.5	50.800	.0618
.6	42.333	.0742
.8	31.750	.0989
1	25.400	.1237
1.25	20.320	.1546
1.5	16.933	.1855
2	12.700	.2474
2.5	10.160	.3092
3	8.467	.3711
4	6.350	.4947
5	5.080	.6184
6	4.233	.7422
8	3.175	.9895

Note: Circular Pitch (.0491"-1.0472") or Module Pitch (.4mm-8mm) within the Diametral Pitch Limits are optional (refer to page 309).

Tolerances

Features	≤ 2" Diameter	≥ 2" Diameter
Bore Diameter	.0005"	.0010"
Ground O.D.	.0005"	.0010"
Turned O.D.	.0020"	.0020"
Bore Length	.0020"	.0020"
Keyway Width	.0020"	.0020"
Keyway Depth	.0100"	.0100"
Tapped Holes	2B Thread	

Geometric Dimensioning

Features	≤ 2" Diameter	≥ 2" Diameter
Perpendicularity	.0010"	.0010"
Parallelism	.0010"	.0010"
Circular Runout	.0010"	.0010"
Flatness	.0010"	.0010"
Concentricity	.0005"	.0010"

Backlash

Refer to Engineering Information found on pages 310 and 309.

Refer to engineering for backlash related to helical and worm gearing.

Lot Sizes

25 pcs Minimum Quantity on 6" OD and less

Finishes

63 RMS Minimum on gear teeth

32 RMS Minimum on Bores, Shaved Gear Teeth, Ground Worms, and Machined Surfaces







Material

Description	Designation
Low Carbon Steels	11L17, 12L14, 12L15
Medium Carbon Steels	11L41, 1045
Low Carbon Alloy Steels	86(L)20* (*86L20 or 8620)
Medium Carbon Alloy Steels	41(L)30, 41(L)40, 41(L)50
Preheat Treated Steels	4140, 4150
Stainless Steels	17-4PH, 303, 304
Cast Iron	Grade 25, Grade 30
Brass	Free Cutting, Half Hard
Bronze	
Non-Metallic	Phenolic (NEMA "C"), Delron, Nylon

Custom Gearing “Request For Quotation” Form

Company Name _____
 Address _____
 City/State _____ Zip _____
 Tel. No. _____ Fax No. _____
 Contact Name _____
 email _____

Date _____
 Ref. _____
 Quantity Req. _____
 P.O. No. _____



	Gear Type					
						
	Spur	Helical	Miter	Bevel	Worm	Worm Gear
No. of Teeth						
Pitch (DP, CP MOD)						
Pressure Angle						
Helix Angle						
Hand (LH, RH)						
Material						
Face Width						
Length Through Bore						
Hub Diameter						
Hub Projection						
Bore Diameter						
Keyway						
Setscrew(s)						
Teeth in Mating Gear						
Center Distance						
Mounting Distance						
No. of Starts (Thread)						
Outside Diameter						
Heat Treat — Yes/No						
Depth of Hardness						

Special Information _____





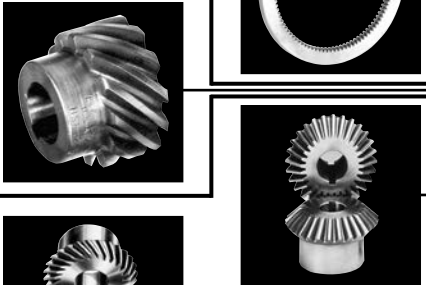
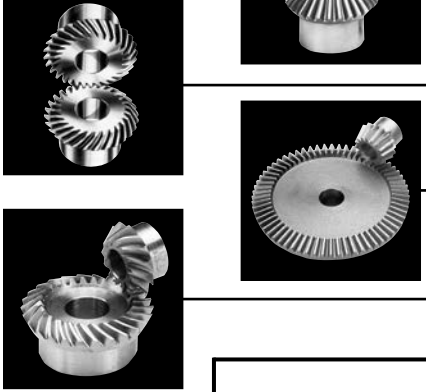





















FAX to 800-387-0130. Or give us a call at 800-816-5608.

Gear Selection













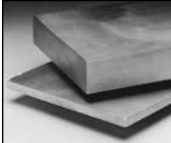



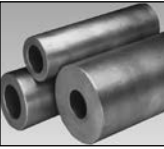



Stock Gears		Description	Application	Pressure Angle (PA)	Material				
Spur Gears		Pinions and Gears	Parallel Shafts	14-1/2° 20° 14-1/2° 20°	Brass Brass Steel Delrin				
		Pinions and Gears	Parallel Shafts	14-1/2° 14-1/2° 20°	Non-Metallic Steel, Iron Steel, Iron				
		Change Gears	Parallel Shafts	14-1/2°	Steel, Iron				
		Stem Pinions	Parallel Shafts	14-1/2°	Steel				
		Drawn Pinion Wire	Parallel Shafts	Brass 14-1/2°	Steel				
		Rack	Use with Spur Gears	14-1/2° 14-1/2° 20°	Nylon Steel Steel				
		Internal Gears	Parallel Shafts	14-1/2° 20°	Brass Brass				
Helical Gears		Helical Gears	Parallel and 90° Non-Intersecting Shafts	14-1/2°	Steel Bronze				
		Straight Miter Gears	90° Intersecting Shafts	20°	Nylon Brass Steel Iron				
		Spiral Miter Gears	90° Intersecting Shafts	20°	Steel				
Miter and Bevel Gears		Straight Bevel Gears	90° Intersecting Shafts	20°	Brass Steel Iron				
		Spiral Bevel Gears	90° Intersecting Shafts	20°	Steel				
		Worms and Worm Gears		Worms/ Worm Gears	90° Non-Intersecting Shafts	(PA) 14-1/2°	Thread Single	Worm Acetal Nylon	Gear Acetal Minlon Bronze
				Worms/ Worm Gears	90° Non-Intersecting Shafts	14-1/2° 20° 25°	Single Double Quad	Steel	Bronze
Worms/ Worm Gears	90° Non-Intersecting Shafts			14-1/2° 20° 25°	Single Double Quad	Steel	Iron		

Reference Guide





















Diametrical Pitch	Pitch Diameter	Face Width		Gear Catalog Reference Pages		
				Selection Procedure	Horsepower and Torque Ratings	Catalog Number Selection
48DP - 16DP 64DP - 24DP 32DP - 24DP 48DP - 24DP	.208" - 5.000" .250" - 6.000" .500" - 6.000" .375" - 2.500"	.062" - .313" .125" - .250" .187" - .250" .125" - .250"		49 49 49 49	50 - 52 - 50 -	18 - 21 37 - 42 19 - 20 37 - 42
16DP - 8DP 20DP - 3DP 20DP - 5DP	1.000" - 3.500" .750" - 36.000" .600" - 36.000"	.500" - 1.250" .500" - 3.000" .500" - 2.500"		49 49 49	52 - 55 51 - 57 58 - 62	22 - 24 20 - 27 42 - 46
20DP - 8DP	1.000" - 12.500"	.375" - 1.250"		49	51 - 55	28 - 32
20DP - 6DP	.287" - 1.750"	1.125" - 3.000"		49	51 - 56	33
48DP - 24DP 48DP - 24DP	.125" - .667" .125" - .667"	48" Lengths 48" Lengths		49 49	50 50	34 34
48DP - 24DP 48DP - 3DP 20DP - 4DP	.104" - .208" .104" - 1.167" .450" - 1.750"	.125" - .250" .125" - 3.000" .500" - 3.500"		49 49 49	50 50 - 57 58 - 62	35 35 47
48DP - 16DP 64DP - 24DP	1.000" - 6.000" 1.000" - 6.000"	.125" - .312" .125" - .250"		49 49	50 -	36 48
24TDP - 6TDP 8TDP - 6TDP	.333" - 6.000" 1.000" - 6.000"	.250" - 1.250" .750" - 1.250"		66 66	67 - 68 68	64 - 65 65
48DP - 16DP 48DP - 24DP 48DP - 4DP 8DP - 4DP	.312" - 2.000" .312" - 1.500" .375" - 7.000" 3.500" - 8.000"	.070" - .390" .080" - .230" .080" - 1.430" .750" - 1.333"		79 79 79 79	80 80 80 - 81 80 - 81	70 - 71 70 70 - 72 72
18DP - 5DP	1.000" - 5.000"	.220" - 1.150"		79	83	73
48DP - 24DP 20DP - 6DP 16DP - 4DP	.250" - 2.000" .500" - 6.000" 1.000" - 9.000"	.090" - .260" .180" - 1.070" .420" - 1.400"		79 79 79	82 82 82	74 74 - 77 75 - 77
30DP - 8DP	.430" - 4.250"	.140" - .710"		79	83	78
48DP - 32DP 24DP 48DP - 24DP	.333" to 1.500"	Worm	Gear	96	-	86 - 88
		.562" to .812"	.156" to .219"			
48DP - 4DP	.333" to 3.000"	.417" to 6.000"	.562" to 5.250"	96	97 - 98	86 - 94
16DP - 3DP	.625" to 4.000"	1.250" to 18.000"	1.000" to 5.250"	96	97 - 98	89 - 95

Tooth Gauge	
20° P.A.	14 1/2° P.A.
 64 D.P.	
 48 D.P.	 48 D.P.
 32 D.P.	 32 D.P.
 24 D.P.	 24 D.P.
 20 D.P.	 20 D.P.
 16 D.P.	 16 D.P.
 12 D.P.	 12 D.P.
 10 D.P.	 10 D.P.
 8 D.P.	 8 D.P.
 6 D.P.	 6 D.P.
 5 D.P.	 5 D.P.
 4 D.P.	 4 D.P.
Tooth Gauge Chart is for Reference Purposes Only.	 3 D.P.



















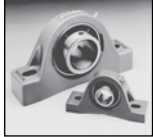

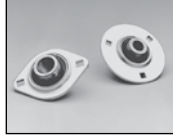
Product Selection / Reference Guide

BOST-BRONZ® OIL IMPREGNATED SINTERED BRONZE	PLAIN CYLINDRICAL  Pages 138–140	FLANGED TYPE  Pages 141–142	THRUST TYPE  Page 143
	PLATE STOCK  Page 143	CORED BARS  Page 144	SOLID BARS  Page 144
BEAR-N-BRONZ® 660 CAST BRONZE	PLAIN CYLINDRICAL  Pages 146–150	CORED BARS  Pages 151–153	SOLID BARS  Page 153
BRONZE EMERGENCY BEARING BANKS	BOST-BRONZ & BEAR-N-BRONZ  Page 154	BOSTONE® F-1 GLASS FILLED TEFLON	
BOSTonE® F-1 GLASS FILLED TEFLON	FLANGED  Page 156	THRUST TYPE  Page 157	PLAIN CYLINDRICAL  Page 156
Rulon®	RULON® 641 BEARINGS  Pages 158–159	BOSTONE® MOLDED PLASTIC	
BOSTonE® MOLDED PLASTIC	PLAIN CYLINDRICAL  Page 161	FLANGED  Page 161	
	ROLL END FOR TUBING & STANDARD PIPE  Pages 162–168	EXTRA LENGTH BLIND BORE INSERTS  Page 169	ROLL END ADAPTER FOR HEX SHAFT  Page 169
ROLLERS  Page 170	SHAFT CLIP  Page 171	STUB SHAFT FOR ROLLERS  Page 171	

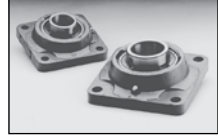

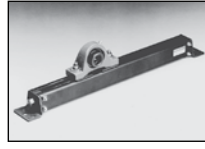















Product Selection / Reference Guide

BOSStonE® MOLDED NYLON	PLAIN CYLINDRICAL  Page 172	FLANGED  Page 172	THRUST TYPE  Page 173	CABLE PULLEYS  Page 173
	1600 SERIES  Pages 185–186	7500 SERIES  Page 187	7600 SERIES  Page 188	6900 SERIES  Page 189
RADIAL BALL BEARINGS	3000 SERIES  Pages 190–191	400F SERIES FLANGED  Page 192		
	GROUND, UNBANDED  Page 193	600 SERIES  Page 194		
THRUST BALL BEARINGS	2000 SERIES  Page 195	2100 SERIES  Page 196	BALL BEARING WHEELS	2200 SERIES  Page 197
	KF FEMALE SERIES  Page 198	HM-C SERIES HF-C FEMALE SERIES  Page 199		CMHD MALE SERIES CFHD FEMALE SERIES  Page 200
ROD END BEARINGS	HME MALE SERIES HFE FEMALE SERIES  Page 202	HMX MALE SERIES HFX FEMALE SERIES  Page 203		











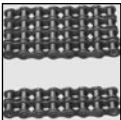

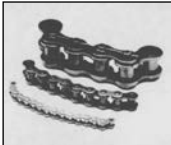



Product Selection / Reference Guide

SPHERICAL BEARINGS	LHA-LHB-LHSS SERIES  Page 204	LHSSE-LHSSV SERIES  Page 205	LS SERIES  Page 206	
	REPLACEMENT BEARINGS & LOCKING COLLAR SERIES	L, H, F, T, A SERIES  Page 213	PS/XL-S-MB SERIES  Page 214	
PILLOW BLOCKS	PPB SERIES  Page 215	PS SERIES  Page 216	XL SERIES  Page 217	L SERIES H SERIES  Pages 218-219
	SL/SH SERIES  Pages 220-221	MB SERIES  Page 222		
FLANGED UNITS	PS2/PS3 SERIES  Page 223	XL2/XL3 SERIES  Page 224	F SERIES T SERIES  Pages 225-226	SF/ST SERIES  Pages 227-228
	MBF SERIES  Page 229	MBP SERIES  Page 230		
SHAFT SUPPORTS	A SERIES  Page 231	TAKE-UP FRAMES	TU SERIES  Page 232	
STAINLESS STEEL MOUNTED BEARINGS	SSUP/SSHC SERIES  Pages 233-234	SSUFL/SSUF SERIES  Pages 235-236	SSUFB SERIES  Page 237	SSUT SERIES  Page 238

Product Selection / Reference Guide

COUPLINGS	<p>INSERT (3 JAW)</p>  <p>FC Type – Pages 100-101</p>	<p>SPIDER RING</p>  <p>BF Type – Page 102</p>	<p>SHEAR</p>  <p>BG Type – Page 103</p>	
	<p>CLAMP</p>  <p>SCC Type – Page 104</p>	<p>MULTI-JAW</p>  <p>FA Type – Page 105</p>	<p>RIGID</p>  <p>CR Type – Page 105</p>	<p>SLEEVE</p>  <p>FCP Type – Page 106</p>
UNIVERSAL JOINTS	<p>PIN & BLOCK</p>  <p>J Type – Pages 107-108</p>	<p>FORGED</p>  <p>UJN Type – Pages 109-111</p>	<p>MOLDED</p>  <p>JP Type – Page 112</p>	<p>MOLDED WITH SLIDE EXTENSION</p>  <p>JPE Type – Page 113</p>
	COLLARS	<p>SETSCREW</p>  <p>SC Type – Page 114</p>	<p>CLAMPING-THREADED</p>  <p>CSC Type – Page 115</p>	<p>CLAMPING – 1 PIECE</p>  <p>CS Type – Page 116</p>
WASHERS		<p>HARDENED STEEL WASHERS</p>  <p>Page 118</p>	<p>BUSHINGS</p>	
	PULLEYS	<p>GROOVED</p>  <p>Page 120</p>		
MINIATURE TIMING BELTS & PULLEYS		<p>TIMING BELTS</p>  <p>Pages 121-124 & 130</p>	<p>PULLEYS</p>  <p>Pages 125-129 & 131-134</p>	

Product Selection / Reference Guide

ROLLER, BLOCK & LEAF CHAINS	<p>MULTIPLE WIDTHS ANSI STANDARD</p>  <p>Page 251-252</p>	<p>TRANSMISSION SERIES</p>  <p>Page 253</p>	<p>CONVEYOR SERIES</p>  <p>Page 253</p>	<p>HEAVY SERIES</p>  <p>Page 253</p>	
	<p>ATTACHMENTS</p>  <p>Page 259</p>	<p>HOLLOW PIN</p>  <p>Page 260</p>	<p>BLOCK</p>  <p>Page 261</p>	<p>LEAF (CABLE)</p>  <p>Page 261</p>	
	<p>LADDER</p>  <p>Page 262</p>	<p>MINIATURE ROLLER CHAIN</p>  <p>Page 263</p>	<p>CHAIN PULLERS & CHAIN BREAKING TOOLS</p>  <p>Page 264</p>		
	SPROCKETS	<p>PLASTIC & STAINLESS STEEL</p>  <p>Page 274</p>	<p>ROLLER CHAIN</p>  <p>Pages 275-297</p>	<p>BLOCK CHAIN</p>  <p>Page 298</p>	<p>LADDER CHAIN</p>  <p>Pages 299-300</p>
		SCREW/SPRING ADJUSTABLE SHAFT MOUNTED DRIVE TENSIONS			
		DRIVE TENSIONERS	<p>TYPE LG</p>  <p>Page 301</p>	<p>TYPE BG</p>  <p>Pages 301-303</p>	<p>TYPE HG &UG</p>  <p>Page 304</p>

- Parallel Shaft Applications
- Reliability from Steel, Cast Iron and Brass
- More Cost Effective, Quieter Running and Corrosion-Resistant Operation from Non-Metallic Options
- Higher Load Carrying Capacity with 20° PA (Pressure Angle)
- Higher Contact Ratio for a Smoother, Quieter Operation with 14-1/2° PA

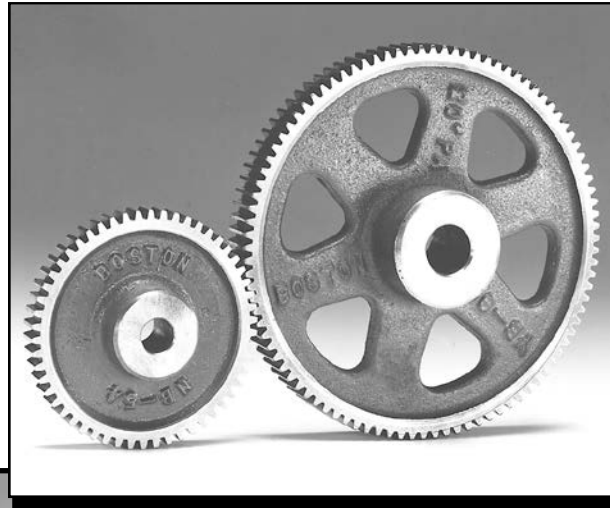

Selections From Stock

- Pinions and Gears (Steel, Cast Iron, Brass, Non-Metallic)
- Change Gears (Steel or Cast Iron)
- Stem Pinions (Steel)
- Drawn Pinion Wire (Brass, Steel)
- Rack (Steel, Nylon)
- Internal (Brass)
- Diametral Pitch 64 DP to 3 DP
- Pitch Diameter .208" to 36.000"
- Diametral Pitch System Standardized on Stock Gears
- 14-1/2° and 20° Pressure Angles

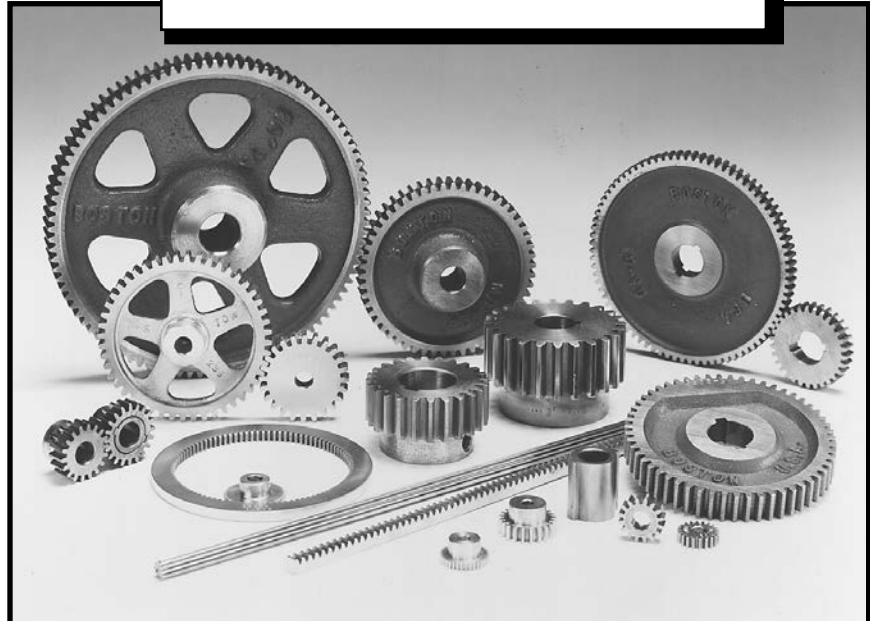

Boston spur gears are designed to transmit motion and power between parallel shafts. Configurations include spur, rack, pinion wire, stem pinions and internal gears; most with a selection of bores, keyways and set screws. Fine-pitch gears are available in plastic, brass, stainless steel and steel. Heavier pitch spurs are available in steel and cast iron. Styles include plain, web, web with lightening holes or spoked. Change gears have consecutive numbers of teeth for a variety of ratios.

Boston Gear manufactures both 14-1/2° and 20°PA, involute, full depth system gears. While 20°PA is generally recognized as having higher load carrying capacity, 14-1/2°PA gears have extensive use. The lower Pressure Angle results in less change in backlash due to center distance variation and concentricity errors. It also provides a higher contact ratio and is consequently a smoother, quieter operation provided that the undercut of the teeth is not present.

Helical Gears

- Parallel and 90° Non-Intersecting Shaft Applications
- Improved Tooth Strength
- Greater Load Carrying Capacity
- Increased Contact Ratio
- Smoother Operating Characteristics

Selections From Stock

- Helicals, 45° Helix Angle
- Transverse Diametral Pitch (TDP) System
- Hardened Steel (24 TDP – 6 TDP)
- Bronze (8 TDP – 6 TDP)
- Pitch Diameter .333" to 6.000"
- 14-1/2° Pressure Angle

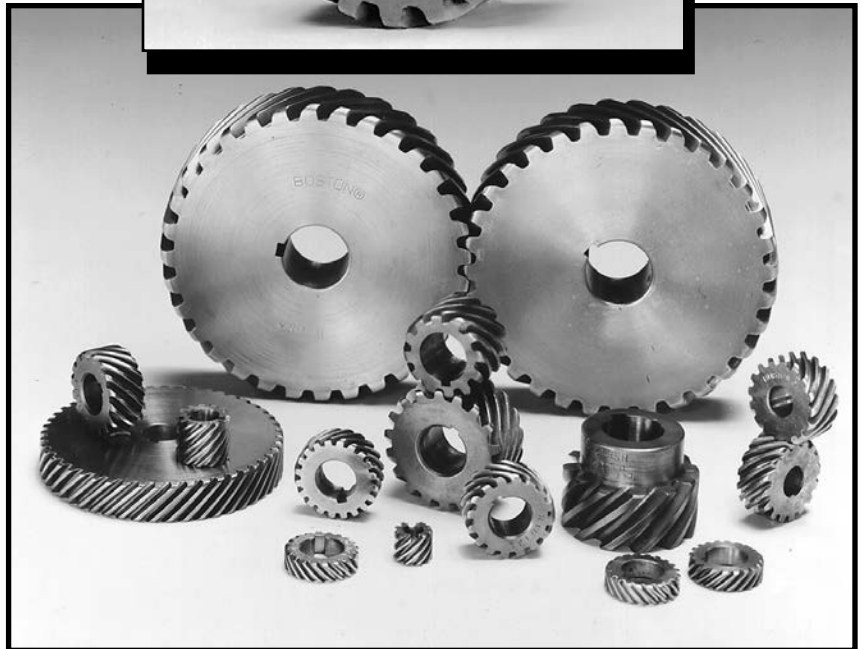

Boston helical gears are stocked both right and left hand, made with a 45° helix angle. They are designed to transmit motion and power between non-intersecting shafts which are positioned either parallel (opposing hand) or at 90° to each other (same hand). Because these gears are top-hobbed, there is extremely close concentricity between the pitch diameter and the outside diameter.

Helical gears offer additional benefits relative to Spur Gears, those being:

- *Improved tooth strength due to the elongated helical wrap-around.*
- *Increased contact ratio due to the axial tooth overlap.*
- *Helical Gears tend to have greater load carrying capacity than Spur Gears of similar size.*
- *Because of the above, smoother operating characteristics are apparent.*

All Boston Helicals are cut to the Transverse Diametral Pitch System, resulting in a higher Normal Diametral Pitch Number.

Miter and Bevel Gears

- 90° Intersecting Shaft Applications
- Coniflex® Tooth Form for Increased Life and Smoother, Quieter Operation
- Spiral Miter and Bevel for Higher Speed, Greater Torque Load, and Quieter Operating Applications
- Miter Gears for 1:1 Ratio Applications
- Bevel Gears for 1.5:1 to 6:1 Ratio Applications
- Soft Bores for Customized Alterations

Selections from Stock

- Straight Miter Gears
 - Nylon (48 DP – 16 DP)
 - Brass (48 DP – 24 DP)
 - Steel (48 DP – 4 DP)
 - Iron (8 DP – 4 DP)
- Spiral Miter Gears (35° Spiral Angle)
 - Steel (18 DP – 5 DP)
- Straight Bevel Gears
 - Brass (48 DP – 24 DP)
 - Steel (20 DP – 6 DP)
 - Iron (16 DP – 4 DP)
- Spiral Bevel Gears (35° Spiral Angle)
 - Steel (30 DP – 8 DP)
- Diametral Pitch – 48 DP to 4 DP
- Pitch Diameter – 0.250” to 9.000”
- 20° Pressure Angle
- Hardened or Unhardened Teeth (Steel)
- Made in Accordance with AGMA Specifications for the Basic Tooth Form



Boston miter and bevel gears are designed for transmission of motion and power between intersecting shafts positioned at a right angle. Straight tooth miter and bevel gears are cut with a generated tooth form having a localized lengthwise tooth bearings known as the “Coniflex”® tooth form. The superiority of these gears over straight bevels with full length tooth bearing lies in the control of tooth contact. The localization of contact permits minor adjustment of the gears in assembly and allows for some displacement due to deflection under operating loads, without concentration of the load on the end of the tooth. This results in increased life and quieter operation.

Spiral tooth form miter and bevel gears are suited for higher speed and larger torque applications.

®Registered trademark of The Gleason Works.



WARNING: Cancer and Reproductive Harm – www.P65Warnings.ca.gov

Boston Gear

Worms and Worm Gears

- 90° Non-Intersecting Shaft Applications
- Smoothest, Quietest Form of Gearing
- High Ratio Speed Reduction
- Minimal Space Requirements
- Resistance to Back Driving with Some Ratios
- Increased Efficiency with Lower Ratios

Selections from Stock

- Worms
 - Acetal (48 DP – 24 DP)
 - Steel (48 DP – 3 DP)
- Worm Gears
 - Acetal (48 DP – 24 DP)
 - Bronze (48 DP – 4 DP)
 - Cast Iron (16 DP – 3 DP)
- Pressure Angle
 - 14-1/2°, 20°, 25°
- Thread
 - Single, Double, Quadruple
- Diametral Pitch – 48 DP to 3 DP
- Center Distances – 0.375" to 11.000"

⚠ California Proposition 65 Warning:

The Bronze worm gearing contains lead, a chemical known to the state of California to cause cancer, birth defects or other reproductive harm.

Boston Gear worms and worm gears provide an effective answer for such power transmission applications as high-ratio speed reduction, limited space, right-angle shafts and non-intersecting shafts. When properly applied, they are the smoothest and quietest form of gearing. Steel worms and cast iron or bronze worm gears having throated teeth are available in single or multiple threads, 48 to 3 diametral pitch or up to 85" pitch diameter. Acetal worms and worm gears are available in 48, 32 and 24 diametral pitches.

The efficiency of a worm gear drive depends on the lead angle and number of starts on the worm. The angle generally decreases with increasing ratio and worm pitch diameter. For increased efficiency the ratio should be kept low.

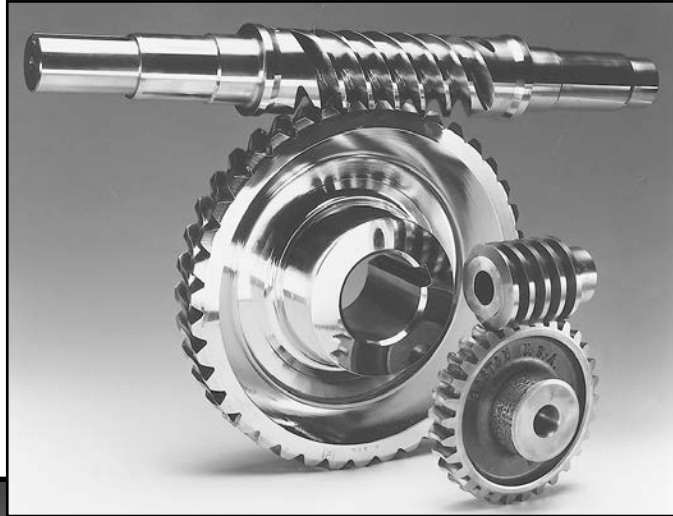

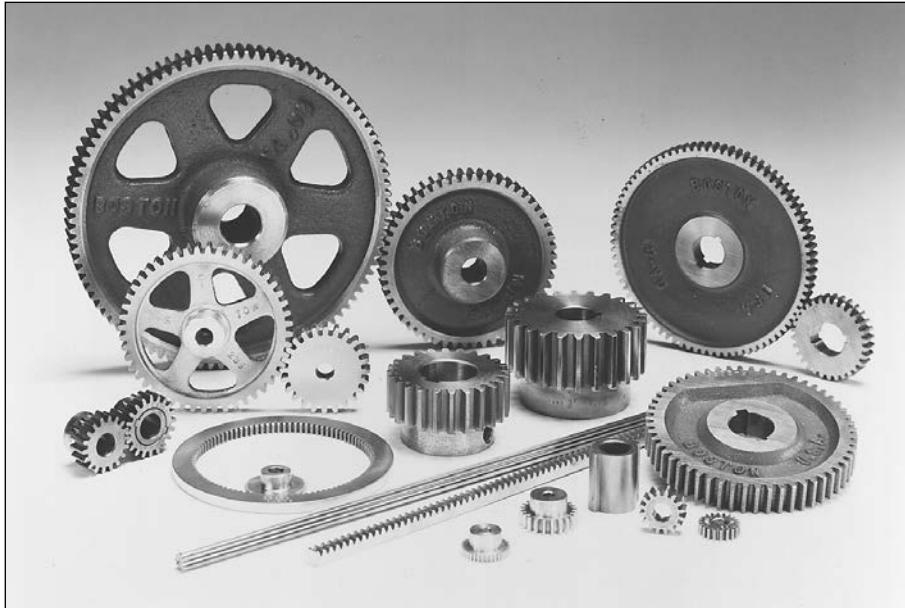

14-1/2° PRESSURE ANGLE – CATALOG NUMBER / DIMENSIONS

Spur Gears.....	18-27
Change Gears	28-32
Stem Pinions	33
Drawn Pinion Wire.....	34
Rack.....	35
Internal Gears.....	36

20° PRESSURE ANGLE – CATALOG NUMBER / DIMENSIONS

Spur Gears.....	37-46
Rack.....	47
Internal Gears.....	48

Selection Procedure.....	49
Horsepower & Torque Ratings	50-62
Gear Gauges	62
Stock Altered/Custom Spur Gears.....	3-5
Spur Gear Engineering Information.....	306-311

Spur Gears

48 and 32 Diametral Pitch (Brass)

14-1/2° Pressure Angle (will not operate with 20° spurs)

A

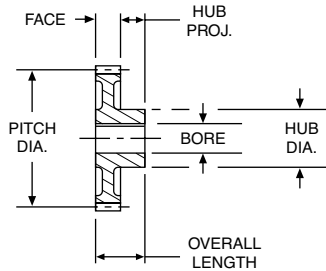

STANDARD TOLERANCES

DIMENSION		TOLERANCE
BORE	All	±.0005



REFERENCE PAGES

Alterations — 322
Lubrication — 322
Materials — 323

ALL DIMENSIONS IN INCHES
ORDER BY CATALOG NUMBER OR ITEM CODE

No. of Teeth	Pitch Dia.	Bore	Hub		Style See Page 323	Without Keyway or Setscrew	
			Dia.	Proj.		Catalog Number	Item Code
48 DIAMETRAL PITCH						Face = .125" Outside Dia. = Pitch Dia. + .042" Overall Length = .125" + Hub Proj.	
BRASS							
10	.208	.0935	-	-	A	G127	09322
12	.250	.125	-	-		G129	09324
14	.292					G130	09326
15	.312					G131	09328
16	.333					G132	09330
18	.375					G133	09332
20	.417					G134	09334
22	.458	.1875	-	-		G135	09336
24	.500					G136	09338
26	.542					G137	09340
32	.667				G138	09342	
36	.750				G139	09344	
40	.833				G140	09346	
44	.917	.250	.50	.25	G141	09348	
48	1.000				G142	09350	
54	1.125				G143	09352	
60	1.250				G144	09354	
66	1.375				G145	09356	
72	1.500				G146	09358	
84	1.750	.3125	.62	.31	G147	09360	
96	2.000				G148	09362	
100	2.083				G154	09364	
120	2.500				G149	09366	
144	3.000				G150	09368	
192	4.000				G151	09370	
32 DIAMETRAL PITCH						Face = .062" Outside Dia. = Pitch Dia. + .062"	
BRASS							
10	.312	.125	-	-	A	G96	09234
14	.438					G98	09238
16	.500	.1875	-	-		G99	09240
20	.625					G101	09244
24	.750					G102	09246
28	.875					G103	09248
32	1.000					G104	09250
40	1.250					.250	-
48	1.500	G106	09254				
64	2.000	.3125	-	-		G110	09256
80	2.500				G111	09258	
96	3.000				G112	09260	
112	3.500				G113	09262	
128	4.000				G114	09264	
Face = .188"							
8	.250	.125	-	-	A	G159	09266
10	.312					G161	09268
12	.375					G163	09270
14	.438					G165	09272
15	.469					G166	09274
16	.500	.1875	-	-		G167	09276
18	.562					G168	09278
20	.625					G169	09280
22	.688					G170	09282
24	.750					G171	09284
26	.812				G172	09286	
28	.875				G173	09288	
30	.938				G174	09290	
32	1.000	.250	-	-	G175	09292	
36	1.125				G176	09294	
40	1.250				G177	09296	
44	1.375				G178	09298	
48	1.500				G179	09300	
52	1.625				G180	09302	
56	1.750	.3125	-	-	G181	09304	

32 and 24 Diametral Pitch (Brass & Steel) 14-1/2° Pressure Angle (will not operate with 20° spurs)

ALL DIMENSIONS IN INCHES
ORDER BY CATALOG NUMBER OR ITEM CODE

No. of Teeth	Pitch Dia.	Bore	Hub		Style See Page 323	Without Keyway or Setscrew		With Setscrew	
			Dia.	Proj.		Catalog Number	Item Code	Catalog Number	Item Code
32 DIAMETRAL PITCH						Face = .188" Outside Dia. = Pitch Dia. + .062" Overall Length = .187" + Hub Proj.			
BRASS									
64	2.000	.3125	.62	.25	B	G182	09306	-	-
72	2.250			C	G183	09308	-	-	
80	2.500			.31	D	G184	09310	-	-
96	3.000				G185	09312	-	-	
112	3.500				G186	09314	-	-	
128	4.000				.75	G187	09316	-	-
STEEL									
16	.500	.1875	-	-	A	S3216	09572	-	-
20	.625	.250	-	-		S3220	09574	-	-
22	.688	.3125	-	-		S3222	09576	-	-
24	.750		-	-		S3224	09578	-	-
28	.875	.375	-	-		S3228	09580	-	-
32	1.000	.375	-	-		S3232	09582	-	-
40	1.250	.375	-	-		S3240	09584	-	-
48	1.500		-	-		S3248	09586	-	-
56	1.750		-	-		S3256	09588	-	-
64	2.000		-	-		S3264	09590	-	-
80	2.500		-	-		S3280	09592	-	-
96	3.000		-	-		S3296	09594	-	-
16	.500	.1875	.39	.31	-	-	H3216	09536	
18	.562	.250	.45	.31	-	-	H3218	09538	
20	.625	.3125	.52	.31	-	-	H3220	09540	
22	.688	.375	.58	.31	-	-	H3222	09542	
24	.750	.450	.64	.31	-	-	H3224	09544	
26	.812	.500	.70	.31	-	-	H3226	09546	
28	.875	.550	.75	.31	-	-	H3228	09548	
30	.938	.600	.75	.38	-	-	H3230	09550	
32	1.000	.650	.75	.38	-	-	H3232	09552	
40	1.250	.750	.88	.38	-	-	H3240	09554	
48	1.500	.850	.88	.38	-	-	H3248	09556	
56	1.750	1.000	1.00	.38	-	-	H3256	09558	
64	2.000	1.100	1.00	.38	-	-	H3264	09560	
80	2.500	1.250	1.12	.38	-	-	H3280	09562	
96	3.000	1.400	1.25	.50	-	-	H3296	09564	
128	4.000	1.750	1.88	.50	-	-	H32128	09566	
160	5.000	2.250	2.12	.50	-	-	H32160	09568	
192	6.000	2.750	2.12	.50	-	-	H32192	09570	
24 DIAMETRAL PITCH						Face = .250" Outside Dia. = Pitch Dia. + .083" Overall Length = .250" + Hub Proj.			
BRASS									
12	.500	.1875	.38	.25	A	G254	09202	-	-
16	.667		.50	.25		G256	09204	-	-
18	.750		.50	.25		G257	09206	-	-
24	1.000	.250	.62	.25	G258	09208	-	-	
30	1.250		.62	.25	G259	09210	-	-	
36	1.500		.62	.25	G261	09212	-	-	
42	1.750		.62	.25	G263	09214	-	-	
48	2.000	.3125	.62	.25	B	G264	09216	-	-
54	2.250		.69	.31		G265	09218	-	-
60	2.500		.69	.31	C	G266	09220	-	-
66	2.750		.69	.31		G267	09222	-	-
72	3.000	.375	.75	.31	D	G268	09224	-	-
84	3.500		.75	.31		G269	09226	-	-
96	4.000		.75	.31		G270	09228	-	-
120	5.000		.88	.38		G272	09230	-	-
144	6.000		.88	.38		G274	09232	-	-

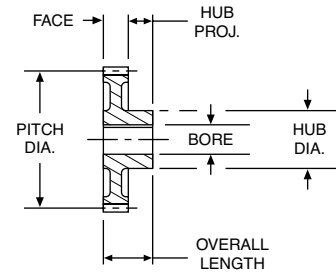

STANDARD TOLERANCES

DIMENSION	TOLERANCE
BORE	All ±.0005



REFERENCE PAGES

- Alterations — 322
- Horsepower Ratings — 50
- Lubrication — 322
- Materials — 323
- Selection Procedure — 49

Spur Gears

24 and 20 Diametral Pitch (Steel)

14-1/2° Pressure Angle (will not operate with 20° spurs)

A

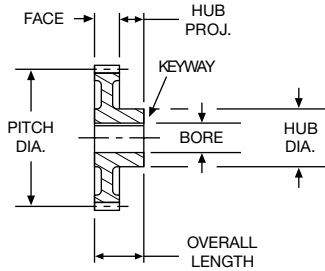

STANDARD TOLERANCES

DIMENSION		TOLERANCE
BORE	All	±.0005



REFERENCE PAGES

- Alterations — 322
- Horsepower Ratings — 50, 51
- Lubrication — 322
- Materials — 323
- Selection Procedure — 49

*Special Pitch Diameter, used for calculating Center Distance only, not Ratio.

†H2412 & H2414 have #35 (.110) drilled hole through one wall, no keyway.

‡H2415-H24144 has one setscrew, no keyway.

**NA11B-5/16"-NA14B-5/16 bore has #35 (.110) drilled hole through one wall, no keyway.

††3/8" & 1/2" bores have one setscrew, no keyway.

NA40-5/8" & NA40-3/4" bores have standard keyway at 90° to setscrew. See Page 323.

ALL DIMENSIONS IN INCHES
ORDER BY CATALOG NUMBER OR ITEM CODE

No. of Teeth	Pitch Dia.	Bore	Hub		Style See Page 323	Without Keyway or Setscrew		With Keyway & Setscrew†	
			Dia.	Proj.		Catalog Number	Item Code	Catalog Number	Item Code
24 DIAMETRAL PITCH						Face = .250" Outside Dia. = Pitch Dia. + .083" Overall Length = .250" + Hub Proj.			
STEEL									
12	.500	.250	-	-	A	S2412	09630	-	-
15	.625		-	-		S2415	09632	-	-
16	.667		-	-		S2416	09634	-	-
18	.750		-	-		S2418	09636	-	-
21	.875	.500	-	-	S2421	09638	-	-	
24	1.000		-	-	S2424	09640	-	-	
30	1.250		-	-	S2430	09642	-	-	
36	1.500		-	-	S2436	09644	-	-	
42	1.750		-	-	S2442	09646	-	-	
48	2.000		-	-	S2448	09648	-	-	
60	2.500		-	-	S2460	09650	-	-	
72	3.000		-	-	S2472	09652	-	-	
12	.500	.250	.36	.31	-	-	H2412†	09596	
14	.583		.46		H2414†	09598			
15	.625		.50		H2415‡	09600			
16	.667		.54		H2416‡	09602			
18	.750	.3125	.62	.31	-	-	H2418‡	09604	
20	.833		.70		H2420‡	09606			
21	.875		.74		H2421‡	09608			
24	1.000		.87		H2424‡	09610			
30	1.250		1.00		H2430‡	09612			
36	1.500		1.12		H2436‡	09614			
42	1.750		1.12		H2442‡	09616			
48	2.000		1.25		H2448‡	09618			
60	2.500	1.25	H2460‡	09620					
72	3.000	.500	1.38	.50	-	-	H2472‡	09622	
96	4.000		2.00		H2496‡	09624			
120	5.000		2.25		H24120‡	09626			
144	6.000		2.25		H24144‡	09628			
20 DIAMETRAL PITCH						Face = .375" Outside Dia. = Pitch Dia. + .100" Overall Length = .375" + Hub Proj.			
STEEL									
11	.600*	.3125	.46	.38	NA11B	09662	NA11B-5/16**	46000	
12	.600		.46		NA12B	09664	NA12B-5/16**	46001	
13	.650		.50		NA13B	09666	NA13B-5/16**	46002	
14	.700		.56		NA14B	09668	NA14B-5/16**	46003	
15	.750	.375	.60	.38	NA15B	09670	NA15B-3/8††	46004	
16	.800		.66		NA16B	09672	NA16B-3/8††	46005	
18	.900		.74		NA18B	09674	NA18B-3/8††	46006	
20	1.000		.84		NA20B	09676	NA20B-3/8††	46007	
		.500	.82	.38	-	-	NA20B-1/2††	46008	
22	1.100		.82		NA22B	09678	NA22B-3/8††	46009	
			.92		-	-	NA22B-1/2††	46010	
24	1.200		.92		NA24	09680	NA24-3/8††	46011	
		.375	.97	.38	-	-	NA24-1/2††	46012	
25	1.250		.97		NA25B	09682	NA25B-3/8††	46013	
			1.12		-	-	NA25B-1/2††	46014	
28	1.400		1.12		NA28B	09684	NA28B-3/8††	46015	
		.500	1.22	.38	-	-	NA28B-1/2††	46016	
30	1.500		1.22		NA30B	09686	NA30B-3/8††	46017	
			1.32		-	-	NA30B-1/2††	46018	
32	1.600		1.32		NA32	09688	NA32-3/8††	46019	
		.375	1.47	.50	-	-	NA32-1/2††	46020	
35	1.750		1.47		NA35	09690	NA35-3/8††	46021	
			1.52		-	-	NA35-1/2††	46022	
36	1.800		1.52		NA36	09692	NA36-3/8††	46023	
		.500	1.72	.50	-	-	NA36-1/2††	46024	
40	2.000		1.72		NA40	09694	NA40-3/8††	46025	
			1.33		-	-	NA40-1/2††	46026	
48	2.400		1.33		-	-	NA40-5/8	46027	
50	2.500	.375	1.42	.50	-	-	NA40-3/4	46028	
60	3.000		1.92		NA48A	10208	-	-	
64	3.200		2.12		NA50A	10210	-	-	
					NA60A	10212	-	-	
			NA64A	10214	-	-			

20 and 16 Diametral Pitch (Cast Iron, Brass & Steel)

14-1/2° Pressure Angle (will not operate with 20° spurs)

ALL DIMENSIONS IN INCHES
ORDER BY CATALOG NUMBER OR ITEM CODE

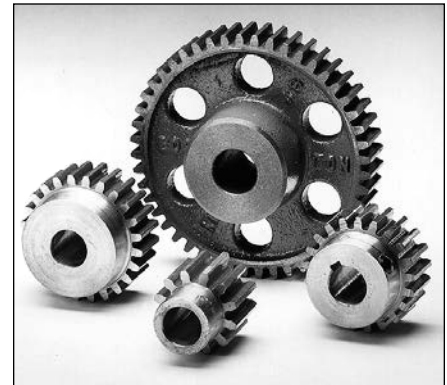

A

No. of Teeth	Pitch Dia.	Bore	Hub		Style See Page 323	Without Keyway or Setscrew		With Keyway and Setscrew†					
			Dia.	Proj.		Catalog Number	Item Code	Catalog Number	Item Code				
20 DIAMETRAL PITCH						Face = .375" Outside Dia. = Pitch Dia. + .100" Overall Length = .375" + Hub Proj.							
CAST IRON													
70	3.500	.375	1.25	.50	B	NA70	10216	-	-				
72	3.600					NA72	10218	-	-				
80	4.000					NA80	10220	-	-				
84	4.200					NA84	10222	-	-				
90	4.500	.500	1.25	.50	C	NA90	10224	-	-				
96	4.800					NA96	10226	-	-				
100	5.000					NA100	10228	-	-				
112	5.600					NA112	10230	-	-				
120	6.000	.500	1.50	.50	D	NA120	10232	-	-				
140	7.000					NA140	10234	-	-				
144	7.200					NA144	10236	-	-				
160	8.000					NA160	10238	-	-				
180	9.000					NA180	10240	-	-				
200	10.000					NA200B	10242	-	-				
16 DIAMETRAL PITCH						Face = .313" Outside Dia. = Pitch Dia. + .125" Overall Length = Face + Hub Proj.							
BRASS													
8	.500	.1875	-	-	A	G226	09168	-	-				
9	.563					G227	09170	-	-				
10	.625					G228	09172	-	-				
12	.750					G229	09174	-	-				
14	.875	.250	-	-	A	G230	09176	-	-				
16	1.000					G231	09178	-	-				
18	1.125					G232	09180	-	-				
20	1.250					G233	09182	-	-				
24	1.500	.3125	-	-	A	G235	09184	-	-				
28	1.750					G236	09186	-	-				
32	2.000					G237	09188	-	-				
40	2.500					G238	09190	-	-				
48	3.000	.3125	.75	.31	B	G239	09192	-	-				
56	3.500					.375	1.00	.38	D	G240	09194	-	-
64	4.000									G241	09196	-	-
80	5.000									G242	09198	-	-
STEEL Face = .500"													
11	.750*	.375	.56	.44	A	NB11B	09704	NB11B-3/8†	46029				
12	.750					NB12B	09706	NB12B-3/8†	46030				
13	.813					NB13B	09708	NB13B-3/8†	46031				
14	.875					NB14B	09710	NB14B-3/8†	46032				
15	.938	.500	.75	.44	A	NB15B	09712	NB15B-1/2†	46033				
16	1.000					NB16B	09714	NB16B-1/2†	46034				
18	1.125					NB18B	09716	NB18B-1/2†	46035				
20	1.250					NB20B	09718	NB20B-1/2†	46036				
22	1.375	.500	.96	.44	A	-	-	NB20B-5/8	46037				
						NB22B	09720	NB22B-1/2†	46038				
24	1.500	.625	1.08	.44	A	-	-	NB22B-5/8	46039				
						NB24B	09722	NB24B-1/2†	46040				
						-	-	NB24B-5/8	46041				
26	1.625	.750	1.20	.44	A	-	-	NB24B-3/4	46042				
						NB26B	09724	NB26B-1/2†	46043				
						-	-	NB26B-5/8	46044				
28	1.750	.875	1.33	.44	A	-	-	NB26B-3/4	40645				
						NB28B	09726	NB28B-1/2†	46046				
						-	-	NB28B-5/8	46047				
30	1.875	1.000	1.45	.50	A	-	-	NB28B-3/4	46048				
						-	-	NB28B-7/8	46049				
						NB30B	09728	NB30B-1/2†	46050				
						-	-	NB30B-5/8	46051				
30	1.875	1.000	1.58	.50	A	-	-	NB30B-3/4	46052				
						-	-	NB30B-7/8	46053				
						-	-	NB30B-1	46054				

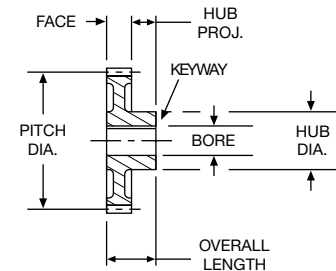

STANDARD TOLERANCES

DIMENSION	TOLERANCE
BORE	All ±.0005



REFERENCE PAGES

- Alterations — 322
- Horsepower Ratings — 51, 52
- Lubrication — 322
- Materials — 323
- Selection Procedure — 49

*Special Pitch Diameter, used for calculating Center Distance only, not Ratio.

†3/8" and 1/2" bores have one setscrew, no keyway.
5/8" bore and larger have standard keyway at 90° to setscrew. See Page 323.

Spur Gears

16 and 12 Diametral Pitch (Steel, Non-Metallic & Cast Iron)

14-1/2° Pressure Angle (will not operate with 20° spurs)

A

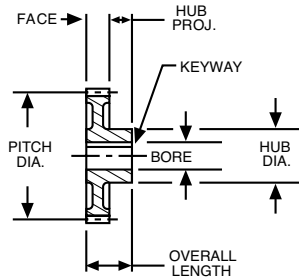
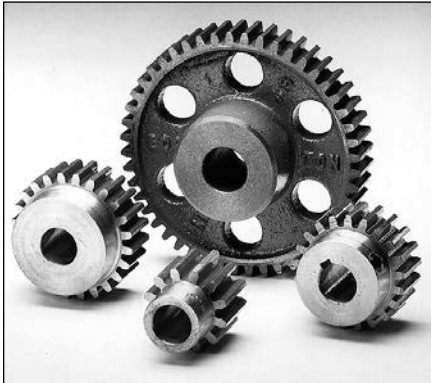

STANDARD TOLERANCES

DIMENSION		TOLERANCE
BORE	All	±.0005



REFERENCE PAGES

- Alterations — 322
- Horsepower Ratings — 52, 53
- Lubrication — 322
- Materials — 323
- Selection Procedure — 49

*Special Pitch Diameter, used for calculating Center Distance only, not Ratio.

†1/2" bore has one setscrew, no keyway.

5/8" bore and larger have standard keyway at 90° to setscrew. See Page 323.

ALL DIMENSIONS IN INCHES
ORDER BY CATALOG NUMBER OR ITEM CODE

No. of Teeth	Pitch Dia.	Bore	Hub		Style See Page 323	Without Keyway or Setscrew		With Keyway and Setscrew†			
			Dia.	Proj.		Catalog Number	Item Code	Catalog Number	Item Code		
16 DIAMETRAL PITCH											
						Face = .500" Outside Dia. = Pitch Dia. + .125" Overall Length = .500" + Hub Proj.					
STEEL											
32	2.000	.500 .625 .750 .875 1.000	1.70	.50	A	NB32	09730	NB32-1/2†	46055		
						-	-	NB32-5/8	46056		
						-	-	NB32-3/4	46057		
						-	-	NB32-7/8	46058		
						-	-	NB32-1	46059		
36	2.250	.500	1.95	.50		NB36	09732	-	-		
40	2.500	.500	1.69			NB40A	10244	-	-		
48	3.000	.500	2.19			NB48A	10246	-	-		
NON-METALLIC											
16	1.000	.375	.81	.50		QBH16	09014	-	-		
20	1.250	.375	1.06			QBH20	09018	-	-		
24	1.500	.500	1.31	.50	A	QBH24	09022	-	-		
32	2.000		1.81			QBH32	09024	-	-		
40	2.500		-			QB40	09000	-	-		
48	3.000		-			QB48	09002	-	-		
64	4.000		-			QB64	09006	-	-		
CAST IRON											
54	3.375	.500	1.25	.50	B	NB54	10248	-	-		
56	3.500		1.25			NB56	10250	-	-		
60	3.750		1.38			NB60	10252	-	-		
64	4.000	.625	1.38	.62	C	NB64	10254	-	-		
72	4.500		1.38			NB72	10256	-	-		
80	5.000		1.50			NB80	10258	-	-		
84	5.250		1.50			NB84	10260	-	-		
96	6.000		1.50			NB96	10262	-	-		
112	7.000		1.50		NB112	10264	-	-			
120	7.500		1.50		NB120	10266	-	-			
128	8.000		1.50		NB128	10268	-	-			
144	9.000		.625		1.75	.75	D	NB144	10270	-	-
160	10.000				1.75			NB160B	10272	-	-
192	12.000	2.00		NB192B	10274			-	-		
12 DIAMETRAL PITCH											
						Face = .750" Outside Dia. = Pitch Dia. + .167" Overall Length = .750" + Hub Proj.					
STEEL											
11	1.000*	.500	.75	.50		ND11B	09744	ND11B-1/2†	46060		
12	1.000		.75			ND12B	09746	ND12B-1/2†	46061		
13	1.083		.83			ND13B	09748	ND13B-1/2†	46062		
14	1.167		.92			ND14B	09750	ND14B-1/2†	46063		
15	1.250	.625	1.00	.50		ND15B	09752	ND15B-5/8	46064		
16	1.333		.99			ND16B	09754	ND16B-5/8	46065		
18	1.500		1.15			ND18B	09756	ND18B-5/8	46066		
20	1.667	.625 .750	1.32	.50		ND20B	09758	ND20B-5/8	46067		
							-	-	ND20B-3/4	46068	
21	1.750	.625 .750 .875	1.40	.50	A	ND21B	09760	ND21B-5/8	46069		
							-	-	ND21B-3/4	46070	
							-	-	ND21B-7/8	46071	
22	1.833	.625 .750 .875 1.000	1.49	.50		ND22B	09762	ND22B-5/8	46072		
							-	-	ND22B-3/4	46073	
							-	-	ND22B-7/8	46074	
							-	-	ND22B-1	46075	
24	2.000	.625 .750 .875 1.000	1.65	.50		ND24B	09764	ND24B-5/8	46076		
							-	-	ND24B-3/4	46077	
							-	-	ND24B-7/8	46078	
							-	-	ND24B-1	46079	
30	2.500	.625	2.15	.62		ND30	09766	-	-		
32	2.667		1.92			ND32A	10276	-	-		
36	3.000		2.25			ND36A	10278	-	-		
40	3.333		2.34			ND40A	10280	-	-		
42	3.500		2.50			ND42A	10282	-	-		

12 and 10 Diametral Pitch (Steel, Non-Metallic & Cast Iron)

14-1/2° Pressure Angle (will not operate with 20° spurs)

ALL DIMENSIONS IN INCHES
ORDER BY CATALOG NUMBER OR ITEM CODE

No. of Teeth	Pitch Dia.	Bore	Hub		Style See Page 323	Without Keyway or Setscrew		With Keyway and Setscrew†		
			Dia.	Proj.		Catalog Number	Item Code	Catalog Number	Item Code	
12 DIAMETRAL PITCH						Face = .750" Outside Dia. = Pitch Dia. + .167" Overall Length = .750" + Hub Proj.				
NON-METALLIC										
15	1.250		1.00		A	QDH15	09038	-	-	
18	1.500	.500	1.25	.50		QDH18	09042	-	-	
21	1.750		1.50			QDH21	09046	-	-	
24	2.000		1.75	.50		QDH24	09050	-	-	
30	2.500	.625	2.25			QDH30	09052	-	-	
36	3.000		-	-		QD36	09026	-	-	
48	4.000		-	-		QD48	09030	-	-	
60	5.000	.750	-	-		QD60	09034	-	-	
CAST-IRON										
48	4.000					C	ND48	10284	-	-
54	4.500				ND54		10286	-	-	
60	5.000	.750	1.75	.75	ND60		10288	-	-	
64	5.333				ND64		10290	-	-	
72	6.000				ND72		10292	-	-	
84	7.000				ND84		10294	-	-	
96	8.000				D	ND96	10296	-	-	
108	9.000	.750	2.00	.75		ND108	10298	-	-	
112	9.333					ND112	10300	-	-	
120	10.000					ND120	10302	-	-	
144	12.000	.875	2.00	1.00		ND144	10304	-	-	
168	14.000					ND168	10306	-	-	
10 DIAMETRAL PITCH						Face = 1.000" Outside Dia. = Pitch Dia. + .200" Overall Length = 1.000" + Hub Proj.				
STEEL										
11	1.200*		.92	.62	A	NF11B	09778	NF11B-5/8	46080	
12	1.200	.625	.92			NF12B	09780	NF12B-5/8	46081	
14	1.400		1.02			NF14B	09782	NF14B-5/8	46082	
15	1.500	.750	1.12	.62		NF15B	09784	NF15B-3/4	46083	
16	1.600		1.22			NF16B	09786	NF16B-3/4	46084	
18	1.800	.750	1.42	.62		NF18B	09788	NF18B-3/4	46085	
		.875				-	-	NF18B-7/8	46086	
20	2.000	.750	1.62	.62		NF20B	09790	NF20B-3/4	46087	
		.875				-	-	NF20B-7/8	46088	
		1.000				-	-	NF20B-1	46089	
24	2.400	.750	2.02	.62		NF24B	09792	NF24B-3/4	46090	
		.875				-	-	NF24B-7/8	46091	
		1.000				-	-	NF24B-1	46092	
25	2.500	.750	2.12	.62		NF25	09794	-	-	
28	2.800		1.81			NF28A	10310	-	-	
30	3.000		2.02			NF30A	10312	-	-	
32	3.200	.750	2.22	.88		NF32A	10314	-	-	
35	3.500		2.52			NF35A	10316	-	-	
36	3.600		2.61			NF36A	10318	-	-	
NON-METALLIC										
15	1.500	.625	1.20	.62	A	QFH15	09062	-	-	
18	1.800		1.50			QFH18	09066	-	-	
20	2.000		1.70			QFH20	09068	-	-	
25	2.500	.750	2.20	.62		QFH25	09070	-	-	
30	3.000		2.70			QFH30	09072	-	-	

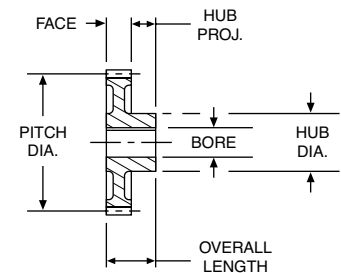

STANDARD TOLERANCES

DIMENSION	TOLERANCE
BORE	All ±.0005

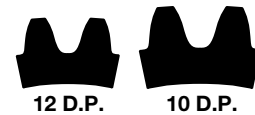

REFERENCE PAGES

- Alterations — 322
- Horsepower Ratings — 53, 54
- Lubrication — 322
- Materials — 323
- Selection Procedure — 49

*Special Pitch Diameter, used for calculating Center Distance only, not Ratio.

†All gears have standard keyway at 90° to setscrew. See Page 323.

Spur Gears

10 and 8 Diametral Pitch (Cast Iron, Steel & Non-Metallic)

14-1/2° Pressure Angle (will not operate with 20° spurs)

A

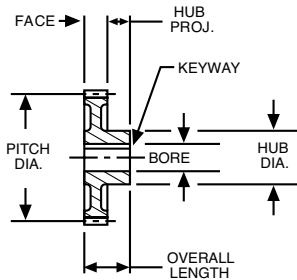

STANDARD TOLERANCES

DIMENSION		TOLERANCE
BORE	All	±.0005

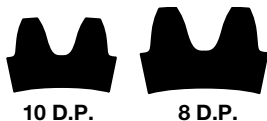

REFERENCE PAGES

- Alterations — 322
- Horsepower Ratings — 54, 55
- Lubrication — 322
- Materials — 323
- Selection Procedure — 49

*Special Pitch Diameter, used for calculating Center Distance only, not Ratio.

†All gears have standard keyway, at 90° to setscrew. See Page 323.

ALL DIMENSIONS IN INCHES
ORDER BY CATALOG NUMBER OR ITEM CODE

No. of Teeth	Pitch Dia.	Bore	Hub		Style See Page 323	Without Keyway or Setscrew		With Keyway and Setscrew†					
			Dia.	Proj.		Catalog Number	Item Code	Catalog Number	Item Code				
10 DIAMETRAL PITCH						Face = 1.000" Outside Dia. = Pitch Dia. + .200" Overall Length = 1.000" + Hub Proj.							
CAST IRON													
40	4.000	.875	2.12	.88	B	NF40	10320	-	-				
42	4.200					NF42	10322	-	-				
45	4.500					NF45	10324	-	-				
48	4.800					NF48	10326	-	-				
50	5.000					NF50	10328	-	-				
54	5.400					NF54	10330	-	-				
55	5.500					NF55	10332	-	-				
60	6.000					NF60	10334	-	-				
64	6.400					NF64	10336	-	-				
70	7.000					NF70	10338	-	-				
72	7.200					NF72	10340	-	-				
80	8.000					NF80	10342	-	-				
84	8.400					NF84	10344	-	-				
90	9.000					NF90	10346	-	-				
96	9.600					NF96	10348	-	-				
100	10.000					1.00	2.50	1.00	D	NF100	10350	-	-
110	11.000	NF110	10352	-	-								
120	12.000	NF120	10356	-	-								
140	14.000	NF140	10358	-	-								
144	14.400	NF144	10360	-	-								
160	16.000	NF160	10362	-	-								
180	18.000	NF180	10364	-	-								
8 DIAMETRAL PITCH										Face = 1.250" Outside Dia. = Pitch Dia. + .250" Overall Length = 1.250" + Hub Proj.			
STEEL													
11	1.500*	.750	1.12	.75	A					NH11B	09806	NH11B-3/4	46093
12	1.500					NH12B	09808	NH12B-3/4	46094				
14	1.750					NH14B	09810	NH14B-3/4	46095				
15	1.875					NH15B	09812	NH15B-7/8	46096				
16	2.000					.875 1.000	1.56	.75	NH16B	09814	NH16B-7/8	46097	
									-	-	NH16B-1	46098	
18	2.250					.875 1.000 1.125	1.81	.75	NH18B	09816	NH18B-7/8	46099	
									-	-	NH18B-1	46100	
									-	-	NH18B-1-1/8	46101	
20	2.500					.875 1.000 1.125	2.06	.75	NH20B	09818	NH20B-7/8	46102	
									-	-	NH20B-1	46103	
22	2.750					.875 1.000 1.125	2.31	.75	-	-	NH20B-1-1/8	46104	
									NH22B	09820	NH22B-7/8	46105	
									-	-	NH22B-1	46106	
24	3.000					1.000	2.06	.88	A	-	-	NH22B-1-1/8	46107
		NH24A	10368	-	-								
28	3.500	2.56	.88	NH28A	10370		-	-					
30	3.750	2.75	.88	NH30A	10372		-	-					
32	4.000	3.00	.88	NH32A	10374		-	-					
NON-METALLIC													
16	2.000	.750	1.62	.75	A		QHH16	09082		-	-		
18	2.250		1.88				QHH18	09084		-	-		
20	2.500		2.12				QHH20	09086		-	-		
24	3.000		2.62				QHH24	09088		-	-		
28	3.500		3.12				QHH28	09090		-	-		
							-	-		-	-		

8 and 6 Diametral Pitch (Cast Iron & Steel)

14-1/2° Pressure Angle (will not operate with 20° spurs)

ALL DIMENSIONS IN INCHES
ORDER BY CATALOG NUMBER OR ITEM CODE

No. of Teeth	Pitch Dia.	Bore	Hub		Style See Page 323	Without Keyway or Setscrew		With Keyway and Setscrew†				
			Dia.	Proj.		Catalog Number	Item Code	Catalog Number	Item Code			
8 DIAMETRAL PITCH						Face = 1.250" Outside Dia. = Pitch Dia. + .250" Overall Length = 1.250" + Hub Proj.						
CAST IRON												
36	4.500	1.000	2.50	1.00	B	NH36	10376	-	-			
40	5.000					NH40	10378	-	-			
42	5.250					NH42	10380	-	-			
44	5.500					NH44	10382	-	-			
48	6.000					NH48	10384	-	-			
54	6.750					NH54	10386	-	-			
56	7.000					NH56	10388	-	-			
60	7.500				NH60	10390	-	-				
64	8.000				NH64	10392	-	-				
72	9.000				NH72	10394	-	-				
80	10.000				1.125	3.00	1.12	D	NH80	10396	-	-
84	10.500								NH84	10398	-	-
88	11.000								NH88	10400	-	-
96	12.000								NH96	10402	-	-
112	14.000	NH112	10404	-					-			
120	15.000	NH120	10406	-					-			
128	16.000	NH128	10408	-					-			
144	18.000	NH144	10410	-					-			
160	20.000	1.125	3.25	1.25		NH160B	10412	-	-			
6 DIAMETRAL PITCH						Face = 1.500" Outside Dia. = Pitch Dia + .333" Overall Length = 1.500" + Hub Proj.						
STEEL												
11	2.000*	1.000	1.46	.88	A	NJ11B	09830	NJ11B-1	46108			
12	2.000					NJ12B	09832	NJ12B-1	46109			
14	2.333	1.000	1.79	.88		NJ14B	09834	NJ14B-1	46110			
		1.125				-	NJ14B-1-1/8	46111				
		1.250				-	NJ15B-1	46112				
		1.125				-	NJ15B-1-1/8	46113				
15	2.500	1.125	1.96	.88		-	-	NJ15B-1-3/16	46114			
		1.1875				-	NJ15B-1-1/4	46115				
		1.250				-	NJ16B-1	46116				
		1.000				-	NJ16B-1-1/8	46117				
16	2.667	1.125	2.13	.88		-	-	NJ16B-1-3/16	46118			
		1.1875				-	NJ16B-1-1/4	46119				
		1.250				-	NJ18B-1	46120				
		1.000				-	NJ18B-1-1/8	46121				
18	3.000	1.125	2.46	.88		-	-	NJ18B-1-3/16	46122			
		1.1875				-	NJ18B-1-1/4	46123				
		1.250				-	NJ20-1	46124				
		1.000				-	NJ20-1-1/8	46125				
20	3.333	1.125	2.79	.88		-	-	NJ20-1-3/16	46126			
		1.1875				-	NJ20-1-1/4	46127				
		1.250			-	-	-					
		1.000			-	-	-					
21	3.500	1.000	2.96	.88		NJ21B	09844	-	-			
24	4.000	1.125	3.00	.88		NJ24A	10414	-	-			
27	4.500		3.50			NJ27A	10416	-	-			
30	5.000		4.00			NJ30A	10418	-	-			

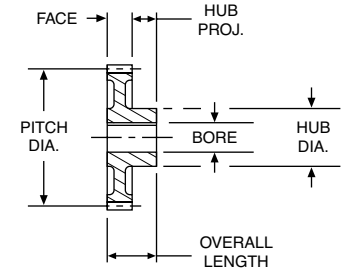

STANDARD TOLERANCES

DIMENSION	TOLERANCE
BORE	All ±.0005

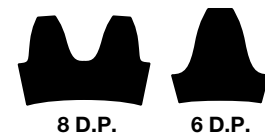

REFERENCE PAGES

- Alterations — 322
- Horsepower Ratings — 55, 56
- Lubrication — 322
- Materials — 323
- Selection Procedure — 49

*Special Pitch Diameter, used for calculating Center Distance only, not Ratio.

†All gears have standard keyway, at 90° to setscrew. See Page 323.

Spur Gears

6 and 5 Diametral Pitch (Steel & Cast Iron)

14-1/2° Pressure Angle (will not operate with 20° spurs)

A

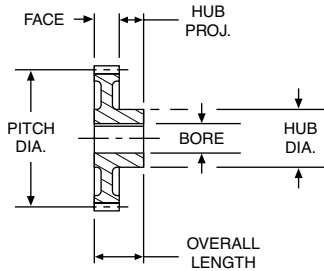

STANDARD TOLERANCES

DIMENSION		TOLERANCE
BORE	All	±.0005

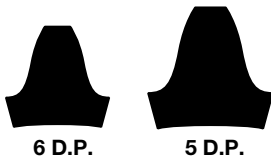

ALL DIMENSIONS IN INCHES
ORDER BY CATALOG NUMBER OR ITEM CODE

No. of Teeth	Pitch Dia.	Bore	Hub		Style See Page 323	Without Keyway or Setscrew	
			Dia.	Proj.		Catalog Number	Item Code
6 DIAMETRAL PITCH						Face = 1.500" Outside Dia. = Pitch Dia. + .333" Overall Length = 1.500" + Hub Proj.	
CAST IRON							
32	5.333	1.125	2.50	1.00	B	NJ32	10420
33	5.500					NJ33	10422
36	6.000					NJ36	10424
40	6.667					NJ40	10426
42	7.000					NJ42	10428
48	8.000					NJ48	10430
54	9.000					NJ54	10432
60	10.000	1.250	3.00	1.25	D	NJ60	10434
64	10.667					NJ64	10436
66	11.000					NJ66	10438
72	12.000					NJ72	10440
84	14.000		3.25	1.50		NJ84	10442
96	16.000					NJ96	10444
108	18.000		3.50	1.50		NJ108	10446
120	20.000					NJ120B	10448
144	24.000					NJ144B	10452
5 DIAMETRAL PITCH						Face = 1.750" Outside Dia. = Pitch Dia. + .400" Overall Length = 1.750" + Hub Proj.	
STEEL							
11	2.400*	1.0625	1.78	.88	A	NK11B	09846
12	2.400					NK12B	09848
14	2.800					NK14B	09850
15	3.000					NK15B	09852
16	3.200					NK16B	09854
18	3.600					NK18B	09856
20	4.000					NK20B	09858
CAST IRON							
24	4.800	1.0625	3.00	1.25	A	NK24B	10454
25	5.000					NK25B	10456
30	6.000					NK30B	10458
35	7.000	1.1875	3.00	1.25	B	NK35B	10460
40	8.000					NK40B	10462
45	9.000					NK45B	10464
50	10.000	1.1875	3.50	1.25	D	NK50B	10466
55	11.000					NK55B	10468
60	12.000					NK60B	10470
70	14.000					NK70B	10472
80	16.000					NK80B	10474
100	20.000					1.3125	3.75

*Special Pitch Diameter, used for calculating Center Distance only, not Ratio.

REFERENCE PAGES

- Alterations — 322
- Horsepower Ratings — 56
- Lubrication — 322
- Materials — 323
- Selection Procedure — 49

4 and 3 Diametral Pitch (Steel & Cast Iron)

14-1/2° Pressure Angle (will not operate with 20° spurs)

ALL DIMENSIONS IN INCHES
ORDER BY CATALOG NUMBER OR ITEM CODE

No. of Teeth	Pitch Dia.	Bore	Hub		Style See Page 323	Without Keyway or Setscrew					
			Dia.	Proj.		Catalog Number	Item Code				
4 DIAMETRAL PITCH											
						Face = 2.000" Outside Dia. = Pitch Dia. + .500" Overall Length = 2.000" + Hub Proj.					
STEEL											
11	3.000*	1.125	2.27	.88	A	NL11B	09860				
12	3.000		2.27			NL12B	09862				
14	3.500		2.77			NL14B	09864				
15	3.750		3.02			NL15B	09866				
16	4.000		3.27			NL16B	09868				
18	4.500		3.77			NL18B	09870				
20	5.000		4.27			NL20B	09872				
22	5.500		4.77			NL22B	09874				
CAST IRON											
24	6.000		1.125			3.50	1.50	A	NL24B	10484	
28	7.000	4.00		B	NL28B			10486			
30	7.500			NL30	10488						
32	8.000			NL32B	10490						
36	9.000			NL36B	10492						
40	10.000			1.250	1.50	C	NL40B	10494			
42	10.500	NL42				10496					
44	11.000	4.00				1.50	D	NL44B	10498		
48	12.000							NL48B	10500		
54	13.500							NL54	10502		
56	14.000		NL56B	10504							
60	15.000		NL60	10506							
64	16.000	1.375	4.50	1.75	NL64B	10508					
72	18.000				NL72B	10510					
80	20.000				NL80B	10512					
84	21.000				NL84	10514					
88	22.000	1.75	1.75	D	NL88B	10516					
96	24.000				NL96B	10518					
3 DIAMETRAL PITCH											
						Face = 3.000"† Outside Dia. = Pitch Dia. + .667" Overall Length = Face + Hub Proj.					
STEEL											
11	4.000*	1.3125	-	-	A	NO11B†	09876				
12	4.000					NO12B†	09878				
14	4.667					NO14B	09880				
15	5.000					NO15B	09882				
16	5.333					NO16B	09884				
18	6.000					NO18B	09886				
20	6.667					NO20	09888				
21	7.000					NO21B	09890				
CAST IRON											
24	8.000					1.4375	4.50	1.25	B	NO24B	10524
30	10.000						5.25	1.75		C	NO30B
36	12.000	5.25	1.75	D	NO36B			10528			
42	14.000		5.25		1.75		NO42	10530			
48	16.000	1.5625	5.25	1.75	D	NO48B	10532				
60	20.000					NO60B	10536				
72	24.000	1.6875	5.50	1.75	D	NO72B	10538				
84	28.000		5.75			NO84B	10540				
96	32.000	1.9375	5.75	1.75	D	NO96B	10542				
108	36.000					NO108B	10544				

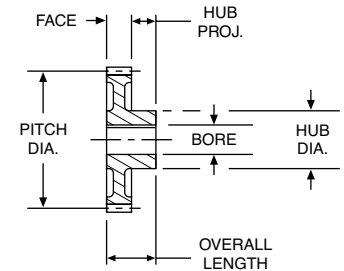

STANDARD TOLERANCES

DIMENSION	TOLERANCE
BORE	All ±.0005

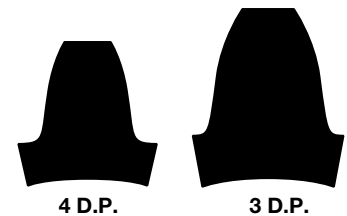

REFERENCE PAGES

- Alterations — 322
- Horsepower Ratings — 56, 57
- Lubrication — 322
- Materials — 323
- Selection Procedure — 49

*Special Pitch Diameter, used for calculating Center Distance only, not Ratio.
†NO11B and NO12B have 4" Face.

Change Gears

20 Diametral Pitch (Steel & Cast Iron)

14-1/2° Pressure Angle (will not operate with 20° spurs)

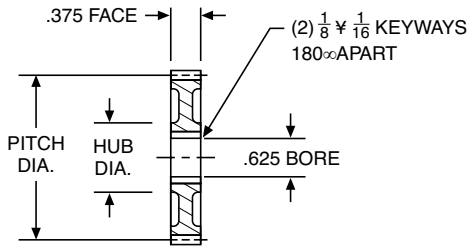

REFERENCE PAGES

- Alterations — 322
- Horsepower Ratings — 51
- Lubrication — 322
- Materials — 323
- Selection Procedure — 49



COMPOUND STEEL BUSHINGS

These steel bushings have 2 keys, 180° apart and fit bores of GA series change gears with a slip fit. They are used to mount two gears on one shaft (or stud) and drive one from the other.

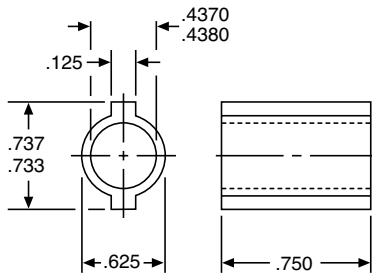

ORDER BY CATALOG NUMBER OR ITEM CODE

CATALOG NO.	ITEM CODE
GAB20A	18500

ALL DIMENSIONS IN INCHES
ORDER BY CATALOG NUMBER OR ITEM CODE

No. of Teeth	Pitch Dia.	Hub Dia.	Catalog Number	Item Code	No. of Teeth	Pitch Dia.	Hub Dia.	Catalog Number	Item Code
20 DIAMETRAL PITCH									
Outside Dia. = Pitch Dia. + .100"									
STEEL					CAST IRON				
20	1.000		GA20	10038	71	3.550		GA71B	10842
21	1.050		GA21	10040	72	3.600		GA72B	10844
22	1.100		GA22	10042	73	3.650		GA73B	10846
23	1.150		GA23	10044	74	3.700		GA74B	10848
24	1.200		GA24	10046	75	3.750	1.56	GA75B	10850
25	1.250		GA25	10048	76	3.800		GA76B	10852
26	1.300		GA26	10050	77	3.850		GA77B	10854
27	1.350		GA27	10052	78	3.900		GA78B	10856
28	1.400		GA28	10054	79	3.950		GA79B	10858
29	1.450		GA29	10056	80	4.000		GA80B	10860
30	1.500		GA30	10058	81	4.050		GA81B	10862
31	1.550		GA31	10060	82	4.100		GA82B	10864
32	1.600		GA32	10062	83	4.150		GA83B	10866
33	1.650		GA33	10064	84	4.200		GA84B	10868
34	1.700		GA34	10066	85	4.250		GA85B	10870
35	1.750		GA35	10068	86	4.300		GA86B	10872
36	1.800		GA36	10070	87	4.350		GA87B	10874
37	1.850		GA37	10072	88	4.400		GA88B	10876
38	1.900		GA38	10074	89	4.450		GA89B	10878
39	1.950		GA39	10076	90	4.500		GA90B	10880
40	2.000		GA40	10078	91	4.550		GA91B	10882
41	2.050		GA41	10080	92	4.600		GA92B	10884
42	2.100		GA42	10082	93	4.650		GA93B	10886
43	2.150		GA43	10084	94	4.700		GA94B	10888
44	2.200		GA44	10086	95	4.750		GA95B	10890
45	2.250		GA45	10088	96	4.800		GA96B	10892
46	2.300		GA46	10090	97	4.850		GA97B	10894
47	2.350		GA47	10092	98	4.900	1.69	GA98B	10896
48	2.400		GA48	10094	99	4.950		GA99B	10898
49	2.450		GA49	10096	100	5.000		GA100B	10900
50	2.500		GA50	10098	101	5.050		GA101B	10902
CAST IRON					102	5.100		GA102B	10904
51	2.550		GA51B	10802	103	5.150		GA103B	10906
52	2.600		GA52B	10804	104	5.200		GA104B	10908
53	2.650		GA53B	10806	105	5.250		GA105B	10910
54	2.700		GA54B	10808	106	5.300		GA106B	10912
55	2.750		GA55B	10810	107	5.350		GA107B	10914
56	2.800		GA56B	10812	108	5.400		GA108B	10916
57	2.850		GA57B	10814	109	5.450		GA109B	10918
58	2.900	1.38	GA58B	10816	110	5.500		GA110B	10920
59	2.950		GA59B	10818	111	5.550		GA111B	10922
60	3.000		GA60B	10820	112	5.600		GA112B	10924
61	3.050		GA61B	10822	113	5.650		GA113B	10926
62	3.100		GA62B	10824	114	5.700		GA114B	10928
63	3.150		GA63B	10826	115	5.750		GA115B	10930
64	3.200		GA64B	10828	116	5.800		GA116B	10932
65	3.250		GA65B	10830	117	5.850		GA117B	10934
66	3.300		GA66B	10832	118	5.900		GA118B	10936
67	3.350	1.56	GA67B	10834	119	5.950		GA119B	10938
68	3.400		GA68B	10836	120	6.000		GA120B	10940
69	3.450		GA69B	10838					
70	3.500		GA70B	10840					

Style See Page 323	20 – 78 Teeth – A 79 – 120 Teeth – C
--------------------	---

16 Diametral Pitch (Steel & Cast Iron)

14-1/2° Pressure Angle (will not operate with 20° spurs)

ALL DIMENSIONS IN INCHES
ORDER BY CATALOG NUMBER OR ITEM CODE

No. of Teeth	Pitch Dia.	Hub Dia.	Catalog Number	Item Code	No. of Teeth	Pitch Dia.	Hub Dia.	Catalog Number	Item Code
16 DIAMETRAL PITCH									
Outside Dia. = Pitch Dia. + .125"									
STEEL					CAST IRON				
20	1.250		GB20	10100	76	4.750		GB76B	11012
21	1.313		GB21	10102	77	4.813		GB77B	11014
22	1.375		GB22	10104	78	4.875		GB78B	11016
23	1.438		GB23	10106	79	4.938		GB79B	11018
24	1.500		GB24	10108	80	5.000		GB80B	11020
25	1.563		GB25	10110	81	5.063		GB81B	11022
26	1.625		GB26	10112	82	5.125		GB82A	11024
27	1.688		GB27	10114	83	5.188		GB83A	11026
28	1.750		GB28	10116	84	5.250		GB84A	11028
29	1.813		GB29	10118	85	5.313		GB85A	11030
30	1.875	-	GB30	10120	86	5.375		GB86A	11032
31	1.938		GB31	10122	87	5.438		GB87A	11034
32	2.000		GB32	10124	88	5.500		GB88A	11036
33	2.063		GB33	10126	89	5.563		GB89A	11038
34	2.125		GB34	10128	90	5.625		GB90A	11040
35	2.188		GB35	10130	91	5.688		GB91A	11042
36	2.250		GB36	10132	92	5.750		GB92A	11044
37	2.313		GB37	10134	93	5.813		GB93A	11046
38	2.375		GB38	10136	94	5.875		GB94A	11048
39	2.438		GB39	10138	95	5.938		GB95A	11050
40	2.500		GB40	10140	96	6.000		GB96A	11052
CAST IRON					97	6.063		GB97A	11054
41	2.563		GB41B	10942	98	6.125		GB98A	11056
42	2.625		GB42B	10944	99	6.188		GB99A	11058
43	2.688		GB43B	10946	100	6.250		GB100A	11060
44	2.750		GB44B	10948	101	6.313	1.81	GB101A	11062
45	2.913		GB45B	10950	102	6.375		GB102A	11064
46	2.875	1.56	GB46B	10952	103	6.438		GB103A	11066
47	2.938		GB47B	10954	104	6.500		GB104A	11068
48	3.000		GB48B	10956	105	6.563		GB105A	11070
49	3.063		GB49B	10958	106	6.625		GB106A	11072
50	3.125		GB50B	10960	107	6.688		GB107A	11074
51	3.188		GB51B	10962	108	6.750		GB108A	11076
52	3.250		GB52B	10964	109	6.913		GB109A	11078
53	3.313		GB53B	10966	110	6.975		GB110A	11080
54	3.375		GB54B	10968	111	6.938		GB111A	11082
55	3.438		GB55B	10970	112	7.000		GB112A	11084
56	3.500		GB56B	10972	113	7.063		GB113A	11086
57	3.563		GB57B	10974	114	7.125		GB114A	11088
58	3.625		GB58B	10976	115	7.188		GB115A	11090
59	3.688		GB59B	10978	116	7.250		GB116A	11092
60	3.750		GB60B	10980	117	7.313		GB117A	11094
61	3.813		GB61B	10982	118	7.375		GB118A	11096
62	3.875		GB62B	10984	119	7.438		GB119A	11098
63	3.938		GB63B	10986	120	7.500		GB120A	11100
64	4.000	1.81	GB64B	10988	121	7.563		GB121A	11102
65	4.063		GB65B	10990	122	7.625		GB122A	11104
66	4.125		GB66B	10992	123	7.688		GB123A	11106
67	4.188		GB67B	10994	124	7.750		GB124A	11108
68	4.250		GB68B	10996	125	7.813		GB125A	11110
69	4.313		GB69B	10998	126	7.875		GB126A	11112
70	4.375		GB70B	11000	127	7.938		GB127A	11114
71	4.438		GB71B	11002	128	8.000		GB128A	11116
72	4.500		GB72B	11004					
73	4.563		GB73B	11006					
74	4.625		GB74B	11008					
75	4.688		GB75B	11010					

Style See Page 323	20 - 79 Teeth - A
	80 - 128 Teeth - C

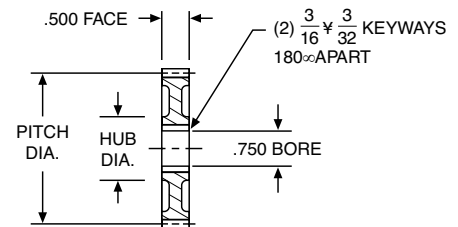

REFERENCE PAGES

- Alterations — 322
- Horsepower Ratings — 52
- Lubrication — 322
- Materials — 323
- Selection Procedure — 49

COMPOUND STEEL BUSHINGS

These steel bushings have 2 keys, 180° apart and fit bores of GB series change gears with a slip fit. They are used to mount two gears on one shaft (or stud) and drive one from the other.

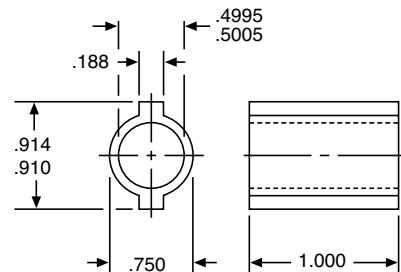

ORDER BY CATALOG NUMBER OR ITEM CODE

CATALOG NO.	ITEM CODE
GBB16A	18502

Change Gears

12 Diametral Pitch (Steel & Cast Iron)

14-1/2° Pressure Angle (will not operate with 20° spurs)

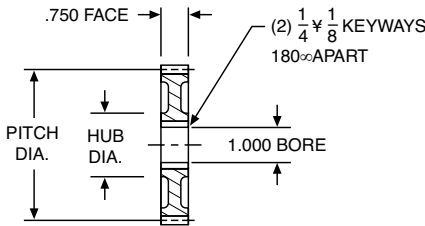

REFERENCE PAGES

- Alterations — 322
- Horsepower Ratings — 53
- Lubrication — 322
- Materials — 323
- Selection Procedure — 49

Compound Steel Bushings

These steel bushings have 2 keys, 180° apart and fit bores of GD series change gears with a slip fit. They are used to mount two gears on one shaft (or stud) and drive one from the other.

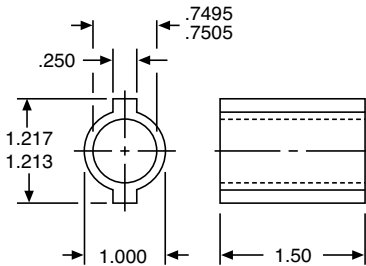

ALL DIMENSIONS IN INCHES
ORDER BY CATALOG NUMBER OR ITEM CODE

No. of Teeth	Pitch Dia.	Hub Dia.	Catalog Number	Item Code	No. of Teeth	Pitch Dia.	Hub Dia.	Catalog Number	Item Code
12 DIAMETRAL PITCH									
STEEL					CAST IRON				
Outside Dia. = Pitch Dia. + .167"									
20	1.667		GD20	10142	75	6.250		GD75A	11194
21	1.750		GD21	10144	76	6.333		GD76A	11196
22	1.833		GD22	10146	77	6.417		GD77A	11198
23	1.917		GD23	10148	78	6.500		GD78A	11200
24	2.000		GD24	10150	79	6.583	2.19	GD79A	11202
25	2.083		GD25	10152	80	6.667		GD80A	11204
26	2.167		GD26	10154	81	6.750		GD81A	11206
27	2.250		GD27	10156	82	6.833		GD82A	11208
28	2.333		GD28	10158	83	6.917		GD83A	11210
29	2.417		GD29	10160	84	7.000		GD84A	11212
30	2.500		GD30	10162	85	7.083		GD85A	11214
31	2.583		GD31	10164	86	7.167		GD86A	11216
32	2.667		GD32	10166	87	7.250		GD87A	11218
33	2.750		GD33	10168	88	7.333		GD88A	11220
34	2.833		GD34	10170	89	7.417		GD89A	11222
35	2.917		GD35	10172	90	7.500		GD90A	11224
36	3.000		GD36	10174	91	7.583		GD91A	11226
CAST IRON					92	7.667		GD92A	11228
37	3.083		GD37B	11118	93	7.750		GD93A	11230
38	3.167		GD38B	11120	94	7.833		GD94A	11232
39	3.250		GD39B	11122	95	7.917		GD95A	11234
40	3.333		GD40B	11124	96	8.000		GD96A	11236
41	3.417		GD41B	11126	97	8.083		GD97A	11238
42	3.500	1.76	GD42B	11128	98	8.167		GD98A	11240
43	3.583		GD43B	11130	99	8.250		GD99A	11242
44	3.667		GD44B	11132	100	8.333	2.44	GD100A	11244
45	3.750		GD45B	11134	101	8.417		GD101A	11246
46	3.833		GD46B	11136	102	8.500		GD102A	11248
47	3.917		GD47B	11138	103	8.583		GD103A	11250
48	4.000		GD48B	11140	104	8.667		GD104A	11252
49	4.083		GD49B	11142	105	8.750		GD105A	11254
50	4.167		GD50B	11144	106	8.833		GD106A	11256
51	4.250		GD51B	11146	107	8.917		GD107A	11258
52	4.333		GD52B	11148	108	9.000		GD108A	11260
53	4.417		GD53B	11150	109	9.083		GD109A	11262
54	4.500		GD54B	11152	110	9.167		GD110A	11264
55	4.583		GD55B	11154	111	9.250		GD111A	11266
56	4.667		GD56B	11156	112	9.333		GD112A	11268
57	4.750		GD57B	11158	113	9.417		GD113A	11270
58	4.833		GD58B	11160	114	9.500		GD114A	11272
59	4.917		GD59B	11162	115	9.583		GD115A	11274
60	5.000	2.19	GD60B	11164	116	9.667		GD116A	11276
61	5.083		GD61B	11166	117	9.750		GD117A	11278
62	5.167		GD62B	11168	118	9.833		GD118A	11280
63	5.250		GD63A	11170	119	9.917		GD119A	11282
64	5.333		GD64A	11172	120	10.000		GD120A	11284
65	5.417		GD65A	11174					
66	5.500		GD66A	11176					
67	5.583		GD67A	11178					
68	5.667		GD68A	11180					
69	5.750		GD69A	11182					
70	5.833		GD70A	11184					
71	5.917		GD71A	11186					
72	6.000		GD72A	11188					
73	6.083		GD73A	11190					
74	6.167		GD74A	11192					

Style See Page 323	20 – 60 Teeth – A 61 – 120 Teeth – C
--------------------	---

ORDER BY CATALOG NUMBER
OR ITEM CODE

CATALOG NO.	ITEM CODE
GDB12A	18504

10 Diametral Pitch (Steel & Cast Iron)

14-1/2° Pressure Angle (will not operate with 20° spurs)

ALL DIMENSIONS IN INCHES
ORDER BY CATALOG NUMBER OR ITEM CODE

No. of Teeth	Pitch Dia.	Hub Dia.	Catalog Number	Item Code	No. of Teeth	Pitch Dia.	Hub Dia.	Catalog Number	Item Code
10 DIAMETRAL PITCH									
STEEL					CAST IRON				
Outside Dia. = Pitch Dia. +.200"									
20	2.000		GF20	10176	61	6.100		GF61A	11346
21	2.100		GF21	10178	62	6.200		GF62A	11348
22	2.200		GF22	10180	63	6.300		GF63A	11350
23	2.300		GF23	10182	64	6.400		GF64A	11352
24	2.400		GF24	10184	65	6.500		GF65A	11354
25	2.500	-	GF25	10186	66	6.600		GF66A	11356
26	2.600		GF26	10188	67	6.700		GF67A	11358
27	2.700		GF27	10190	68	6.800		GF68A	11360
28	2.800		GF28	10192	69	6.900		GF69A	11362
29	2.900		GF29	10194	70	7.000		GF70A	11364
30	3.000		GF30	10196	71	7.100		GF71A	11366
CAST IRON					72	7.200		GF72A	11368
31	3.100		GF31B	11286	73	7.300		GF73A	11370
32	3.200		GF32B	11288	74	7.400		GF74A	11372
33	3.300		GF33B	11290	75	7.500		GF75A	11374
34	3.400		GF34B	11292	76	7.600		GF76A	11376
35	3.500		GF35B	11294	77	7.700		GF77A	11378
36	3.600	1.94	GF36B	11296	78	7.800		GF78A	11380
37	3.700		GF37B	11298	79	7.900		GF79A	11382
38	3.800		GF38B	11300	80	8.000		GF80A	11384
39	3.900		GF39B	11302	81	8.100	3.12	GF81A	11386
40	4.000		GF40B	11304	82	8.200		GF82A	11388
41	4.100		GF41B	11306	83	8.300		GF83A	11390
42	4.200		GF42B	11308	84	8.400		GF84A	11392
43	4.300		GF43B	11310	85	8.500		GF85A	11394
44	4.400		GF44B	11312	86	8.600		GF86A	11396
45	4.500		GF45B	11314	87	8.700		GF87A	11398
46	4.600		GF46B	11316	88	8.800		GF88A	11400
47	4.700		GF47B	11318	89	8.900		GF89A	11402
48	4.800	2.68	GF48B	11320	90	9.000		GF90A	11404
49	4.900		GF49B	11322	91	9.100		GF91A	11406
50	5.000		GF50B	11324	92	9.200		GF92A	11408
51	5.100		GF51B	11326	93	9.300		GF93A	11410
52	5.200		GF52A	11328	94	9.400		GF94A	11412
53	5.300		GF53A	11330	95	9.500		GF95A	11414
54	5.400		GF54A	11332	96	9.600		GF96A	11416
55	5.500		GF55A	11334	97	9.700		GF97A	11418
56	5.600		GF56A	11336	98	9.800		GF98A	11420
57	5.700	3.12	GF57A	11338	99	9.900		GF99A	11422
58	5.800		GF58A	11340	100	10.000		GF100A	11424
59	5.900		GF59A	11342					
60	6.000		GF60A	11344					

Style	20 - 60 Teeth - A
See	61 - 66 Teeth - B
Page	67 - 100 Teeth - C
323	

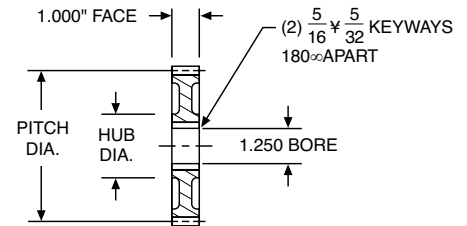

REFERENCE PAGES

- Alterations — 322
- Horsepower Ratings — 54
- Lubrication — 322
- Materials — 323
- Selection Procedure — 49

Compound Steel Bushings

These steel bushings have 2 keys, 180° apart and fit bores of GF series change gears with a slip fit. They are used to mount two gears on one shaft (or stud) and drive one from the other.

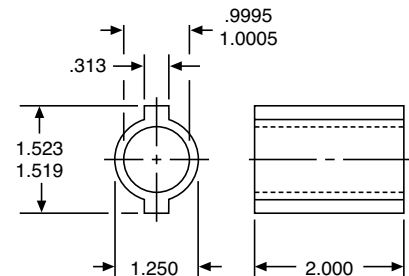

ORDER BY CATALOG NUMBER
OR ITEM CODE

CATALOG NO.	ITEM CODE
GFB10A	18506

A

Change Gears

8 Diametral Pitch (Steel & Cast Iron)

14-1/2° Pressure Angle (will not operate with 20° spurs)



A

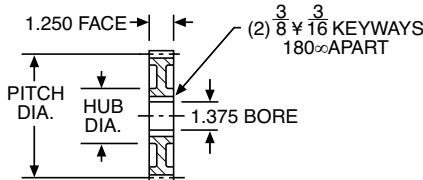

REFERENCE PAGES

- Alterations — 322
- Horsepower Ratings — 55
- Lubrication — 322
- Materials — 323
- Selection Procedure — 49

Compound Steel Bushings

These steel bushings have 2 keys, 180° apart and fit bores of GH series change gears with a slip fit. They are used to mount two gears on one shaft (or stud) and drive one from the other.

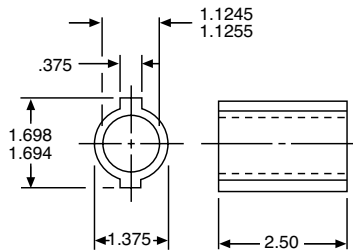

ORDER BY CATALOG NUMBER OR ITEM CODE

CATALOG NO.	ITEM CODE
GHB8A	18508

ALL DIMENSIONS IN INCHES
ORDER BY CATALOG NUMBER OR ITEM CODE

No. of Teeth	Pitch Dia.	Hub Dia.	Catalog Number	Item Code	No. of Teeth	Pitch Dia.	Hub Dia.	Catalog Number	Item Code
8 DIAMETRAL PITCH									
					Outside Dia. = Pitch Dia. + .250"				
STEEL					CAST IRON				
20	2.500	—	GH20	10198	61	7.625		GH61A	11498
21	2.625	—	GH21	10200	62	7.750		GH62A	11500
22	2.750	—	GH22	10202	63	7.875		GH63A	11502
23	2.875	—	GH23	10204	64	8.000		GH64A	11504
24	3.000	—	GH24	10206	65	8.125		GH65A	11506
CAST IRON					66	8.250		GH66A	11508
25	3.125		GH25B	11426	67	8.375		GH67A	11510
26	3.250		GH26B	11428	68	8.500		GH68A	11512
27	3.375		GH27B	11430	69	8.625		GH69A	11514
28	3.500		GH28B	11432	70	8.750	3.25	GH70A	11516
29	3.625		GH29B	11434	71	8.875		GH71A	11518
30	3.750	2.06	GH30B	11436	72	9.000		GH72A	11520
31	3.875		GH31B	11438	73	9.125		GH73A	11522
32	4.000		GH32B	11440	74	9.250		GH74A	11524
33	4.125		GH33B	11442	75	9.375		GH75A	11526
34	4.250		GH34B	11444	76	9.500		GH76A	11528
35	4.375		GH35B	11446	77	9.625		GH77A	11530
36	4.500		GH36B	11448	78	9.750		GH78A	11532
37	4.625		GH37B	11450	79	9.875		GH79A	11534
38	4.750		GH38B	11452	80	10.000		GH80A	11536
39	4.875		GH39B	11454	81	10.125		GH81A	11538
40	5.000	2.69	GH40B	11456	82	10.250		GH82A	11540
41	5.125		GH41A	11458	83	10.375		GH83A	11542
42	5.250		GH42A	11460	84	10.500		GH84A	11544
43	5.375		GH43A	11462	85	10.625		GH85A	11546
44	5.500		GH44A	11464	86	10.750		GH86A	11548
45	5.625		GH45A	11466	87	10.875		GH87A	11550
46	5.750		GH46A	11468	88	11.000	3.75	GH88A	11552
47	5.875		GH47A	11470	89	11.125		GH89A	11554
48	6.000		GH48A	11472	90	11.250		GH90A	11556
49	6.125		GH49A	11474	91	11.375		GH91A	11558
50	6.250		GH50A	11476	92	11.500		GH92A	11560
51	6.375	3.12	GH51A	11478	93	11.625		GH93A	11562
52	6.500		GH52A	11480	94	11.750		GH94A	11564
53	6.625		GH53A	11482	95	11.875		GH95A	11566
54	6.750		GH54A	11484	96	12.000		GH96A	11568
55	6.875		GH55A	11486	97	12.125		GH97A	11570
56	7.000		GH56A	11488	98	12.250		GH98A	11572
57	7.125		GH57A	11490	99	12.375		GH99A	11574
58	7.250		GH58A	11492	100	12.500		GH100A	11576
59	7.375	3.25	GH59A	11494					
60	7.500		GH60A	11496					

Style	20 – 49 Teeth – A
See	50 – 57 Teeth – B
Page	58 – 68 Teeth – C
323	69 – 100 Teeth – D

Stem Pinions

20 through 6 Diametral Pitch (Steel)

14-1/2° Pressure Angle (will not operate with 20° spurs)

Boston Gear Stem Pinions feature small numbers of teeth cut integral on a steel shaft. Undercutting of the teeth is minimized by the use of special enlarged Pitch Diameters. When run with standard stock spur gears, they provide high ratios not normally found in spur gear drives. They are not intended to be operated with each other, with internal gears or with 11 tooth pinions, but will run satisfactorily with all other standard 14½° Pressure Angle spur gears.

ALL DIMENSIONS IN INCHES
ORDER BY CATALOG NUMBER OR ITEM CODE

No. of Teeth	Pitch Dia.*	Stem Dia.	Stem Length	Overall Length	Catalog Number	Item Code
20 DIAMETRAL PITCH FACE = 1.125"						
5	.287	.375	2.875	4.500	NAR5	09654
6	.335	.375	2.875	4.500	NAR6	09656
8	.430	.500	3.375	5.000	NAR8	09658
10	.525	.625	3.375	5.000	NAR10	09660
16 DIAMETRAL PITCH FACE = 1.375"						
5	.359	.4375	3.125	5.000	NBR5	09696
6	.419	.500	3.125	5.000	NBR6	09698
8	.537	.625	3.375	5.250	NBR8	09700
10	.656	.750	3.375	5.250	NBR10	09702
12 DIAMETRAL PITCH FACE = 2.000"						
5	.479	.625	4.375	7.250	NDR5	09734
6	.558	.625	4.375	7.250	NDR6	09736
7	.637	.750	4.375	7.250	NDR7	09738
8	.716	.875	4.375	7.250	NDR8	09740
10	.875	1.000	4.375	7.250	NDR10	09742
10 DIAMETRAL PITCH FACE = 2.250"						
5	.575	.750	4.375	7.500	NFR5	09768
6	.670	.750	4.375	7.500	NFR6	09770
7	.765	.875	4.375	7.500	NFR7	09772
8	.860	1.000	4.375	7.500	NFR8	09774
10	1.050	1.125	4.375	7.500	NFR10	09776
8 DIAMETRAL PITCH FACE = 2.500"						
5	.718	.875	4.375	7.750	NHR5	09796
6	.837	1.000	4.375	7.750	NHR6	09798
7	.956	1.125	4.375	7.750	NHR7	09800
8	1.075	1.125	4.375	7.750	NHR8	09802
10	1.312	1.500	4.375	7.750	NHR10	09804
6 DIAMETRAL PITCH FACE = 3.000"						
5	.958	1.250	4.375	8.500	NJR5	09822
6	1.116	1.375	4.375	8.500	NJR6	09824
8	1.433	1.625	5.000	9.000	NJR8	09826
10	1.750	2.000	5.375	9.500	NJR10	09828

*Used for calculating Center Distance, not ratio.

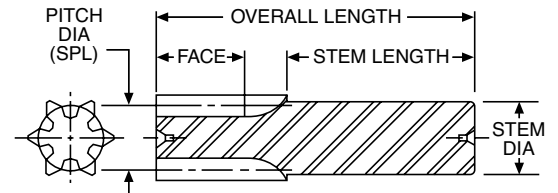
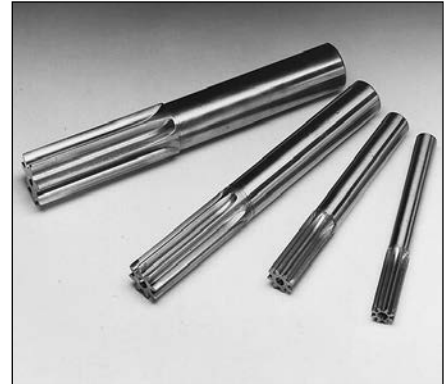

STANDARD TOLERANCES

DIMENSION	TOLERANCE
STEM DIA.	All +.0000 - .0015

Drawn Pinion Wire

48, 32 and 24 Diametral Pitch (Brass & Steel)

14-1/2° Pressure Angle (will not operate with 20° spurs)

A

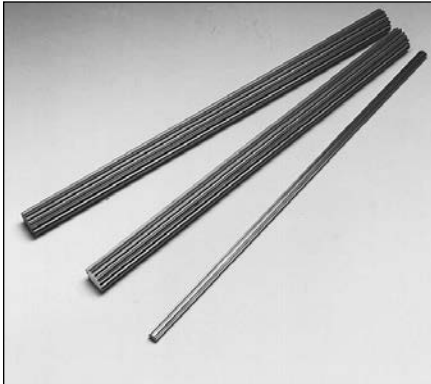

Drawn Pinion Wire, teeth not generated. All Pinion Wire is stocked in 4 foot pieces. Other lengths can be furnished on special order. Price on application.

ALL DIMENSIONS IN INCHES
ORDER BY CATALOG NUMBER OR ITEM CODE

No. of Teeth	Pitch Dia.	Catalog Number	Item Code
48			
DIAMETRAL PITCH			
BRASS			
6	.125	G24	36900
8	.167	G25	36902
9	.188	G26	36904
10	.208	G27	36906
12	.250	G29	36908
14	.292	G30	36910
15	.312	G31	36912
16	.333	G32	36914
18	.375	G33	36916
STEEL			
6	.125	GS24	36954
8	.167	GS25	36956
9	.188	GS26	36958
10	.208	GS27	36960
12	.250	GS29	36962
14	.292	GS30	36964
15	.312	GS31	36966
16	.333	GS32	36968
18	.375	GS33	36970
32			
DIAMETRAL PITCH			
BRASS			
6	.188	G39	36918
8	.250	G40	36920
9	.281	G41	36922
10	.312	G42	36924
11	.344	G43	36926
12	.375	G44	36928
14	.438	G45	36930
15	.469	G46	36932
16	.500	G47	36934
STEEL			
6	.188	GS39	36972
8	.250	GS40	36974
9	.281	GS41	36976
10	.312	GS42	36978
11	.344	GS43	36980
12	.375	GS44	36982
14	.438	GS45	36984
15	.469	GS46	36986
16	.500	GS47	36988
24			
DIAMETRAL PITCH			
BRASS			
6	.250	G54	36936
9	.375	G56	36940
10	.417	G57	36942
12	.500	G59	36946
14	.583	G60	36948
15	.625	G61	36950
16	.667	G62	36952
STEEL			
6	.250	GS54	36990
8	.333	GS55	36992
9	.375	GS56	36994
10	.417	GS57	36996
11	.458	GS58	36998
12	.500	GS59	37000
14	.583	GS60	37002
15	.625	GS61	37004
16	.667	GS62	37006

48 through 3 Diametral Pitch (Nylon & Steel) 14-1/2° Pressure Angle (will not operate with 20° spurs)

ALL DIMENSIONS IN INCHES
ORDER BY CATALOG NUMBER OR ITEM CODE

Overall Thickness	Pitch Line to Back (B)	Nominal Length (Feet)	Mating Spur Gear Page #	Nylon		Steel	
				Catalog Number	Item Code	Catalog Number	Item Code
48 DIAMETRAL PITCH				FACE WIDTH = .125"			
.125	.104	1/2	18	GP586-1	53899	-	-
				-	-	L501-2	12726
32 DIAMETRAL PITCH				FACE WIDTH = .188"			
.188	.156	1/2	18, 19	GP583-1	53900	-	-
		2/4		-	-	L503-2	12728
				-	-	L503-4	12730
24 DIAMETRAL PITCH				FACE WIDTH = .250"			
.250	.208	1/2	19, 20	GP579-1	53901	-	-
		2/4		-	-	L505-2	12732
				-	-	L505-4	12734
20 DIAMETRAL PITCH				FACE WIDTH = .375"			
.375	.325	2/4	20, 21	-	-	L509-2	12736
		4/6		-	-	L509-4	12738
				-	-	L509-6	12740
16 DIAMETRAL PITCH				*FACE WIDTH = .313"			
.313	.250	2/4	21, 22	-	-	L510-2	12742
				-	-	L510-4	12744
16 DIAMETRAL PITCH				*FACE WIDTH = .500"			
.500	.438	4/6	21, 22	-	-	L512-4	12746
				-	-	L512-6	12748
12 DIAMETRAL PITCH				FACE WIDTH = .750"			
.500	.417	4/6	22, 23	-	-	L514-4	12750
				-	-	L514-6	12752
.750	.667	4/6		-	-	L515-4	12754
				-	-	L515-6	12756
10 DIAMETRAL PITCH				FACE WIDTH = 1.000"			
.625	.525	4/6	23, 24	-	-	L516-4	37324
				-	-	L516-6	37326
1.000	.900	4/6		-	-	L517-4	37328
				-	-	L517-6	37330
8 DIAMETRAL PITCH				FACE WIDTH = 1.250"			
.750	.625	4/6	24, 25	-	-	L518-4	37332
				-	-	L518-6	37334
1.250	1.125	4/6		-	-	L519-4	37336
				-	-	L519-6	37338
6 DIAMETRAL PITCH				FACE WIDTH = 1.500"			
1.000	.833	4/6	25, 26	-	-	L520-4	37340
				-	-	L520-6	37342
1.500	1.333	4/6		-	-	L521-4	37344
				-	-	L521-6	37346
5 DIAMETRAL PITCH				FACE WIDTH = 1.750"			
1.250	1.050	4/6	26	-	-	L522-4	37348
				-	-	L522-6	37350
4 DIAMETRAL PITCH				FACE WIDTH = 2.000"			
1.500	1.250	4/6	27	-	-	L523-4	37352
				-	-	L523-6	37354
3 DIAMETRAL PITCH				FACE WIDTH = 3.000"			
1.500	1.167	4/6	27	-	-	L524-4	37356
				-	-	L524-6	37358

*Face Width of L512-4 and L512-6 = 1/2".

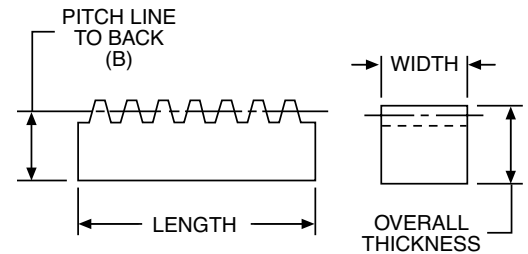
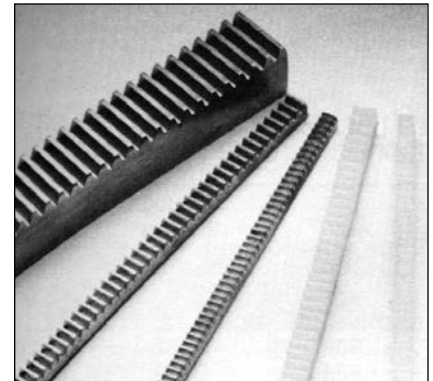

STANDARD TOLERANCES†

DIMENSION	TOLERANCE
LENGTH†	All + 1.00 - .000
FACE WIDTH	1/8 - 3/4 + .000 - .002
	1 - 1-1/2 + .000 - .003
	1-3/4 - 2 + .000 - .004
	3 + .000 - .006

†Ends not machined. Tolerance allows for cutting and matching. Nylon Rack is molded in proper lengths to permit end to end butting without interruption of tooth spacing.

‡Steel only.

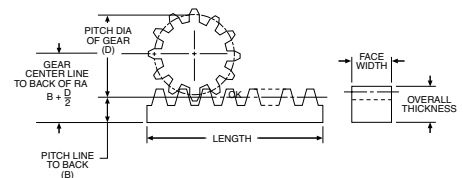

REFERENCE PAGES

Alterations — 322
Lubrication — 322
Materials — 323

Internal Gears

48 through 16 Diametral Pitch (Brass)

14-1/2° Pressure Angle (will not operate with 20° spurs)

A

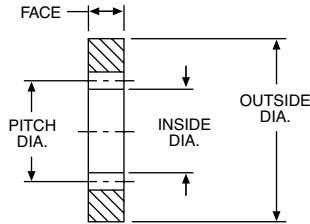
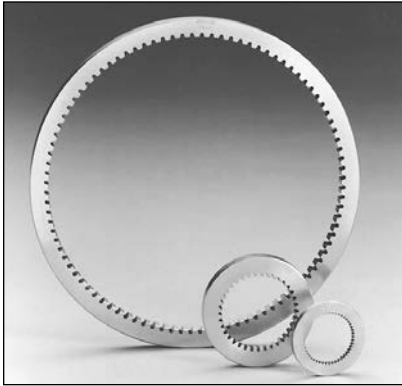

STANDARD TOLERANCES

DIMENSION		TOLERANCE	
I.D.	48 Pitch	All	+.004 - .000
	32 Pitch	All	+.005 - .000
	24 Pitch	All	+.006 - .000
	16 Pitch	All	+.008 - .000
O.D.	All		+.001 + .003

ALL DIMENSIONS IN INCHES
ORDER BY CATALOG NUMBER OR ITEM CODE

No. of Teeth	Pitch Dia.	O.D.	I.D.	Catalog Number	Item Code
48					
DIAMETRAL PITCH					
FACE = .125"					
48	1.000	1.500	.986	G632	12066
72	1.500	2.000	1.486	G633	12068
96	2.000	2.750	1.986	G635	12070
144	3.000	3.750	2.986	G637	12072
32					
DIAMETRAL PITCH					
FACE = .188"					
48	1.500	2.000	1.480	G664	12056
64	2.000	2.750	1.980	G666	12058
96	3.000	3.750	2.980	G668	12060
128	4.000	4.750	3.980	G669	12062
192	6.000	6.750	5.980	G670	12064
24					
DIAMETRAL PITCH					
FACE = .250"					
36	1.500	2.250	1.474	G675	12046
48	2.000	2.750	1.974	G677	12048
72	3.000	3.750	2.974	G679	12050
96	4.000	4.750	3.974	G680	12052
144	6.000	6.750	5.974	G681	12054
16					
DIAMETRAL PITCH					
FACE = .313"					
32	2.000	2.750	1.962	G689	12038
48	3.000	3.750	2.962	G691	12040
64	4.000	4.750	3.962	G692	12042
96	6.000	6.750	5.962	G693	12044

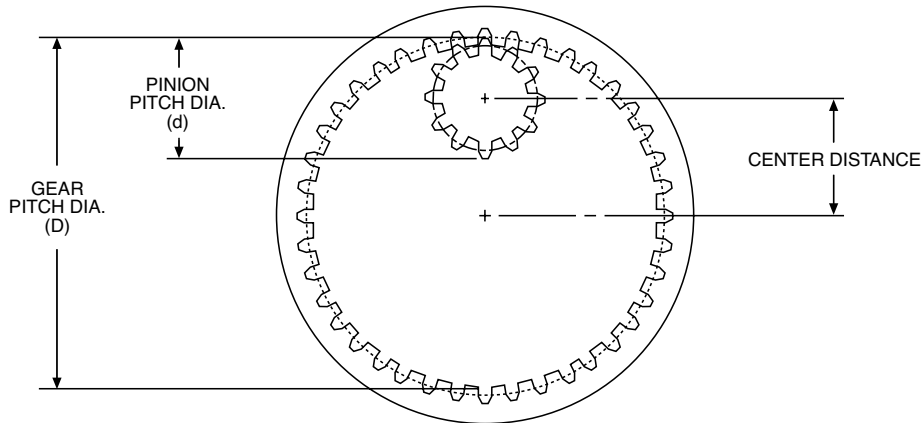

$$\text{CENTER DISTANCE} = \frac{D-d}{2}$$

NOTE: The difference in tooth numbers between Gear and Pinion should not be less than 15.

64 and 48 Diametral Pitch (Delrin & Brass)

20° Pressure Angle (will not operate with 14-1/2° spurs)

ALL DIMENSIONS IN INCHES
ORDER BY CATALOG NUMBER OR ITEM CODE

No. of Teeth	Pitch Dia.	Bore	Hub		Style See Page 323	Without Keyway or Setscrew	
			Dia.	Proj.		Catalog Number	Item Code
64 DIAMETRAL PITCH						Face = .125" Outside Dia. = Pitch Dia. + .033" Overall Length = .125" + Hub Proj.	
BRASS							
16	.250	.125	.19	.19	A	Y6416	09482
18	.281		.22			Y6418	09484
20	.312		.25			Y6420	09486
24	.375		.28			Y6424	09488
28	.438		.34			Y6428	09490
32	.500	.1875	.38	.25		Y6432	09492
36	.562		.44			Y6436	09494
40	.625		.44			Y6440	09496
44	.688		.50			Y6444	09498
48	.750		.50			Y6448	09500
52	.812		.56		Y6452	09502	
56	.875		.56		Y6456	09504	
60	.938	.62	Y6460	09506			
64	1.000	.250	.62	.25	Y6464	09508	
72	1.125		.69		Y6472	09510	
80	1.250		.69		Y6480	09512	
88	1.375		.75		Y6488	09514	
96	1.500		.75		Y6496	09516	
112	1.750		.81		Y64112	09518	
128	2.000		.88		Y64128	09520	
144	2.250		.3125		.75	.31	C
160	2.500	.75		Y64160	09524		
192	3.000	.88		Y64192	09526		
48 DIAMETRAL PITCH						Face = .125" Outside Dia. = Pitch Dia. + .042" Overall Length = .125" + Hub Proj.	
MOLDED DELRIN							
18	.375	.1562	.31	.25	A	YP4818	53902
19	.396		.34			YP4819	53903
20	.417		.34			YP4820	53904
21	.438		.34			YP4821	53905
22	.458		.38			YP4822	53906
23	.479		.38			YP4823	53907
24	.500		.41			YP4824	53908
25	.521		.41			YP4825	53909
26	.542		.45			YP4826	53910
27	.562		.45			YP4827	53911
28	.583	.48	YP4828	53912			
29	.604	.48	YP4829	53913			
30	.625	.50	YP4830	53914			
31	.646	.1875	.55	.25	YP4831	53915	
32	.667				YP4832	53916	
33	.688				YP4833	53917	
34	.708				YP4834	53918	
35	.729				YP4835	53919	
36	.750				YP4836	53920	
37	.771				YP4837	53921	
38	.792				YP4838	53922	
39	.813				YP4839	53923	
40	.833				YP4840	53924	
42	.875				YP4842	53925	

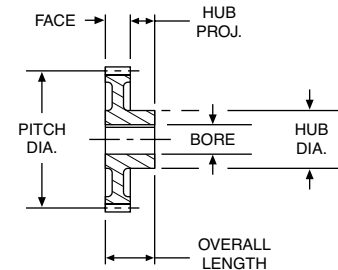
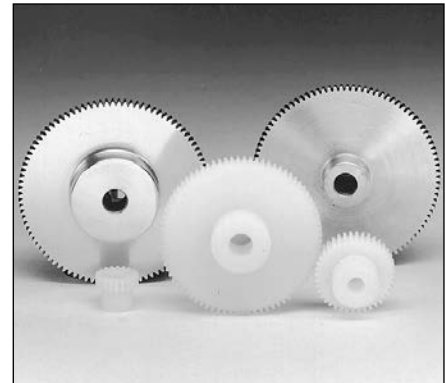

STANDARD TOLERANCES

DIMENSION		TOLERANCE
BORE	All	±.0005



48 D.P.



64 D.P.

REFERENCE PAGES

Alterations — 322
Lubrication — 322
Materials — 323

Spur Gears

48 Diametral Pitch (Delrin)

20° Pressure Angle (will not operate with 14-1/2° spurs)

A

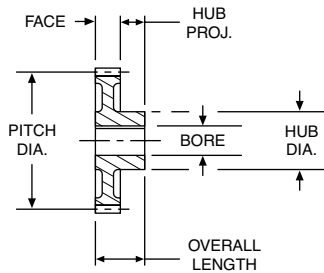
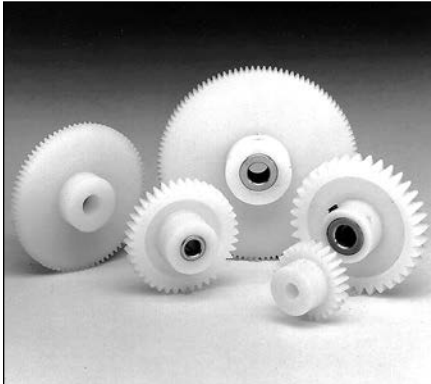

STANDARD TOLERANCES*

DIMENSION		TOLERANCE
BORE	All	+ .001 - .000

*Gears with Brass Inserts only.



REFERENCE PAGES

Alterations — 322
Materials — 323

†All YPB gears have setscrews.

BORE	SETSCREW
1/8	#2-56
3/16	#4-40
1/4	#6-32

ALL DIMENSIONS IN INCHES
ORDER BY CATALOG NUMBER OR ITEM CODE

No. of Teeth	Pitch Dia.	Bore	Hub		Style See Page 323	Without Keyway or Setscrew†					
			Dia.	Proj.		Catalog Number	Item Code				
48 DIAMETRAL PITCH						Face = .125" Outside Dia. = Pitch Dia. + .042" Overall Length = .125" + Hub Proj.					
MOLDED DELRIN											
44	.917	.188	.55			YP4844	53926				
45	.938					YP4845	53927				
48	1.000	.250	.61	.25	B	YP4848	53928				
52	1.083					YP4852	53929				
54	1.125					YP4854	53930				
56	1.168					YP4856	53931				
60	1.250					YP4860	53932				
64	1.333					YP4864	53933				
66	1.375					YP4866	53934				
72	1.500					YP4872	53935				
80	1.667					YP4880	53936				
84	1.750					YP4884	53937				
96	2.000					YP4896	53938				
100	2.083					YP48100	53939				
108	2.250	YP48108	53940								
120	2.500	YP48120	53941								
MOLDED DELRIN WITH BRASS INSERTS											
18	.375	.125	.31			YPB4818	53942				
19	.396					YPB4819	53943				
20	.417					YPB4820	53944				
21	.438					YPB4821	53945				
22	.458					YPB4822	53946				
23	.479					YPB4823	53947				
24	.500	.40				YPB4824	53948				
25	.521					YPB4825	53949				
26	.542					.188	.45			YPB4826	53950
27	.562	YPB4827	53951								
28	.583	.48								YPB4828	53952
29	.604									YPB4829	53953
30	.625	.50								YPB4830	53954
31	.646									YPB4831	53955
32	.667	.55	.25		A	YPB4832	53956				
33	.688					YPB4833	53957				
34	.708					YPB4834	53958				
35	.729					YPB4835	53959				
36	.750					YPB4836	53960				
37	.771					YPB4837	53961				
38	.792					YPB4838	53962				
39	.813					YPB4839	53963				
40	.833					YPB4840	53964				
42	.875					YPB4842	53965				
44	.917					YPB4844	53966				
45	.938					YPB4845	53967				
48	1.000	.250	.61		B	YPB4848	53968				
52	1.083					YPB4852	53969				
54	1.125					YPB4854	53970				
56	1.168					YPB4856	53971				
60	1.250					YPB4860	53972				
64	1.333					YPB4864	53973				
66	1.375					YPB4866	53974				
72	1.500					YPB4872	53975				
80	1.667					YPB4880	53976				
84	1.750					YPB4884	53977				
96	2.000					YPB4896	53978				
100	2.083					YPB48100	53979				
108	2.250	YPB48108	53980								
120	2.500	YPB48120	53981								

48 and 32 Diametral Pitch (Delrin & Brass)

20° Pressure Angle (will not operate with 14-1/2° spurs)

ALL DIMENSIONS IN INCHES
ORDER BY CATALOG NUMBER OR ITEM CODE

No. of Teeth	Pitch Dia.	Bore	Hub		Style See Page 323	Without Keyway or Setscrew	
			Dia.	Proj.		Catalog Number	Item Code
48 DIAMETRAL PITCH						Face = .125" Outside Dia. = Pitch Dia. + .042" Overall Length = .125" + Hub Proj.	
BRASS							
12	.250	.125	.18	.19	A	Y4812	09444
15	.312		.22			Y4815	09446
18	.375		.28			Y4818	09448
21	.438		.35			Y4821	09450
24	.500	.1875	.38	.25		Y4824	09452
27	.562		.44			Y4827	09454
30	.625		.44			Y4830	09456
36	.750		.50			Y4836	09458
42	.875		.57			Y4842	09460
48	1.000	.250	.63	.25		Y4848	09462
54	1.125		.69			Y4854	09464
60	1.250		.69			Y4860	09466
66	1.375		.75		Y4866	09468	
72	1.500		.75		Y4872	09470	
84	1.750		.82		Y4884	09472	
96	2.000		.88		Y4896	09474	
120	2.500		.3125		.75	.31	C
144	3.000	.88	.88	Y48144	09478		
192	4.000	1.00	1.00	Y48192	09480		
32 DIAMETRAL PITCH						Face = .188" Outside Dia. = Pitch Dia. + .062" Overall Length = .188" + Hub Proj.	
MOLDED DELRIN							
12	.375	.1562	.28	.31	A	YP3212	53982
14	.438		.31			YP3214	53983
15	.469		.31			YP3215	53984
16	.500		.34			YP3216	53985
18	.562		.34			YP3218	53986
20	.625	.1875	.47	.31		YP3220	53987
22	.688		.50			YP3222	53988
24	.750		.50			YP3224	53989
26	.812		.56			YP3226	53990
28	.875		.50			YP3228	53991
30	.938		.56			YP3230	53992
32	1.000	.250	.63	.31		B	YP3232
34	1.062		.61		YP3234		53994
36	1.125		.61		YP3236		53995
38	1.187		.61		YP3238		53996
40	1.250		.61		YP3240		53997
42	1.312		.63		YP3242		53998
44	1.375		.63		YP3244		53999
48	1.500		.63		YP3248		54000
52	1.625	.3125	.67	.31	YP3252		54001
56	1.750		.81		YP3256		54002
64	2.000		.81		YP3264		54003
72	2.250		.81		YP3272		54004
80	2.500		.81		YP3280	54005	
96	3.000		.81		YP3296	54006	

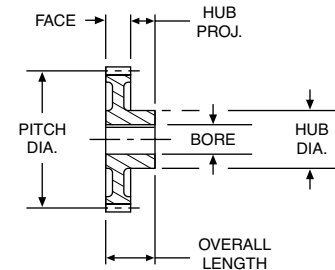
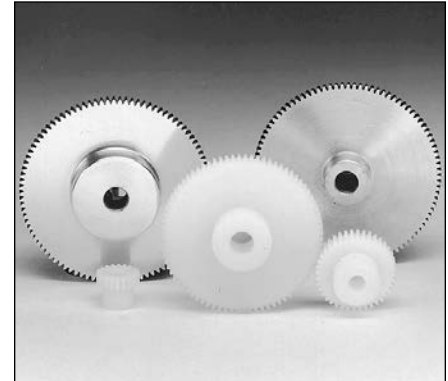

STANDARD TOLERANCES*

DIMENSION		TOLERANCE
BORE	All	±.0005"

*Brass only.



48 D.P.



32 D.P.

REFERENCE PAGES

Alterations — 322
Lubrication — 322
Materials — 323

Spur Gears

32 Diametral Pitch (Delrin & Brass)

20° Pressure Angle (will not operate with 14-1/2° spurs)

A

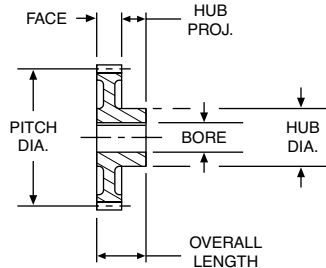
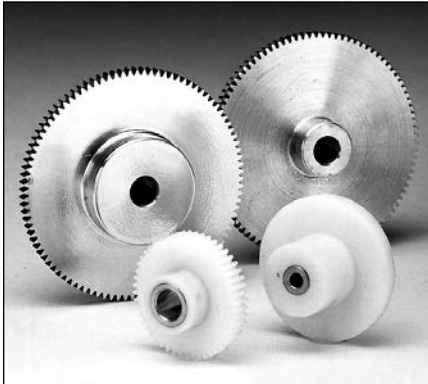

STANDARD TOLERANCES

DIMENSION		TOLERANCE
Brass		
BORE	All	± .0005
Delrin with Brass Inserts		
BORE	All	+ .001 - .000



32 D.P.

REFERENCE PAGES

Alterations — 322
 Lubrication — 322
 Materials — 323

†All YPB gears have setscrew and spot drill.

BORE	SETScrew
1/8	#2-56
3/16	#4-40
1/4	#6-32
5/16	#8-32

ALL DIMENSIONS IN INCHES
 ORDER BY CATALOG NUMBER OR ITEM CODE

No. of Teeth	Pitch Dia.	Bore	Hub		Style See Page 323	Without Keyway or Setscrew†			
			Dia.	Proj.		Catalog Number	Item Code		
32 DIAMETRAL PITCH						Face = .188" Outside Dia. = Pitch Dia. + .062" Overall Length = .188" + Hub Proj.			
MOLDED DELRIN with BRASS INSERTS									
12	.375	.125	.28	.31	A	YPB3212	54007		
14	.438		.31			YPB3214	54008		
15	.469		.31			YPB3215	54009		
16	.500		.34			YPB3216	54010		
18	.562		.34			YPB3218	54011		
20	.625		.1875			.47	YPB3220	54012	
22	.688	.50				YPB3222	54013		
24	.750	.50				YPB3224	54014		
26	.812	.56				YPB3226	54015		
28	.875	.50				YPB3228	54016		
30	.938	.56				YPB3230	54017		
32	1.000	.250	.63			B	YPB3232	54018	
34	1.062		.61				YPB3234	54019	
36	1.125		.61				YPB3236	54020	
38	1.187		.61				YPB3238	54021	
40	1.250		.61				YPB3240	54022	
42	1.312		.61				YPB3242	54023	
44	1.375	.61	YPB3244				54024		
48	1.500	.63	YPB3248	54025					
52	1.625	.3125	.67	C	YPB3252		54026		
56	1.750		.67		YPB3256		54027		
64	2.000		.67		YPB3264		54028		
72	2.250		.81		YPB3272		54029		
80	2.500		.81		YPB3280		54030		
96	3.000		.81		YPB3296		54031		
BRASS									
12	.375	.125	.28		.25		A	Y3212	09406
14	.438		.34					Y3214	09408
16	.500		.40					Y3216	09410
18	.562		.43			Y3218		09412	
20	.625		.47			Y3220		09414	
24	.750		.53			Y3224		09416	
28	.875	.59	Y3228			09418			
32	1.000	.250	.66			.25		Y3232	09420
36	1.125		.72					Y3236	09422
40	1.250		.72					Y3240	09424
48	1.500		.78					Y3248	09426
56	1.750		.84	Y3256				09428	
64	2.000		.90	Y3264				09430	
72	2.250	.88	Y3272	09432					
80	2.500	.88	Y3280	09434					
96	3.000	.3125	1.00	.31				Y3296	09436
112	3.500	1.00	Y32112					09438	
128	4.000	1.00	Y32128					09440	
160	5.000	1.00	Y32160		09442				

24 Diametral Pitch (Delrin)

20° Pressure Angle (will not operate with 14-1/2° spurs)

ALL DIMENSIONS IN INCHES
ORDER BY CATALOG NUMBER OR ITEM CODE

No. of Teeth	Pitch Dia.	Bore	Hub		Style See Page 323	Without Keyway or Setscrew†			
			Dia.	Proj.		Catalog Number	Item Code		
24 DIAMETRAL PITCH Face = .250" Outside Dia. = Pitch Dia. + .083" Overall Length = .250" + Hub Proj.									
MOLDED DELRIN									
12	.500	.188	.38	.31	A	YP2412	54032		
14	.583		.44			YP2414	54033		
15	.625		.48			YP2415	54034		
16	.667		.55			.31	A	YP2416	54035
17	.709							YP2417	54036
18	.750							YP2418	54037
19	.791							YP2419	54038
20	.833		.250			.31	B	YP2420	54039
21	.875							YP2421	54040
22	.917							YP2422	54041
23	.959	YP2423		54042					
24	1.000	.63		YP2424	54043				
25	1.041	.61		YP2425	54044				
26	1.083	.313	.67	B	YP2426	54045			
27	1.125				.63	YP2427	54046		
28	1.167				YP2428	54047			
30	1.250				YP2430	54048			
32	1.333				YP2432	54049			
33	1.375				.61	YP2433	54050		
34	1.416				YP2434	54051			
36	1.500				.63	YP2436	54052		
39	1.625	.313	.67	B	YP2439	54053			
40	1.666				YP2440	54054			
42	1.750				YP2442	54055			
44	1.833				YP2444	54056			
45	1.875				YP2445	54057			
48	2.000				YP2448	54058			
50	2.083				YP2450	54059			
52	2.166				YP2452	54060			
54	2.250				YP2454	54061			
56	2.333				YP2456	54062			
60	2.500	YP2460	54063						
MOLDED DELRIN WITH BRASS INSERTS									
12	.500	.188	.38	.31	A	YPB2412	54064		
14	.583		.44			YPB2414	54065		
15	.625		.48			YPB2415	54066		
16	.667		.55			.31	A	YPB2416	54067
17	.709							YPB2417	54068
18	.750							YPB2418	54069
19	.791							YPB2419	54070
20	.833		.250			.31	B	YPB2420	54071
21	.875							YPB2421	54072
22	.917							YPB2422	54073
23	.959	YPB2423		54074					
24	1.000	.63		YPB2424	54075				
25	1.041	.61		YPB2425	54076				
26	1.083	.313	.67	B	YPB2426	54077			
27	1.125				.63	YPB2427	54078		
28	1.167				YPB2428	54079			
30	1.250				YPB2430	54080			
32	1.333				YPB2432	54081			
33	1.375				.61	YPB2433	54082		
34	1.416				YPB2434	54083			
36	1.500				.63	YPB2436	54084		
39	1.625	.313	.67	B	YPB2439	54085			
40	1.666				YPB2440	54086			
42	1.750				YPB2442	54087			

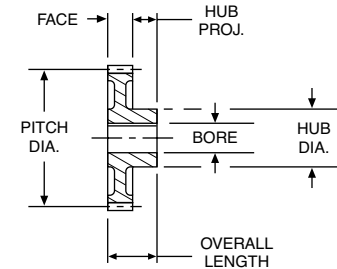
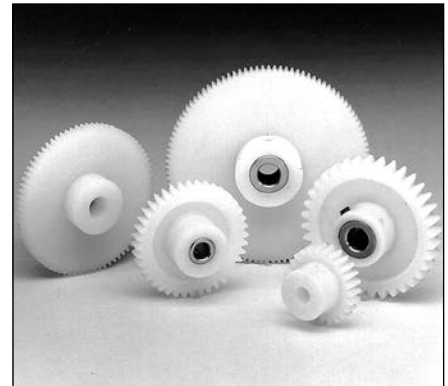

STANDARD TOLERANCES*

DIMENSION	TOLERANCE
BORE	All +.001 - .000

*Gears with Brass Inserts only.



24 D.P.

REFERENCE PAGES

Alterations — 322
Materials — 323

†All YPB gears have setscrew and spot drill.

BORE	SETSCREW
3/16	#4-40
1/4	#6-32
5/16	#8-32

Spur Gears

24 and 20 Diametral Pitch (Delrin, Brass, Steel & Cast Iron)

20° Pressure Angle (will not operate with 14-1/2° spurs)

A

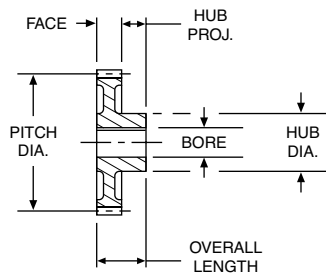
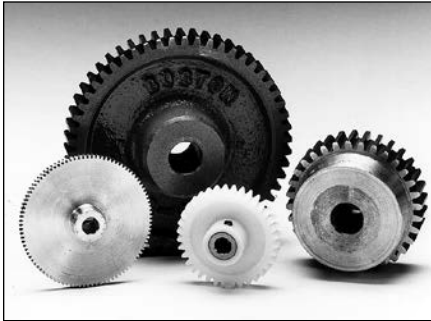

STANDARD TOLERANCES

DIMENSION		TOLERANCE
Brass, Steel and Cast Iron		
BORE	All	± .0005
Delrin with Brass Inserts		
BORE	All	+ .001 - .000



24 D.P.



20 D.P.

REFERENCE PAGES

- Alterations — 322
- Horsepower Ratings — 58
- Lubrication — 322
- Materials — 323
- Selection Procedure — 49

†YPB gears have one setscrew (#8-32), no keyway.

*5/16" bore have #35 (.110) drilled hole through one wall, no keyway.

‡3/8" bore have one setscrew. No keyway.

1/2" bore and larger have standard keyway at 90° to setscrew. See Page 323.

ALL DIMENSIONS IN INCHES
ORDER BY CATALOG NUMBER OR ITEM CODE

No. of Teeth	Pitch Dia.	Bore	Hub		Style See Page 323	Without Keyway or Setscrew		With Keyway and Setscrew†					
			Dia.	Proj.		Catalog Number	Item Code	Catalog Number	Item Code				
24 DIAMETRAL PITCH						Face = .250" Outside Dia. = Pitch Dia. + .083" Overall Length = .250" + Hub Proj.							
MOLDED DELRIN WITH BRASS INSERTS													
44	1.833	.3125	.67	.31	B	YPB2444	54088	-	-				
45	1.875					YPB2445	54089	-	-				
48	2.000					YPB2448	54090	-	-				
50	2.083					YPB2450	54091	-	-				
52	2.166					YPB2452	54092	-	-				
54	2.250					YPB2454	54093	-	-				
56	2.333					YPB2456	54094	-	-				
60	2.500					YPB2460	54095	-	-				
BRASS													
12	.500					.1875	.38	.25	A	Y2412	09372	-	-
15	.625	Y2415	09374	-	-								
18	.750	Y2418	09376	-	-								
21	.875	Y2421	09378	-	-								
24	1.000	Y2424	09380	-	-								
27	1.125	Y2427	09382	-	-								
30	1.250	Y2430	09384	-	-								
36	1.500	Y2436	09386	-	-								
42	1.750	.3125	.86	.25	C					Y2442	09388	-	-
48	2.000									Y2448	09390	-	-
54	2.250					Y2454	09392	-	-				
60	2.500					Y2460	09394	-	-				
72	3.000					Y2472	09396	-	-				
84	3.500					Y2484	09398	-	-				
96	4.000					Y2496	09400	-	-				
120	5.000					Y24120	09402	-	-				
144	6.000					Y24144	09404	-	-				
20 DIAMETRAL PITCH						Face = .500" Outside Dia. = Pitch Dia. + .100" Overall Length = .500" + Hub Proj.							
STEEL													
12	.600	.3125	.46	.44	A	YA12	09892	YA12-5/16"	46128				
14	.700					YA14	09894	YA14-5/16"	46129				
15	.750					YA15	09896	YA15-3/8"	46130				
16	.800					YA16	09898	YA16-3/8"	46131				
18	.900					YA18	09900	YA18-3/8"	46132				
20	1.000					YA20	09902	YA20-1/2	46133				
24	1.200					YA24	09914	YA24-1/2	46134				
25	1.250					YA25	09904	YA25-1/2	46135				
30	1.500					YA30	09906	YA30-1/2	46136				
35	1.750					YA35	09908	YA35-1/2	46137				
40	2.000	.500	.625	.50	A	YA40	09910	YA40-1/2	46138				
						-	-	YA40-5/8	46139				
						-	-	YA40-3/4	46140				
45	2.250					YA45	09912	-	-				
50	2.500					YA50A	10548	-	-				
60	3.000					YA60A	10550	-	-				
70	3.500					YA70A	10552	-	-				
CAST IRON													
80	4.000					.625	1.38	.62	C	YA80	10554	-	-
84	4.200									YA84	10556	-	-
90	4.500	YA90	10558	-	-								
100	5.000	YA100	10560	-	-								
120	6.000	YA120	10562	-	-								
140	7.000	YA140	10564	-	-								
160	8.000	YA160	10566	-	-								
180	9.000	YA180	10568	-	-								
200	10.000	YA200	10570	-	-								

16 and 12 Diametral Pitch (Steel & Cast Iron) 20° Pressure Angle (will not operate with 14-1/2° spurs)

ALL DIMENSIONS IN INCHES
ORDER BY CATALOG NUMBER OR ITEM CODE

No. of Teeth	Pitch Dia.	Bore	Hub		Style See Page 323	Without Keyway or Setscrew		With Keyway and Setscrew†	
			Dia.	Proj.		Catalog Number	Item Code	Catalog Number	Item Code
16 DIAMETRAL PITCH									
						Face = .750" Outside Dia. = Pitch Dia. + .125" Overall Length = .750" + Hub Proj.			
STEEL									
12	.750	.375	.56	.50	A	YB12	09916	YB12-3/8†	46141
14	.875	.375	.69	.50		YB14	09918	YB14-3/8†	46142
15	.938	.500	.75	.50		YB15	09920	YB15-3/8†	45991
						-	-	YB15-1/2	46143
16	1.000	.500	.81	.50		YB16	09922	YB16-1/2	46144
18	1.125	.500	.94	.50		YB18	09924	YB18-1/2	46145
20	1.250	.625	1.05	.50		YB20	09926	YB20-5/8	46146
24	1.500	.750	1.20	.50		YB24	09928	YB24-5/8	46147
						-	-	YB24-3/4	46148
28	1.750	.750	1.45	.50		YB28	09930	YB28-5/8	46149
						-	-	YB28-3/4	46150
30	1.875	.875	1.58	.50		YB30	09932	YB30-5/8	46151
						-	-	YB30-3/4	46152
						-	-	YB30-7/8	46153
32	2.000	1.000	1.70	.50		YB32	09934	YB32-5/8	46154
						-	-	YB32-3/4	46155
						-	-	YB32-7/8	46156
						-	-	YB32-1	46157
36	2.250	.625	1.95	.50		YB36	09936	-	-
40	2.500	.625	2.20	.50		YB40	09938	-	-
48	3.000	.625	2.00	.62	YB48A	10572	-	-	
56	3.500	.625	2.50	.62	YB56A	10574	-	-	
60	3.750	.625	2.75	.62	YB60A	10576	-	-	
64	4.000	.750	2.88	.75	YB64A	10578	-	-	
72	4.500	.750	3.38	.75	YB72A	10580	-	-	
80	5.000	.750	3.88	.75	YB80A	10582	-	-	
CAST IRON									
96	6.000	.750	1.75	.75	D	YB96	10584	-	-
128	8.000	.750	2.00	.75		YB128	10588	-	-
144	9.000	.750	2.00	.75		YB144	10590	-	-
160	10.000	.875	2.00	.75		YB160	10592	-	-
192	12.000	.875	2.00	1.00		YB192	10594	-	-
						-	-	-	-
						Face = 1.000" Outside Dia. = Pitch Dia. + .167" Overall Length = 1.000" + Hub Proj.			
12 DIAMETRAL PITCH									
STEEL									
12	1.000	.500	.75	.62	A	YD12	09940	YD12-1/2*	46158
13	1.083	.625	.83	.62		YD13	09942	YD13-5/8‡	46159
14	1.167	.625	.92	.62		YD14	09944	YD14-5/8	46160
15	1.250	.625	.99	.62		YD15	09946	YD15-5/8	46161
16	1.333	.625	1.07	.62		YD16	09948	YD16-5/8	46162
18	1.500	.750	1.24	.62		YD18	09950	YD18-3/4	46163
20	1.667	.750	1.32	.62		YD20	09952	YD20-3/4	46164
21	1.750	.875	1.40	.62		YD21	09954	YD21-3/4	46165
						-	-	YD21-7/8	46166
24	2.000	1.000	1.65	.62		YD24	09956	YD24-3/4	46167
						-	-	YD24-7/8	46168
						-	-	YD24-1	46169
28	2.333	1.000	1.99	.62		YD28	09958	YD28-3/4	46170
						-	-	YD28-7/8	46171
						-	-	YD28-1	46172
30	2.500	.750	2.15	.62		YD30	09960	-	-
36	3.000	.750	1.94	.88		YD36A	10596	-	-
42	3.500	.750	2.44	.88		YD42A	10598	-	-
48	4.000	.875	2.88	.88		YD48A	10600	-	-
54	4.500	.875	3.38	.88		YD54A	10602	-	-

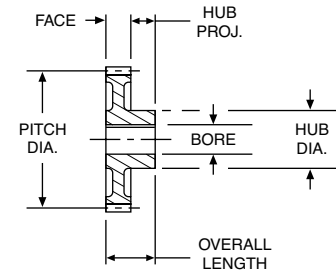

STANDARD TOLERANCES

DIMENSION	TOLERANCE
BORE	All ±.0005



16 D.P.



12 D.P.

REFERENCE PAGES

- Alterations — 322
- Horsepower Ratings — 58, 59
- Lubrication — 322
- Materials — 323
- Selection Procedure — 49

†3/8" bore have one setscrew.
No keyway.

YB15-1/2 and larger have standard keyway at 90° to setscrew.
See page 323.

*YD12-1/2 has one setscrew.
No keyway.

‡YD13-5/8 has one setscrew.
No keyway.

YD14-5/8 bore and larger have standard keyway at 90° to setscrew.

Spur Gears

12 and 10 Diametral Pitch (Cast Iron & Steel)

20° Pressure Angle (will not operate with 14-1/2° spurs)

A

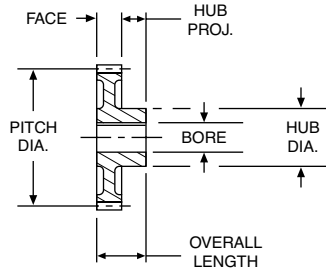

STANDARD TOLERANCES

DIMENSION		TOLERANCE
BORE	All	±.0005



12 D.P.



10 D.P.

ALL DIMENSIONS IN INCHES
ORDER BY CATALOG NUMBER OR ITEM CODE

No. of Teeth	Pitch Dia.	Bore	Hub		Style See Page 323	Without Keyway or Setscrew		With Keyway and Setscrew†	
			Dia.	Proj.		Catalog Number	Item Code	Catalog Number	Item Code
12 DIAMETRAL PITCH						Face = 1.000" Outside Dia. = Pitch Dia. + .166" Overall Length = 1.000" + Hub Proj.			
CAST IRON									
60	5.000	.875	2.12	.88	B	YD60	10604	-	-
66	5.500					YD66	10606	-	-
72	6.000					YD72	10608	-	-
84	7.000		YD84	10610		-	-		
96	8.000		YD96	10612		-	-		
108	9.000		2.25	YD108		10614	-	-	
120	10.000	1.000	2.25	.88	D	YD120	10616	-	-
132	11.000					YD132	10618	-	-
144	12.000					YD144	10620	-	-
168	14.000		YD168	10622		-	-		
192	16.000		YD192	10624		-	-		
216	18.000		2.75	YD216		10626	-	-	
10 DIAMETRAL PITCH						Face = 1.250" Outside Dia. = Pitch Dia. + .200" Overall Length = 1.250" + Hub Proj.			
STEEL									
12	1.200	.625	.92	.62	A	YF12	09962	YF12-5/8	46173
14	1.400		1.12	YF14		09964	YF14-5/8	46174	
15	1.500		1.22	YF15		09966	YF15-3/4	46175	
16	1.600		1.32	YF16		09968	YF16-3/4	46176	
18	1.800	.750	1.42	.62		YF18	09970	YF18-3/4	46177
		.875				-	-	YF18-7/8	46178
20	2.000	1.000	1.62	.62		YF20	09972	YF20-7/8	46179
						-	-	YF20-1	46180
24	2.400	.875	2.02	.62		YF24	09974	YF24-7/8	46181
		1.000				-	-	YF24-1	46182
25	2.500	.875	2.12	.62		YF25	09976	YF25-7/8	46183
		1.000				-	-	YF25-1	46184
28	2.800	.875	2.42	.62		YF28	09978	YF28-7/8	46185
		1.000				-	-	YF28-1	46186
30	3.000	.875	2.00	.88		YF30A	10630	-	-
35	3.500		2.50	YF35A		10632	-	-	
40	4.000	1.000	2.95	.88	YF40A	10634	-	-	
45	4.500		3.45	YF45A	10636	-	-		
48	4.800		3.75	YF48A	10638	-	-		
50	5.000		3.95	YF50A	10640	-	-		
CAST IRON									
55	5.500	1.000	2.50	1.00	B	YF55	10642	-	-
60	6.000					YF60	10644	-	-
70	7.000					YF70	10646	-	-
80	8.000					YF80	10648	-	-
90	9.000					YF90	10650	-	-
100	10.000	1.125	3.00	1.12	D	YF100	10652	-	-
120	12.000					YF120	10656	-	-
140	14.000					YF140	10658	-	-
160	16.000					YF160	10660	-	-
200	20.000					3.25	1.25	YF200B	10664

†All gears have standard keyway at 90° to setscrew. See Page 323.

REFERENCE PAGES

- Alterations — 322
- Horsepower Ratings — 59, 60
- Lubrication — 322
- Materials — 323
- Selection Procedure — 49

8 and 6 Diametral Pitch (Steel & Cast Iron)

20° Pressure Angle (will not operate with 14-1/2° spurs)

ALL DIMENSIONS IN INCHES
ORDER BY CATALOG NUMBER OR ITEM CODE

No. of Teeth	Pitch Dia.	Bore	Hub		Style See Page 323	Without Keyway or Setscrew		With Keyway and Setscrew†				
			Dia.	Proj.		Catalog Number	Item Code	Catalog Number	Item Code			
8 DIAMETRAL PITCH						Face = 1.500" Outside Dia. = Pitch Dia. + .250" Overall Length = 1.500" + Hub Proj.						
STEEL												
12	1.500	.750	1.12	.75	A	YH12	09980	YH12-3/4	46187			
14	1.750	.750	1.31	.75		YH14	09982	YH14-3/4	46188			
15	1.875	.875	1.43	.75		YH15	09984	YH15-3/4	46189			
						-	-	YH15-7/8	46190			
16	2.000	1.000	1.56	.88		YH16	09986	YH16-7/8	46191			
						-	-	YH16-1	46192			
18	2.250	.875	1.81	.88		YH18	09988	YH18-7/8	46193			
						-	-	YH18-1	46194			
						-	-	YH18-1-1/8	46195			
20	2.500	1.000	2.06	.88		YH20	09990	YH20-7/8	46196			
						-	-	YH20-1	46197			
						-	-	YH20-1-1/8	46198			
22	2.750	1.000	2.31	.88		YH22	09992	YH22-7/8	46199			
						-	-	YH22-1	46200			
						-	-	YH22-1-1/8	46201			
24	3.000	1.000	2.56	.88		YH24	09994	YH24-7/8	46202			
					-	-	YH24-1	46203				
					-	-	YH24-1-1/8	46204				
28	3.500	.875	3.06	.88	YH28	09996	-	-				
32	4.000	1.000	3.00	.88	YH32C	10666	-	-				
36	4.500	1.000	3.50	.88	YH36C	10668	-	-				
CAST IRON												
40	5.000	1.000	2.50	1.00	B	YH40B	10670	-	-			
44	5.500					YH44B	10672	-	-			
48	6.000					YH48B	10674	-	-			
56	7.000					YH56B	10676	-	-			
60	7.500				YH60	10678	-	-				
64	8.000				YH64B	10680	-	-				
72	9.000				YH72B	10682	-	-				
80	10.000				1.125	3.00	1.25	D	YH80B	10684	-	-
88	11.000	YH88B	10686	-					-			
96	12.000	YH96B	10688	-					-			
112	14.000	YH112B	10690	-					-			
120	15.000	YH120	10692	-				-				
128	16.000	YH128B	10694	-				-				
6 DIAMETRAL PITCH								Face = 2.000" Outside Dia. = Pitch Dia. + .333" Overall Length = 2.000" + Hub Proj.				
STEEL												
12	2.000	1.000	1.46	.88	A	YJ12	09998	YJ12-1	46205			
14	2.333	1.000	1.79	.88		YJ14	10000	YJ14-1	46206			
						-	-	YJ14-1-1/8	46207			
15	2.500	1.000	1.96	.88		YJ15	10002	YJ15-1	46208			
						-	-	YJ15-1-1/8	46209			
						-	-	YJ15-1-3/16	46210			
						-	-	YJ15-1-1/4	46211			

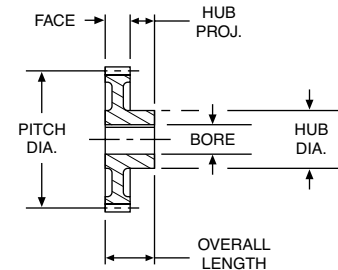

STANDARD TOLERANCES

DIMENSION	TOLERANCE
BORE	All ±.0005

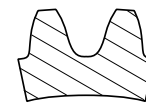

8 D.P.



6 D.P.

†All gears have standard keyway at 90° to setscrew. See Page 323.

REFERENCE PAGES

- Alterations — 322
- Horsepower Ratings — 60, 61
- Lubrication — 322
- Materials — 323
- Selection Procedure — 49

Spur Gears

6 and 5 Diametral Pitch (Steel & Cast Iron)

20° Pressure Angle (will not operate with 14-1/2° spur)

A

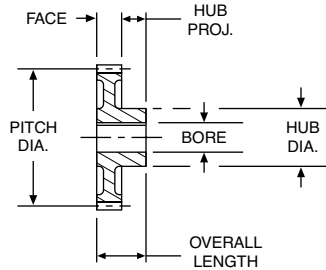

STANDARD TOLERANCES

DIMENSION		TOLERANCE
BORE	All	±.0005

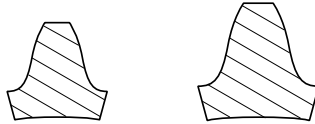

6 D.P.

5 D.P.

REFERENCE PAGES

- Alterations — 322
- Horsepower Ratings — 61, 62
- Lubrication — 322
- Materials — 323
- Selection Procedure — 49

ALL DIMENSIONS IN INCHES
ORDER BY CATALOG NUMBER OR ITEM CODE

No. of Teeth	Pitch Dia.	Bore	Hub		Style See Page 323	Without Keyway or Setscrew		With Keyway and Setscrew†		
			Dia.	Proj.		Catalog Number	Item Code	Catalog Number	Item Code	
6 DIAMETRAL PITCH						Face = 2.000" Outside Dia. = Pitch Dia. + .333" Overall Length = 2.000" + Hub Proj.				
STEEL										
16	2.667	1.000 1.125 1.1875 1.250	2.13	.88	A	YJ16	10004	YJ16-1	46212	
						-	-	YJ16-1-1/8	46213	
						-	-	YJ16-1-3/16	46214	
						-	-	YJ16-1-1/4	46215	
18	3.000	1.000 1.125 1.1875 1.250	2.46	.88		YJ18	10006	YJ18-1	46216	
						-	-	YJ18-1-1/8	46217	
						-	-	YJ18-1-3/16	46218	
						-	-	YJ18-1-1/4	46219	
21	3.500	1.000 1.125 1.1875 1.250	2.96	.88		YJ21	10008	YJ21-1	46220	
						-	-	YJ21-1-1/8	46221	
						-	-	YJ21-1-3/16	46222	
						-	-	YJ21-1-1/4	46223	
24	4.000		3.00			YJ24A	10704	-	-	
27	4.500	1.125	3.50	.88		YJ27A	10706	-	-	
30	5.000		4.00			YJ30C	10708	-	-	
CAST IRON										
33	5.500	1.125	3.00	1.50	B	YJ33B	10710	-	-	
36	6.000		3.50		A	YJ36B	10712	-	-	
42	7.000					YJ42B	10714	-	-	
48	8.000	1.250	3.50	1.50	B	YJ48B	10716	-	-	
54	9.000					YJ54B	10718	-	-	
60	10.000				C	YJ60B	10720	-	-	
66	11.000					YJ66B	10722	-	-	
72	12.000	1.250	4.00	1.50		YJ72B	10724	-	-	
84	14.000					YJ84B	10726	-	-	
96	16.000				D	YJ96B	10728	-	-	
108	18.000					YJ108B	10730	-	-	
120	20.000	1.375	4.50	1.50		YJ120B	10732	-	-	
5 DIAMETRAL PITCH						Face = 2.500" Outside Dia. = Pitch Dia. + .400" Overall Length = 2.500" + Hub Proj.				
STEEL										
12	2.400		1.78		A	YK12	10010	-	-	
14	2.800		2.18			YK14	10012	-	-	
15	3.000	1.125	2.38	.88		YK15	10014	-	-	
16	3.200		2.58			YK16	10016	-	-	
18	3.600		2.98			YK18	10018	-	-	
20	4.000		3.38			YK20	10020	-	-	
CAST IRON										
24	4.800	1.125	3.75	1.25		A	YK24	10738	-	-
25	5.000					YK25B	10740	-	-	
28	5.600					YK28	10742	-	-	
30	6.000					YK30B	10744	-	-	
35	7.000				B	YK35B	10746	-	-	
40	8.000	1.250	3.75	1.25		YK40B	10748	-	-	
45	9.000					YK45B	10750	-	-	
50	10.000		4.00		C	YK50B	10752	-	-	
60	12.000					YK60B	10754	-	-	
70	14.000	1.375	4.38	1.50		YK70B	10756	-	-	
80	16.000					YK80B	10758	-	-	
100	20.000	1.500	4.75	1.75	D	YK100B	10762	-	-	
110	22.000					YK110B	10764	-	-	
120	24.000		5.00			YK120B	10766	-	-	
140	28.000		5.00			YK140B	10768	-	-	
160	32.000	1.625	5.00	2.00		YK160B	10770	-	-	
180	36.000		5.50			YK180B	10772	-	-	

†All gears have standard keyway at 90° to setscrew. See Page 323.

20 through 4 Diametral Pitch (Steel)

20° Pressure Angle (will not operate with 14-1/2° spurs)

ALL DIMENSIONS IN INCHES
ORDER BY CATALOG NUMBER OR ITEM CODE

Overall Thickness	Pitch Line to Back (B)	Nominal Length (Feet)	Mating Spur Gear Page No.	Steel	
				Catalog Number	Item Code
20 DIAMETRAL PITCH					
FACE WIDTH - .500"					
.500	.450	4 6	42	L2020-4 L2020-6	12758 12760
16 DIAMETRAL PITCH					
FACE WIDTH - .750"					
.750	.688	4 6	43	L2016-4 L2016-6	12762 12764
12 DIAMETRAL PITCH					
FACE WIDTH - 1.000"					
1.000	.917	4 6	43 - 44	L2012-4 L2012-6	37320 37322
10 DIAMETRAL PITCH					
FACE WIDTH - 1.250"					
1.250	1.150	4 6	44	L2010-4 L2010-6	37316 37318
8 DIAMETRAL PITCH					
FACE WIDTH - 1.500"					
1.500	1.375	4 6	45	L208-4 L208-6	37312 37314
6 DIAMETRAL PITCH					
FACE WIDTH - 2.000"					
1.500	1.333	4 6	45 - 46	L206-4 L206-6	37308 37310
5 DIAMETRAL PITCH					
FACE WIDTH - 2.500"					
1.500	1.300	4 6	46	L205-4 L205-6	37304 37306
4 DIAMETRAL PITCH					
FACE WIDTH - 3.500"					
2.000	1.750	4 6	-	L204-4 L204-6	37300 37302

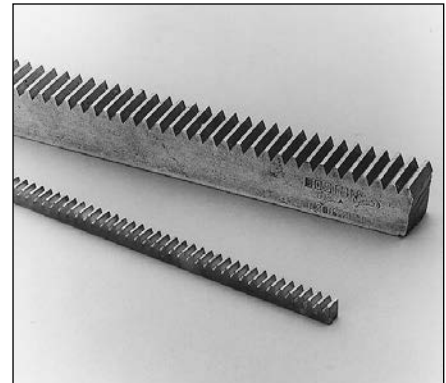

A

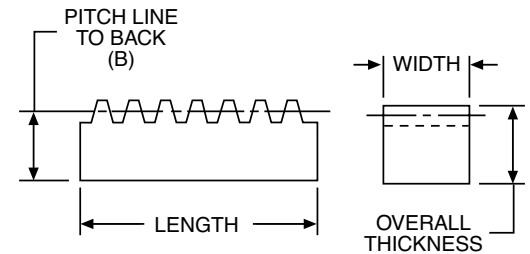

STANDARD TOLERANCES

DIMENSION	TOLERANCE
LENGTH†	All +1.000 - .000
FACE WIDTH	1/2 - 3/4 +.000 - .002
	1 - 1-1/2 +.000 - .003
	2 - 2-1/2 +.000 - .004
	3-1/2 +.000 - .006

†Ends not machined. Tolerance allows for cutting and matching.

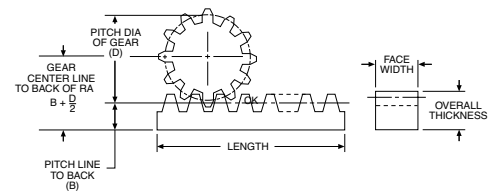

REFERENCE PAGES

Alterations — 322
Lubrication — 322
Materials — 323

Internal Gears

64 through 24 Diametral Pitch (Brass)

20° Pressure Angle (will not operate with 14-1/2° spurs)

A

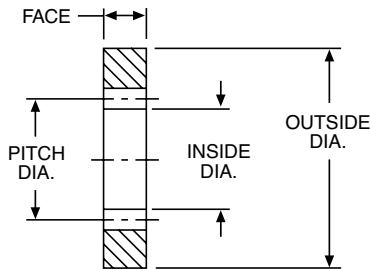
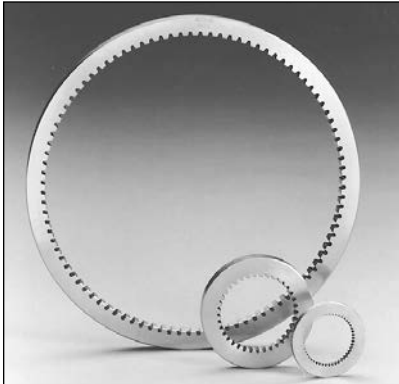

ALL DIMENSIONS IN INCHES
ORDER BY CATALOG NUMBER OR ITEM CODE

No. of Teeth	Pitch Dia.	O.D.	I.D.	Catalog Number	Item Code
64 DIAMETRAL PITCH			FACE WIDTH - .125"		
64	1.000	1.500	.980	YI6464	12030
96	1.500	2.000	1.480	YI6496	12032
128	2.000	2.750	1.980	YI64128	12034
192	3.000	3.750	2.980	YI64192	12036
48 DIAMETRAL PITCH			FACE WIDTH - .125"		
48	1.000	1.500	.974	YI4848	12020
72	1.500	2.000	1.474	YI4872	12022
96	2.000	2.750	1.974	YI4896	12024
144	3.000	3.750	2.974	YI48144	12026
192	4.000	4.750	3.974	YI48192	12028
32 DIAMETRAL PITCH			FACE WIDTH - .188"		
48	1.500	2.000	1.461	YI3248	12010
64	2.000	2.750	1.961	YI3264	12012
96	3.000	3.750	2.961	YI3296	12014
128	4.000	4.750	3.961	YI32128	12016
192	6.000	6.750	5.961	YI32192	12018
24 DIAMETRAL PITCH			FACE WIDTH - .250"		
36	1.500	2.250	1.450	YI2436	12000
48	2.000	2.750	1.950	YI2448	12002
72	3.000	3.750	2.950	YI2472	12004
96	4.000	4.750	3.950	YI2496	12006
144	6.000	6.750	5.950	YI24144	12008

NOTE: The difference in tooth numbers between Gear and Pinion should not be less than 12.

STANDARD TOLERANCES

DIMENSION		TOLERANCE	
I.D.	64 Pitch	All	+.004 - .000
	48 Pitch	All	+.005 - .000
	32 Pitch	All	+.006 - .000
	24 Pitch	All	+.008 - .000
O.D.	All		+.001 + .003

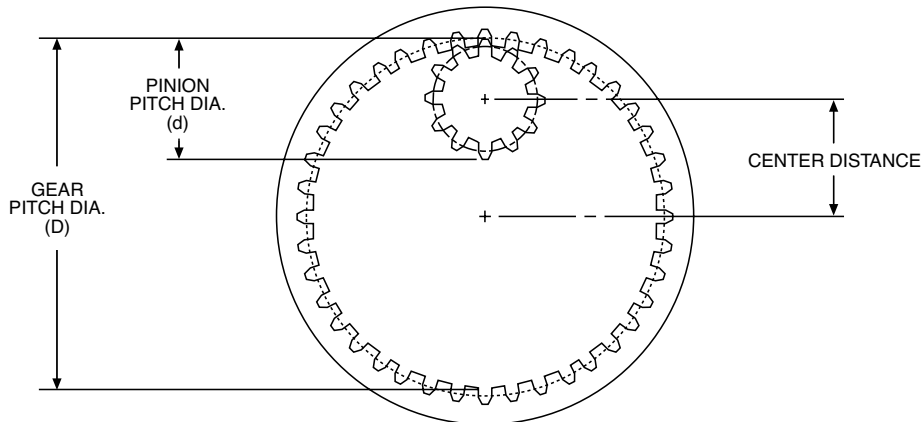

$$\text{CENTER DISTANCE} = \frac{D - d}{2}$$

Boston spur gears are designed to transmit motion or power between parallel shafts. Configurations include spur, rack, pinion wire, stem pinions and internal gears; most with a selection of bores, keyways and setscrews. Styles include plain, web, web with lightening holes or spoked. Change gears have consecutive numbers of teeth for reduction uses.

Boston fine-pitch spur gears are available in Delrin and Brass. Configurations include spur, rack, pinion wire and internal gears; most with a selection of bores, keyways, and setscrews. Styles include plain, web with lightening holes or spoked.

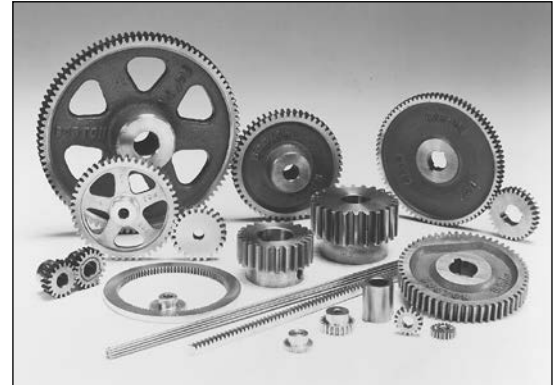

Selection Procedure

1. Determine service factor.
 - a. Using application Classification Chart, pages 331-332, determine service factor or
 - b. With knowledge of operating conditions and load classification, select service factor from Table 1 below.

Design HP = Application Load X Service Factor (Table 1)

3. Select spur gear pinion with horsepower capacity equal to (or greater than) design horsepower determined in Step 2. 14½° Pressure Angle Spur Gears—Page 50 to Page 57. 20° Pressure Angle Spur Gears— Page 58 to Page 62.
4. Select a driven spur gear with a catalog rating equal to or greater than the horsepower determined in Step 2. All ratings are predicated on gears properly lubricated and maintained.

Selection Hints

- A. Select pinion having pitch diameter at least twice the shaft diameter.
- B. Pinion number of teeth should be greater than 16 for 14½°PA and 13 for 20°PA to avoid excessive under-cutting.
- C. For tooth numbers or RPMs not on Chart, interpolation of horsepower is adequate.
- D. Pitchline velocities above 1000 FPM are not recommended for metallic spur gears. The Selection Chart reflects this in the lack of ratings for larger numbers of teeth at higher RPM's. Ratings to the right of heavy line are not recommended, as suggested maximum velocity is exceeded, and should be used for interpolation purposes only.

TABLE 1

Service Factor	Operating Conditions
.8	Uniform — not more than 15 minutes in 2 hours.
1.0	Moderate Shock — not more than 15 minutes in 2 hours. Uniform — not more than 10 hours per day.
1.25	Moderate Shock — not more than 10 hours per day. Uniform — more than 10 hours per day.
1.50	Heavy Shock — not more than 15 minutes in 2 hours. Moderate Shock — more than 10 hours per day.
1.75	Heavy Shock — not more than 10 hours per day.
2.0	Heavy Shock — more than 10 hours per day.

Heavy shock loads and/or severe wear conditions may require the use of higher service factors. Consultation with factory is recommended in these applications.

Spur Gears

Approximate Horsepower and Torque* Ratings

For Class I Service (Service Factor = 1.0)

32 DIAMETRAL PITCH STEEL

14½° PRESSURE ANGLE

3/16" FACE

REFERENCE PAGE 19.

No. Teeth	25 RPM		50 RPM		100 RPM		200 RPM		300 RPM		600 RPM		900 RPM		1200 RPM		1800 RPM		3600 RPM	
	H.P.	Torque	H.P.	Torque	H.P.	Torque	H.P.	Torque	H.P.	Torque	H.P.	Torque	H.P.	Torque	H.P.	Torque	H.P.	Torque	H.P.	Torque
16	.003	7.4	.01	7.3	.01	7.3	.02	7.1	.03	7.0	.06	6.6	.09	6.3	.11	5.9	.15	5.4	.24	4.2
18	.003	8.9	.01	8.8	.01	8.7	.03	8.5	.04	8.3	.07	7.8	.10	7.3	.13	6.9	.18	6.1	.27	4.7
20	.004	10.2	.01	10.2	.02	10.1	.03	9.8	.05	9.6	.08	8.9	.12	8.3	.15	7.8	.20	6.9	.30	5.2
22	.005	11.7	.01	11.6	.02	11.4	.04	11.1	.05	10.8	.09	9.9	.13	9.3	.16	8.7	.22	7.6	.32	5.7
24	.01	13.0	.01	12.9	.02	12.7	.04	12.3	.06	11.9	.10	10.9	.14	10.1	.18	9.4	.24	8.3	.34	6.0
26	.01	14.5	.01	14.4	.02	14.1	.04	13.7	.06	13.3	.12	12.0	.16	11.1	.20	10.2	.26	8.9	.37	6.4
28	.01	15.9	.01	15.1	.02	15.5	.05	14.9	.07	14.5	.12	13.1	.17	12.0	.21	11.0	.27	9.5	.39	6.8
30	.01	17.3	.01	17.0	.03	16.7	.05	16.1	.07	15.5	.13	13.9	.18	12.7	.22	11.7	.29	10.0	.40	7.0
32	.01	18.9	.01	18.7	.03	18.3	.06	17.6	.08	16.9	.14	15.2	.20	13.7	.24	12.6	.31	10.7	.43	7.4
40	.01	24.5	.02	24.2	.04	23.6	.07	22.4	.10	21.3	.18	18.7	.24	16.7	.29	15	.36	12.5	.48	8.4
48	.01	29.9	.02	29.4	.05	28.5	.09	26.8	.12	25.4	.21	21.8	.27	19.1	.32	17	.40	13.9	.52	9.0
56	.01	35.7	.03	35	.05	33.8	.10	31.5	.14	29.6	.24	24.9	.31	21.6	.36	18.9	.44	15.3	.55	9.7
64	.02	41.4	.03	40.6	.06	38.9	.11	36	.16	33.5	.26	27.8	.34	23.7	.39	20.7	.47	16.5	.58	10.2
80	.02	52.4	.04	51	.08	48.5	.14	44.2	.19	40.6	.31	32.5	.39	27.2	.44	23.3	.52	18.2		
96	.02	62.6	.05	60.6	.09	57.1	.16	51.2	.22	46.4	.34	36.2	.42	29.6	.48	25.1	.55	19.2		
128	.03	83.9	.06	80.6	.12	74.6	.21	64.9	.27	57.5	.41	42.7	.49	34	.54	28.3				
160	.04	106	.08	101	.15	92.1	.25	78.2	.32	67.8	.46	48.6	.54	37.9						
192	.05	126	.09	119	.17	107	.28	88.4	.36	75.4	.50	52.4	.57	40.1						

24 DIAMETRAL PITCH STEEL

14½° PRESSURE ANGLE

1/4" FACE

REFERENCE PAGE 20.

No. Teeth	25 RPM		50 RPM		100 RPM		200 RPM		300 RPM		600 RPM		900 RPM		1200 RPM		1800 RPM		3600 RPM	
	H.P.	Torque	H.P.	Torque	H.P.	Torque	H.P.	Torque	H.P.	Torque	H.P.	Torque	H.P.	Torque	H.P.	Torque	H.P.	Torque	H.P.	Torque
12	.004	10.9	.01	10.8	.02	10.7	.03	10.5	.05	10.3	.09	9.7	.13	9.2	.17	8.7	.22	7.9	.35	6.1
14	.01	14.2	.01	14.1	.02	13.9	.04	13.6	.06	13.3	.12	12.4	.17	11.6	.23	10.9	.28	9.8	.43	7.5
15	.01	15.8	.01	15.7	.02	15.5	.05	15.1	.07	14.7	.13	13.7	.18	12.8	.23	12	.31	10.7	.46	8.0
16	.01	17.5	.01	17.4	.03	17.2	.05	16.7	.08	16.2	.14	15	.20	14	.25	13.1	.33	11.6	.49	8.6
18	.01	20.9	.02	20.7	.03	20.4	.06	19.8	.09	19.2	.17	17.6	.23	16.3	.29	15.1	.38	13.3	.55	9.7
20	.01	24.3	.02	24.1	.04	23.7	.07	22.9	.11	22.1	.19	20.1	.26	18.5	.33	17.1	.42	14.8	.61	10.6
21	.01	26.1	.02	25.8	.04	25.4	.08	24.5	.11	23.6	.20	21.4	.28	19.6	.34	18.1	.45	15.6	.63	11.0
24	.01	30.7	.02	30.4	.05	29.7	.09	28.5	.13	27.5	.23	24.6	.32	22.3	.39	20.4	.50	17.4	.69	12.0
30	.02	40.7	.03	40.2	.06	39.2	.12	37.2	.17	35.5	.30	31.1	.40	27.7	.48	24.9	.60	20.8	.80	13.9
36	.02	51.2	.04	50.4	.08	48.8	.15	46	.21	43.5	.36	37.3	.47	32.7	.55	29.1	.68	23.9	.89	15.5
42	.02	60.7	.05	59.6	.09	59.5	.17	53.6	.24	50.3	.40	42.4	.52	36.6	.61	32.3	.74	26	.94	16.5
48	.03	70.4	.05	68.9	.11	66.2	.19	61.3	.27	57	.45	47.2	.58	40.3	.67	35.1	.80	28	.99	17.4
60	.04	90	.07	87.7	.13	83.3	.24	75.9	.33	69.6	.53	55.9	.67	46.6	.76	40	.89	31.2		
72	.04	109	.08	106	.16	99.8	.28	89.5	.39	81	.60	63.2	.74	51.8	.84	43.9	.96	33.6		
96	.06	147	.11	141	.21	130	.36	113	.48	100	.71	74.7	.85	59.5	.94	49.5				
120	.07	185	.14	175	.25	159	.43	135	.56	118	.80	84.3	.94	65.7	1.07	56.4				
144	.09	219	.16	207	.29	185	.49	153	.62	131	.86	90.8	.99	69.6						

Ratings are based on strength calculation. Basic static strength rating, or for hand operation of above gears is approximately 3 times the 100 RPM rating.

NOTE: Ratings to right of heavy line are not recommended, as pitch line velocity exceeds 1000 feet per minute. They should be used for interpolation purposes only.

* Torque Ratings (Lb. Ins.).

Ratings for brass gears are approximately 50% of steel ratings with same face width.

Approximate Horsepower and Torque* Ratings

For Class I Service (Service Factor = 1.0)

20 DIAMETRAL PITCH STEEL

14½° PRESSURE ANGLE

3/8" FACE

REFERENCE PAGE 20.

No. Teeth	25 RPM		50 RPM		100 RPM		200 RPM		300 RPM		600 RPM		900 RPM		1200 RPM		1800 RPM		3600 RPM	
	H.P.	Torque	H.P.	Torque	H.P.	Torque	H.P.	Torque	H.P.	Torque	H.P.	Torque	H.P.	Torque	H.P.	Torque	H.P.	Torque	H.P.	Torque
11	.01	21.6	.02	21.4	.03	21.2	.07	20.7	.10	20.2	.18	18.9	.25	17.8	.32	16.8	.43	15.1	.66	11.6
12	.01	23.5	.02	23.4	.04	23	.07	22.5	.10	21.9	.19	20.5	.27	19.2	.34	18	.46	16.1	.70	12.2
13	.01	26.9	.02	26.8	.04	26.4	.08	25.7	.12	25	.22	23.2	.31	21.6	.39	20.3	.51	17.9	.77	13.4
14	.01	30.7	.02	30.5	.05	30	.09	29.1	.13	28.3	.25	26.1	.35	24.2	.43	22.6	.57	20	.84	14.7
15	.01	34.2	.03	33.9	.05	33.4	.10	32.3	.15	31.4	.27	28.8	.38	26.6	.47	24.7	.62	21.7	.90	15.8
16	.02	37.8	.03	37.5	.06	36.8	.11	35.7	.16	34.5	.30	31.6	.41	29	.51	26.9	.67	23.4	.97	16.9
18	.02	45.1	.04	44.7	.07	43.8	.13	42.3	.19	40.8	.35	36.9	.48	33.7	.59	31	.76	26.7	1.08	18.9
20	.02	52.4	.04	51.9	.08	50.8	.15	48.7	.22	46.9	.40	42	.54	38	.66	34.8	.85	29.7	1.18	20.6
22	.02	59.5	.05	58.8	.09	57.5	.17	54.9	.25	52.7	.45	46.8	.60	42	.73	38.2	.92	32.3	1.26	22.1
24	.03	66.3	.05	65.4	.10	63.8	.19	60.8	.28	58	.49	51.1	.65	45.6	.78	41.2	.99	34.6	1.33	23.3
25	.03	70.5	.06	69.5	.11	67.7	.20	64.4	.29	61.4	.51	53.8	.68	47.9	.82	43.1	1.03	36	1.38	24.0
28	.03	81.2	.06	80	.12	77.7	.23	73.4	.33	69.7	.57	60.3	.76	53.2	.91	47.5	1.12	39.2	1.47	25.7
30	.03	87.8	.07	86.4	.13	83.7	.25	78.9	.36	74.6	.61	64	.80	56.1	.95	50	1.17	40.9	1.52	26.6
32	.04	96.3	.08	94.7	.15	91.6	.27	86	.39	81	.66	69.1	.86	60.2	1.02	53.3	1.24	43.4	1.59	27.8
35	.04	107	.08	105	.16	101	.30	94.7	.42	88.9	.71	74.9	.92	64.7	1.09	57	1.31	46	1.66	29.1
36	.04	110	.09	108	.17	104	.31	97.1	.43	91	.73	76.4	.94	65.8	1.10	57.8	1.33	46.5	1.68	29.3
40	.05	124	.10	122	.19	117	.34	108	.48	101	.79	83.5	1.02	71.2	1.18	62.1	1.41	49.4	1.75	30.7
48	.06	151	.12	148	.22	141	.41	128	.56	118	.91	95.4	1.14	80	1.31	69.8	1.54	53.8		
50	.06	158	.12	154	.23	146	.42	133	.58	122	.93	98	1.17	81.7	1.34	70.1	1.56	54.6		
60	.08	193	.15	187	.28	176	.50	158	.68	143	1.06	112	1.31	91.6	1.48	77.6	1.70	59.5		
64	.08	209	.16	203	.30	190	.54	169	.73	153	1.12	118	1.37	96	1.54	80.9				

A

20 DIAMETRAL PITCH CAST IRON

14½° PRESSURE ANGLE

3/8" FACE

REFERENCE PAGE 21.

No. Teeth	25 RPM		50 RPM		100 RPM		200 RPM		300 RPM		600 RPM		900 RPM		1200 RPM		1800 RPM		3600 RPM	
	H.P.	Torque	H.P.	Torque	H.P.	Torque	H.P.	Torque	H.P.	Torque	H.P.	Torque	H.P.	Torque	H.P.	Torque	H.P.	Torque	H.P.	Torque
70	.05	137	.10	132	.20	123	.35	109	.46	97.5	.71	74.2	.86	60	.96	50.2				
72	.06	140	.11	136	.20	126	.35	111	.47	99.4	.72	75.3	.87	60.6	.97	50.7				
80	.06	158	.12	152	.22	141	.39	123	.52	108	.77	80.7	.92	64.3	1.02	53.4				
84	.07	166	.13	159	.23	147	.40	127	.53	112	.79	82.7	.94	65.5	1.03	54.3				
90	.07	177	.13	169	.25	155	.42	133	.56	117	.81	85.4	.96	67.2						
96	.07	189	.14	180	.26	164	.44	140	.58	122	.84	87.9	.98	68.8						
100	.08	196	.15	186	.27	170	.46	144	.59	125	.85	89.5	1.00	69.7						
112	.09	222	.17	210	.30	189	.50	158	.65	136	.91	95.5	1.05	73.6						
120	.09	237	.18	223	.32	200	.53	166	.67	141	.93	98.1	1.07	75.1						
140	.11	273	.20	255	.36	225	.58	183	.73	153	.99	104								
144	.11	281	.21	262	.37	230	.59	186	.74	156	1.00	105								
160	.13	317	.23	294	.41	256	.64	203	.80	168	1.06	111								
180	.14	353	.26	324	.44	278	.69	217	.85	178	1.10	115								
200	.15	388	.28	354	.48	300	.73	230	.89	187	1.13	119								

Ratings are based on strength calculation. Basic static strength rating, or for hand operation of above gears is approximately 3 times the 100 RPM rating.

NOTE: Ratings to right of heavy line are not recommended, as pitch line velocity exceeds 1000 feet per minute. They should be used for interpolation purposes only.

*Torque Ratings (Lb. Ins.).

Spur Gears

Approximate Horsepower and Torque* Ratings

For Class I Service (Service Factor = 1.0)

16 DIAMETRAL PITCH STEEL 14½° PRESSURE ANGLE 1/2" FACE REFERENCE PAGE 21 & 22.

No. Teeth	25 RPM		50 RPM		100 RPM		200 RPM		300 RPM		600 RPM		900 RPM		1200 RPM		1800 RPM		3600 RPM	
	H.P.	Torque	H.P.	Torque	H.P.	Torque	H.P.	Torque	H.P.	Torque	H.P.	Torque	H.P.	Torque	H.P.	Torque	H.P.	Torque	H.P.	Torque
11	.02	44.9	.04	44.5	.07	43.9	.14	42.7	.20	41.5	.36	38.3	.51	35.6	.63	33.2	.84	29.4	1.24	21.7
12	.02	48.9	.04	48.5	.08	47.8	.15	46.3	.21	44.9	.39	41.2	.54	38.1	.67	35.4	.89	31	1.29	22.6
13	.02	56.1	.04	55.6	.09	54.7	.17	52.9	.24	51.2	.44	46.7	.61	42.9	.76	39.7	.99	34.6	1.42	24.9
14	.03	63.8	.05	63.2	.10	62	.19	59.8	.28	57.8	.50	52.4	.68	47.9	.84	44.2	1.09	38.2	1.55	27.1
15	.03	71.1	.06	70.3	.11	68.9	.21	66.4	.30	63.9	.55	57.6	.75	52.5	.92	48.1	1.18	41.3	1.66	29.0
16	.03	78.7	.06	77.8	.12	76.2	.23	73.1	.33	70.3	.60	63	.82	57.1	.99	52.2	1.27	44.5	1.77	30.9
18	.04	93.8	.07	99.6	.14	90.5	.27	86.5	.39	82.8	.70	73.4	.94	65.9	1.14	59.8	1.44	50.4	1.96	34.3
20	.04	109	.09	107	.17	105	.32	99	.45	94.9	.79	83.2	1.06	74.1	1.27	66.7	1.59	55.7	2.13	37.2
22	.05	124	.10	122	.19	118	.36	112	.51	106	.88	92.3	1.16	81.5	1.39	72.9	1.72	60.3	2.27	39.7
24	.05	138	.11	135	.21	131	.39	124	.56	117	.96	100	1.26	88	1.49	78.3	1.83	64.2	2.38	41.7
26	.06	154	.12	151	.23	146	.43	137	.61	129	1.04	110	1.36	95.4	1.61	84.4	1.96	68.6	2.51	43.9
28	.07	168	.13	165	.25	160	.47	149	.66	140	1.12	118	1.45	102	1.71	89.6	2.06	72.3	2.62	45.8
30	.07	182	.14	179	.27	172	.51	160	.71	149	1.19	125	1.53	107	1.79	93.8	2.15	75.1	2.69	47.1
32	.08	200	.16	196	.30	188	.55	174	.77	162	1.28	134	1.63	114	1.90	99.7	2.27	79.4	2.81	49.3
36	.09	228	.18	223	.34	213	.62	196	.86	181	1.40	147	1.77	124	2.05	107	2.42	84.6		
40	.10	258	.20	251	.38	239	.69	217	.95	200	1.52	160	1.91	134	2.18	115	2.55	89.4		
48	.12	314	.24	304	.45	286	.81	257	1.11	232	1.73	181	2.12	149	2.40	126	2.76	96.5		

16 DIAMETRAL PITCH CAST IRON 14½° PRESSURE ANGLE 1/2" FACE REFERENCE PAGE 22.

No. Teeth	25 RPM		50 RPM		100 RPM		200 RPM		300 RPM		600 RPM		900 RPM		1200 RPM		1800 RPM		3600 RPM	
	H.P.	Torque	H.P.	Torque	H.P.	Torque	H.P.	Torque	H.P.	Torque	H.P.	Torque	H.P.	Torque	H.P.	Torque	H.P.	Torque	H.P.	Torque
54	.09	217	.17	209	.31	196	.55	173	.74	156	1.13	119	1.38	96.6	1.54	81.1				
56	.09	224	.17	216	.32	202	.57	178	.76	160	1.16	121	1.40	98.1	1.57	82.2				
60	.10	239	.18	231	.34	214	.60	188	.80	167	1.20	126	1.44	100	1.60	84.2				
64	.10	260	.20	249	.37	231	.64	201	.85	178	1.26	132	1.50	105	1.67	87.5				
72	.12	290	.22	277	.40	255	.69	219	.91	192	1.33	140	1.57	110						
80	.13	327	.25	311	.45	283	.76	240	.99	208	1.42	149	1.66	116						
84	.14	342	.26	325	.47	294	.79	248	1.02	214	1.45	152	1.69	118						
96	.15	388	.29	365	.52	327	.86	271	1.10	231	1.53	161	1.76	123						
112	.18	455	.34	425	.60	376	.97	304	1.22	256	1.65	173								
120	.19	486	.36	452	.63	396	1.01	318	1.26	265	1.69	177								
128	.20	516	.38	477	.66	415	1.05	330	1.30	274	1.72	181								
144	.23	574	.42	527	.72	453	1.12	353	1.38	289	1.79	188								
160	.26	648	.47	590	.79	500	1.22	384	1.48	311	1.89	198								
192	.307	762	.54	683	.90	566	1.34	421	1.60	335										

16 DIAMETRAL PITCH NON-METALLIC 14½° PRESSURE ANGLE 1/2" FACE REFERENCE PAGE 22.

No. Teeth	25 RPM		50 RPM		100 RPM		200 RPM		300 RPM		600 RPM		900 RPM		1200 RPM		1800 RPM		3600 RPM	
	H.P.	Torque	H.P.	Torque	H.P.	Torque	H.P.	Torque	H.P.	Torque	H.P.	Torque	H.P.	Torque	H.P.	Torque	H.P.	Torque	H.P.	Torque
16							.06	19	.09	19	.15	16	.20	14	.25	13	.32	11	.56	9
20							.09	28	.12	30	.20	21	.26	18	.32	17	.42	15	.69	12
24							.11	34	.15	31	.24	25	.31	22	.38	20	.50	17	.82	14
32							.14	44	.19	40	.31	32	.40	28	.49	26	.65	23	1.12	20
40							.18	57	.24	50	.38	40	.49	34	.62	32	.82	29	1.41	25
48							.21	63	.28	58	.44	46	.60	40	.72	37	.96	33	1.65	29
64							.26	82	.34	71	.54	57	.72	50	.88	46	1.20	42		

Ratings are based on strength calculation. Basic static strength rating, or for hand operation of above gears is approximately 3 times the 100 RPM rating.

NOTE: 1. Ratings to right of heavy line are not recommended, as pitch line velocity exceeds 1000 feet per minute.

They should be used for interpolation purposes only.

2. Non-metallic gears are most commonly used for the driving pinion of a pair of gears, with mating gear made of Cast Iron or Steel, where pitch line velocities exceed 1000 FPM and are not subjected to shock loads.

*Torque Ratings (Lb. Ins.).

Approximate Horsepower and Torque* Ratings

For Class I Service (Service Factor = 1.0)

12 DIAMETRAL PITCH STEEL

14½° PRESSURE ANGLE

¾" FACE

REFERENCE PAGE 22.

No. Teeth	25 RPM		50 RPM		100 RPM		200 RPM		300 RPM		600 RPM		900 RPM		1200 RPM		1800 RPM		3600 RPM	
	H.P.	Torque	H.P.	Torque	H.P.	Torque	H.P.	Torque	H.P.	Torque	H.P.	Torque	H.P.	Torque	H.P.	Torque	H.P.	Torque	H.P.	Torque
11	.05	119	.09	118	.18	116	.35	112	.51	108	.93	97	1.27	88.6	1.55	81.5	2.00	70	2.82	49.4
12	.05	130	.10	129	.20	126	.38	120	.55	116	.99	104	1.35	94.4	1.64	86.3	2.10	73.6	2.92	51.1
13	.06	149	.12	147	.23	144	.44	138	.63	132	1.12	118	1.51	106	1.83	96.3	2.33	81.6	3.19	55.9
14	.07	169	.13	167	.26	163	.49	156	.71	149	1.25	131	1.68	118	2.03	107	2.56	89.6	3.46	60.6
15	.07	189	.15	186	.29	181	.55	172	.78	164	1.37	144	1.83	128	2.20	116	2.76	96.6	3.69	64.6
16	.08	209	.16	206	.32	200	.60	190	.86	180	1.50	157	1.99	139	2.38	125	2.96	103	3.91	68.5
18	.10	249	.19	245	.38	237	.71	224	1.01	242	1.73	182	2.28	159	2.70	142	3.32	116	4.31	75.4
20	.11	289	.23	284	.44	274	.82	257	1.15	215	1.95	205	2.54	178	2.99	157	3.64	127	4.65	81.4
21	.12	310	.24	304	.47	293	.87	274	1.22	257	2.06	216	2.67	187	3.14	164	3.80	133	4.81	84.3
22	.13	328	.26	322	.49	310	.92	288	1.28	270	2.15	226	2.78	195	3.25	171	3.92	137	4.93	86.2
24	.14	365	.28	357	.54	343	1.01	317	1.41	296	2.33	245	2.98	209	3.47	182	4.14	145	5.14	90.0
30	.19	483	.37	470	.71	447	1.29	407	1.78	373	2.85	299	3.57	250	4.09	215	4.78	167		
32	.21	529	.41	514	.77	488	1.40	442	1.92	403	3.05	320	3.80	266	4.32	227	5.02	176		
36	.24	605	.46	586	.88	552	1.57	495	2.13	448	3.33	349	4.09	286	4.62	243	5.31	186		
40	.27	682	.52	659	.98	617	1.74	547	2.34	492	3.59	377	4.37	306	4.90	257				
42	.28	715	.55	689	1.02	644	1.80	568	2.42	509	3.69	387	4.46	312	4.99	262				

A

12 DIAMETRAL PITCH CAST IRON

14½° PRESSURE ANGLE

¾" FACE

REFERENCE PAGE 23.

No. Teeth	25 RPM		50 RPM		100 RPM		200 RPM		300 RPM		600 RPM		900 RPM		1200 RPM		1800 RPM		3600 RPM	
	H.P.	Torque	H.P.	Torque	H.P.	Torque	H.P.	Torque	H.P.	Torque	H.P.	Torque	H.P.	Torque	H.P.	Torque	H.P.	Torque	H.P.	Torque
48	.20	497	.38	477	.70	441	1.22	384	1.62	340	2.41	253	2.88	201	3.19	167				
54	.23	571	.43	545	.79	500	1.36	430	1.79	377	2.62	275	3.09	216	3.40	178				
60	.25	631	.48	600	.87	546	1.47	463	1.91	402	2.74	288	3.21	224						
64	.27	683	.51	647	.93	586	1.56	493	2.02	425	2.87	301	3.33	233						
72	.30	762	.57	718	1.02	644	1.69	533	2.17	455	3.01	316	3.46	242						
84	.36	896	.66	837	1.17	739	1.90	598	2.40	503	3.24	340								
96	.40	1014	.74	938	1.30	817	2.06	649	2.56	538	3.39	356								
108	.46	1148	.84	1054	1.44	906	2.24	706	2.76	579	3.58	376								
112	.47	1187	.86	1087	1.47	929	2.29	720	2.80	588	3.62	379								
120	.50	1264	.91	1150	1.55	975	2.37	748	2.89	607	3.69	387								
144	.59	1487	1.06	1333	1.75	1103	2.61	821	3.11	654	3.86	406								
168	.69	1745	1.22	1541	1.98	1248	2.87	905	3.38	710										

12 DIAMETRAL PITCH NON-METALLIC

14½° PRESSURE ANGLE

¾" FACE

REFERENCE PAGE 23.

No. Teeth	25 RPM		50 RPM		100 RPM		200 RPM		300 RPM		600 RPM		900 RPM		1200 RPM		1800 RPM		3600 RPM	
	H.P.	Torque	H.P.	Torque	H.P.	Torque	H.P.	Torque	H.P.	Torque	H.P.	Torque	H.P.	Torque	H.P.	Torque	H.P.	Torque	H.P.	Torque
15							.13	41	.20	42	.34	36	.45	31	.56	29	.72	25	1.15	20
18							.19	60	.26	54	.43	45	.56	39	.68	36	.90	31	1.44	25
21							.23	72	.31	65	.50	52	.66	46	.81	42	1.06	37	1.80	31
24							.27	85	.36	76	.58	60	.76	53	.92	48	1.22	42	2.07	36
30							.34	107	.44	92	.73	76	.95	66	1.14	60	1.56	54	2.64	46
36							.40	126	.52	109	.82	86	1.13	79	1.36	71	1.83	64	3.18	56
48							.51	161	.66	138	1.05	110	1.39	97	1.70	89	2.33	81		
60							.60	189	.80	168	1.29	135	1.72	120	2.13	112	2.95	103		

Ratings are based on strength calculation. Basic static strength rating, or for hand operation of above gears is approximately 3 times the 100 RPM rating.

NOTE: 1. Ratings to right of heavy line are not recommended, as pitch line velocity exceeds 1000 feet per minute. They should be used for interpolation purposes only.

2. Non-metallic gears are most commonly used for the driving pinion of a pair of gears, with mating gear made of Cast Iron or Steel, where pitch line velocities exceed 1000 FPM and are not subjected to shock loads.

*Torque Ratings (Lb. Ins.).

Spur Gears

Approximate Horsepower and Torque* Ratings

For Class I Service (Service Factor = 1.0)

10 DIAMETRAL PITCH STEEL

14½° PRESSURE ANGLE

1" FACE

REFERENCE PAGE 23.

No. Teeth	25 RPM		50 RPM		100 RPM		200 RPM		300 RPM		600 RPM		900 RPM		1200 RPM		1800 RPM		3600 RPM	
	H.P.	Torque	H.P.	Torque	H.P.	Torque	H.P.	Torque	H.P.	Torque	H.P.	Torque	H.P.	Torque	H.P.	Torque	H.P.	Torque	H.P.	Torque
11	.09	229	.18	226	.35	221	.67	211	.96	202	1.71	179	2.31	162	2.80	147	3.55	124	4.85	85
12	.10	249	.20	246	.38	240	.73	229	1.04	218	1.83	192	2.45	172	2.95	155	3.71	130	5.00	88
14	.13	325	.25	320	.49	311	.93	294	1.33	279	2.30	241	3.04	213	3.62	190	4.49	157	5.89	103
15	.14	362	.28	356	.55	345	1.03	325	1.46	307	2.51	264	3.30	231	3.92	206	4.82	169	6.25	109
16	.16	400	.31	393	.60	381	1.13	357	1.60	337	2.73	287	3.57	250	4.22	221	5.15	180	6.62	116
18	.19	447	.37	468	.72	451	1.33	420	1.87	394	3.15	330	4.07	285	4.76	250	5.75	201	7.25	127
20	.22	553	.43	542	.83	520	1.53	481	2.13	448	3.53	371	4.52	317	5.26	276	6.28	220	7.79	136
24	.28	698	.54	681	1.03	648	1.88	592	2.59	545	4.19	440	5.26	369	6.04	317	7.09	248		
25	.29	742	.57	722	1.09	687	1.98	625	2.73	574	4.38	460	5.49	384	6.28	330	7.34	257		
28	.34	854	.66	829	1.24	784	2.24	707	3.06	644	4.83	507	5.98	419	6.79	357	7.85	275		
30	.37	922	.71	893	1.34	842	2.39	754	3.25	683	5.07	533	6.24	437	7.05	370	8.10	283		
32	.40	1010	.78	977	1.46	917	2.59	817	3.51	737	5.41	569	6.61	463	7.44	391				
35	.45	1123	.86	1083	1.60	1011	2.83	893	3.80	799	5.79	608	7.01	491	7.83	411				
36	.46	1153	.88	1111	1.64	1036	2.89	912	3.88	815	5.87	617	7.09	496	7.91	415				

10 DIAMETRAL PITCH CAST IRON

14½° PRESSURE ANGLE

1" FACE

REFERENCE PAGE 24.

No. Teeth	25 RPM		50 RPM		100 RPM		200 RPM		300 RPM		600 RPM		900 RPM		1200 RPM		1800 RPM		3600 RPM	
	H.P.	Torque	H.P.	Torque	H.P.	Torque	H.P.	Torque	H.P.	Torque	H.P.	Torque	H.P.	Torque	H.P.	Torque	H.P.	Torque	H.P.	Torque
40	.31	780	.59	749	1.10	693	1.92	603	2.54	534	3.79	398	4.52	317	5.01	263				
42	.32	818	.62	783	1.15	722	1.99	626	2.63	552	3.88	407	4.61	323	5.09	267				
45	.35	889	.67	850	1.24	780	2.13	670	2.79	587	4.08	428	4.81	337						
48	.38	946	.71	901	1.31	823	2.23	701	2.91	611	4.20	441	4.92	345						
50	.39	983	.74	935	1.35	851	2.29	722	2.98	626	4.27	449	4.99	350						
54	.43	1083	.82	1029	1.48	931	2.48	782	3.21	674	4.53	476	5.26	368						
55	.44	1105	.83	1046	1.50	945	2.51	791	3.24	681	4.57	480	5.29	371						
60	.48	1199	.90	1130	1.61	1013	2.66	839	3.41	716	4.73	497	5.43	381						
64	.51	1297	.97	1217	1.72	1084	2.82	890	3.59	755	4.93	518								
70	.56	1410	1.04	1316	1.84	1162	2.99	942	3.77	792	5.10	535								
72	.57	1447	1.07	1349	1.88	1187	3.04	958	3.82	803	5.15	541								
80	.64	1623	1.19	1502	2.07	1308	3.30	1039	4.10	861	5.43	570								
84	.67	1697	1.24	1565	2.15	1355	3.39	1069	4.10	882	5.51	579								
90	.72	1807	1.32	1659	2.26	1425	3.53	1111	4.34	911	5.63	591								
96	.76	1916	1.39	1750	2.37	1492	3.65	1152	4.46	938	5.73	602								
100	.79	1988	1.44	1810	2.44	1535	3.74	1177	4.54	955	5.80	609								
110	.87	2203	1.58	1990	2.64	1667	3.99	1258	4.81	1011	6.05	636								
120	.94	2380	1.69	2133	2.80	1766	4.17	1314	4.98	1047	6.18	650								
140	1.08	2724	1.91	2405	3.09	1949	4.48	1413	5.27	1108										
144	1.11	2791	1.95	2457	3.15	1983	4.54	1430	5.33	1119										
160	1.24	3132	2.16	2727	3.44	2166	4.87	1535	5.66	1188										
180	1.37	3459	2.36	2971	3.68	2318	5.11	1609	5.87	1233										

10 DIAMETRAL PITCH NON-METALLIC

14½° PRESSURE ANGLE

1" FACE

REFERENCE PAGE 23.

No. Teeth	25 RPM		50 RPM		100 RPM		200 RPM		300 RPM		600 RPM		900 RPM		1200 RPM		1800 RPM		3600 RPM	
	H.P.	Torque	H.P.	Torque	H.P.	Torque	H.P.	Torque	H.P.	Torque	H.P.	Torque	H.P.	Torque	H.P.	Torque	H.P.	Torque	H.P.	Torque
15							.27	85	.38	80	.63	66	.83	58	1.00	52	1.31	46	2.08	36
18							.33	104	.47	99	.78	82	1.02	71	1.24	65	1.63	57	2.60	45
20							.40	126	.54	113	.88	92	1.15	80	1.39	73	1.85	65	3.12	55
25							.51	161	.67	140	1.09	114	1.42	99	1.73	90	2.32	81	4.00	70
30							.62	195	.81	170	1.29	135	1.69	118	2.07	109	2.80	98	4.89	86

Ratings are based on strength calculation. Basic static strength rating, or for hand operation of above gears is approximately 3 times the 100 RPM rating.

NOTE: 1. Ratings to right of heavy line are not recommended, as pitch line velocity exceeds 1000 feet per minute.

They should be used for interpolation purposes only.

2. Non-metallic gears are most commonly used for the driving pinion of a pair of gears, with mating gear made of Cast Iron or Steel, where pitch line velocities exceed 1000 FPM and are not subjected to shock loads.

*Torque Ratings (Lb. Ins.).

Approximate Horsepower and Torque* Ratings For Class I Service (Service Factor = 1.0)

8 DIAMETRAL PITCH STEEL 14 1/2° PRESSURE ANGLE 1-1/4" FACE REFERENCE PAGE 24.

No. Teeth	25 RPM		50 RPM		100 RPM		200 RPM		300 RPM		600 RPM		900 RPM		1200 RPM		1800 RPM		3600 RPM	
	H.P.	Torque	H.P.	Torque	H.P.	Torque	H.P.	Torque	H.P.	Torque	H.P.	Torque	H.P.	Torque	H.P.	Torque	H.P.	Torque	H.P.	Torque
11	.18	446	.35	439	.68	427	1.28	404	1.82	383	3.16	332	4.19	294	5.00	263	6.21	217	8.17	143
12	.19	485	.38	478	.73	463	1.38	436	1.96	412	3.37	354	4.43	310	5.26	276	6.47	226	8.39	147
14	.25	632	.49	620	.95	599	1.77	559	2.49	524	4.21	442	5.45	382	6.40	336	7.75	271	9.81	172
15	.28	703	.55	690	1.05	664	1.96	617	2.74	576	4.58	481	5.90	413	6.89	362	8.29	290	10.39	182
16	.31	778	.60	762	1.16	731	2.15	677	3.00	630	4.97	522	6.36	445	7.39	388	8.83	309	10.96	192
18	.37	927	.72	905	1.37	865	2.52	794	3.49	734	5.69	598	7.20	504	8.30	436	9.80	343		
20	.43	1075	.83	1047	1.58	996	2.88	907	3.96	832	6.35	667	7.96	557	9.10	478	10.64	372		
22	.48	1219	.94	1184	1.78	1121	3.21	1012	4.39	923	6.95	730	8.62	603	9.79	514	11.34	397		
24	.54	1355	1.04	1313	1.96	1237	3.52	1109	4.78	1004	7.46	783	9.17	642	10.36	544	11.90	417		
28	.66	1655	1.27	1596	2.37	1490	4.18	1316	5.61	1178	8.53	896	10.33	723	11.54	606				
30	.71	1786	1.36	1718	2.53	1598	4.44	1400	5.93	1247	8.93	938	10.73	752	11.94	627				
32	.78	1957	1.49	1878	2.76	1738	4.80	1513	6.38	1340	9.49	997	11.34	794	12.56	660				

8 DIAMETRAL PITCH CAST IRON 14 1/2° PRESSURE ANGLE 1-1/4" FACE REFERENCE PAGE 25.

No. Teeth	25 RPM		50 RPM		100 RPM		200 RPM		300 RPM		600 RPM		900 RPM		1200 RPM		1800 RPM		3600 RPM	
	H.P.	Torque	H.P.	Torque	H.P.	Torque	H.P.	Torque	H.P.	Torque	H.P.	Torque	H.P.	Torque	H.P.	Torque	H.P.	Torque	H.P.	Torque
36	.53	1339	1.01	1279	1.86	1174	3.20	1009	4.21	884	6.14	645	7.25	507						
40	.60	1508	1.14	1434	2.07	1305	3.51	1107	4.57	961	6.55	688	7.66	536						
42	.63	1579	1.19	1498	2.16	1358	3.63	1145	4.71	989	6.69	703	7.78	545						
44	.67	1681	1.26	1591	2.28	1437	3.82	1204	4.93	1036	6.95	730	8.05	564						
48	.72	1824	1.36	1719	2.44	1540	4.05	1275	5.18	1088	7.19	756	8.27	579						
54	.83	2092	1.55	1958	2.75	1735	4.48	1413	5.67	1192	7.72	811								
56	.86	2164	1.60	2021	2.83	1784	4.59	1446	5.78	1215	7.83	822								
60	.92	2307	1.70	2145	2.98	1880	4.79	1508	5.99	1259	8.01	842								
64	.99	2492	1.83	2307	3.19	2008	5.06	1595	6.30	1323	8.33	875								
72	1.10	2775	2.02	2548	3.47	2188	5.42	1707	6.66	1399	8.64	908								
80	1.23	3107	2.24	2828	3.81	2398	5.84	1839	7.10	1492	9.06	952								
84	1.29	3246	2.34	2943	3.94	2481	5.99	1887	7.25	1523	9.18	965								
88	1.34	3384	2.42	3056	4.06	2561	6.13	1933	7.39	1553	9.30	976								
96	1.45	3656	2.60	3277	4.31	2713	6.41	2019	7.65	1608	9.50	998								
112	1.69	4256	2.98	3757	4.83	3045	7.01	2207	8.24	1731										
120	1.79	4517	3.14	3960	5.04	3176	7.22	2275	8.44	1773										
128	1.89	4773	3.30	4155	5.24	3300	7.42	2339	8.62	1811										
144	2.09	5272	3.59	4528	5.60	3532	7.78	2452												
160	2.33	5868	3.95	4980	6.07	3828	8.28	2610												

8 DIAMETRAL PITCH NON-METALLIC 14 1/2° PRESSURE ANGLE 1-1/4" FACE REFERENCE PAGE 24.

No. Teeth	25 RPM		50 RPM		100 RPM		200 RPM		300 RPM		600 RPM		900 RPM		1200 RPM		1800 RPM		3600 RPM	
	H.P.	Torque	H.P.	Torque	H.P.	Torque	H.P.	Torque	H.P.	Torque	H.P.	Torque	H.P.	Torque	H.P.	Torque	H.P.	Torque	H.P.	Torque
16							.56	176	.76	160	1.23	129	1.61	112	1.96	103	2.60	91	4.39	77
18							.61	192	.88	185	1.41	148	1.84	129	2.25	118	3.00	105	4.71	82
20							.74	233	.99	208	1.59	167	2.08	146	2.54	133	3.40	119	5.84	102
24							.90	283	1.19	250	1.90	200	2.50	175	3.06	160	4.13	144	7.22	126
28							1.06	334	1.38	290	2.20	231	2.91	204	3.57	187	4.86	170		

6 DIAMETRAL PITCH STEEL 14 1/2° PRESSURE ANGLE 1-1/2" FACE REFERENCE PAGE 25.

No. Teeth	25 RPM		50 RPM		100 RPM		200 RPM		300 RPM		600 RPM		900 RPM		1200 RPM		1800 RPM		3600 RPM	
	H.P.	Torque	H.P.	Torque	H.P.	Torque	H.P.	Torque	H.P.	Torque	H.P.	Torque	H.P.	Torque	H.P.	Torque	H.P.	Torque	H.P.	Torque
11	.38	946	.74	928	1.42	893	2.64	832	3.70	778	6.20	652	8.01	561	9.37	492	11.29	395	14.19	249
12	.41	1030	.80	1008	1.54	968	2.84	896	3.97	834	6.57	691	8.41	589	9.78	514	11.69	409	14.51	254
14	.53	1340	1.04	1308	1.98	1247	3.62	1142	5.01	1053	8.12	853	10.24	717	11.77	618	13.85	485		
15	.59	1491	1.15	1452	2.19	1381	3.99	1257	5.49	1154	8.81	925	11.03	773	12.62	663	14.75	517		
16	.65	1648	1.27	1603	2.41	1519	4.37	1376	5.98	1257	9.51	999	11.83	828	13.47	708	15.65	548		
18	.78	1962	1.51	1902	2.84	1792	5.10	1606	6.92	1455	10.80	1135	13.28	930	15.00	788	17.23	603		
20	.90	2273	1.74	2196	3.26	2057	5.79	1825	7.81	1640	11.97	1258	14.57	1020	16.33	858				
21	.97	2436	1.86	2349	3.48	2194	6.15	1937	8.25	1734	12.56	1319	15.20	1065	16.99	892				
24	1.13	2860	2.18	2745	4.03	2541	7.02	2212	9.32	1958	13.87	1457	16.57	1160	18.35	964				
27	1.32	3335	2.53	3186	4.64	2924	7.97	2512	10.48	2201	15.29	1606	18.05	1264						
30	1.49	3761	2.84	3576	5.17	3255	8.76	2761	11.41	2396	16.35	1717	19.10	1338						

Ratings are based on strength calculation. Basic static strength rating, or for hand operation of above gears is approximately 3 times the 100 RPM rating.

NOTE: Ratings to right of heavy line are not recommended, as pitch line velocity exceeds 1000 feet per minute. They should be used for interpolation purposes only.

*Torque Ratings (Lb. Ins.).

Spur Gears

Approximate Horsepower and Torque* Ratings

For Class I Service (Service Factor = 1.0)

6 DIAMETRAL PITCH CAST IRON 14½° PRESSURE ANGLE 1-1/2" FACE REFERENCE PAGE 26.

No. Teeth	25 RPM		50 RPM		100 RPM		200 RPM		300 RPM		600 RPM		900 RPM		1200 RPM		1800 RPM		3600 RPM	
	H.P.	Torque	H.P.	Torque	H.P.	Torque	H.P.	Torque	H.P.	Torque	H.P.	Torque	H.P.	Torque	H.P.	Torque	H.P.	Torque	H.P.	Torque
32	.98	2470	1.86	2341	3.36	2120	5.66	1783	7.32	1539	10.38	1090	12.06	844						
33	1.01	2543	1.91	2406	3.45	2173	5.78	1821	7.46	1567	10.51	1104								
36	1.12	2813	2.10	2650	3.77	2375	6.24	1967	7.99	1678	11.09	1165								
40	1.25	3163	2.35	2962	4.17	2628	6.80	2144	8.62	1811	11.76	1235								
42	1.31	3310	2.45	3090	4.33	2728	7.02	2211	8.85	1858	11.97	1257								
48	1.51	3814	2.80	3530	4.88	3073	7.75	2441	9.64	2025	12.75	1339								
54	1.73	4364	3.18	4005	5.46	3440	8.52	2683	10.47	2199	13.59	1427								
60	1.90	4801	3.47	4371	5.88	3706	9.02	2842	10.97	2305	14.00	1471								
64	2.05	5177	3.72	4688	6.26	3944	9.50	2993	11.48	2411	14.50	1523								
66	2.11	5322	3.81	4807	6.39	4027	9.65	3040	11.62	2442	14.62	1536								
72	2.28	5750	4.09	5153	6.77	4267	10.08	3175	12.03	2528	14.94	1569								
84	2.66	6695	4.69	5912	7.60	4790	11.02	3473	12.96	2724										
96	2.98	7510	5.19	6538	8.24	5193	11.68	3680	13.56	2849										
108	3.35	8436	5.75	7246	8.97	5652	12.45	3924	14.31	3006										
120	3.65	9205	6.19	7806	9.50	5987	12.96	4083												
144	4.23	10664	7.01	8831	10.43	6571	13.79	4347												

5 DIAMETRAL PITCH STEEL 14½° PRESSURE ANGLE 1-3/4" FACE REFERENCE PAGE 26.

No. Teeth	25 RPM		50 RPM		100 RPM		200 RPM		300 RPM		600 RPM		900 RPM		1200 RPM		1800 RPM		3600 RPM	
	H.P.	Torque	H.P.	Torque	H.P.	Torque	H.P.	Torque	H.P.	Torque	H.P.	Torque	H.P.	Torque	H.P.	Torque	H.P.	Torque	H.P.	Torque
11	.63	1583	1.23	1546	2.35	1479	4.31	1360	5.99	1258	9.79	1028	12.41	869	14.33	753	16.96	594		
12	.68	1723	1.33	1680	2.54	1600	4.64	1462	6.40	1345	10.33	1085	12.99	910	14.91	783	17.49	613		
14	.89	2241	1.73	2176	3.26	2057	5.89	1855	8.04	1689	12.68	1332	15.70	1099	17.82	936	20.60	721		
15	.99	2491	1.92	2415	3.61	2275	6.47	2039	8.79	1847	13.71	1441	16.86	1181	19.05	1000	21.88	766		
16	1.09	2754	2.11	2664	3.97	2501	7.07	2227	9.56	2008	14.76	1550	18.03	1262	20.27	1065				
18	1.30	3275	2.50	3156	4.67	2942	8.22	2590	11.01	2313	16.68	1752	20.13	1410	22.46	1179				
20	1.50	3793	2.89	3640	5.35	3370	9.31	2934	12.36	2597	18.40	1933	21.98	1539	24.34	1279				

5 DIAMETRAL PITCH CAST IRON 14½° PRESSURE ANGLE 1-3/4" FACE REFERENCE PAGE 26.

No. Teeth	25 RPM		50 RPM		100 RPM		200 RPM		300 RPM		600 RPM		900 RPM		1200 RPM		1800 RPM		3600 RPM	
	H.P.	Torque	H.P.	Torque	H.P.	Torque	H.P.	Torque	H.P.	Torque	H.P.	Torque	H.P.	Torque	H.P.	Torque	H.P.	Torque	H.P.	Torque
24	1.13	2859	2.16	2723	3.95	2487	6.73	2120	8.79	1847	12.69	1333	14.88	1042						
25	1.20	3034	2.29	2885	4.17	2626	7.07	2227	9.20	1933	13.19	1385	15.41	1079						
30	1.49	3752	2.80	3534	5.03	3168	8.32	2623	10.66	2238	14.80	1554	17.00	1191						
35	1.80	4548	3.37	4246	5.95	3749	9.64	3038	12.15	2554	16.44	1727								
40	2.08	5242	3.85	4852	6.70	4224	10.65	3356	13.25	2783	17.53	1841								
45	2.36	5947	4.33	5459	7.44	4689	11.60	3657	14.27	2997	18.52	1945								
50	2.60	6543	4.73	5956	8.01	5051	12.29	3874	14.95	3142	19.08	2005								
55	2.90	7321	5.25	6612	8.79	5539	13.27	4182	15.99	3359	20.11	2112								
60	3.14	7910	5.62	7089	9.31	5870	13.86	4368	16.56	3478	20.55	2159								
70	3.65	9213	6.45	8135	10.46	6592	15.16	4779	17.84	3748										
80	4.17	10514	7.26	9153	11.54	7270	16.35	5152	18.99	3989										
100	5.03	12671	8.52	10745	13.08	8241	17.84	5620												

4 DIAMETRAL PITCH STEEL 14½° PRESSURE ANGLE 2" FACE REFERENCE PAGE 27.

No. Teeth	25 RPM		50 RPM		100 RPM		200 RPM		300 RPM		600 RPM		900 RPM		1200 RPM		1800 RPM		3600 RPM	
	H.P.	Torque	H.P.	Torque	H.P.	Torque	H.P.	Torque	H.P.	Torque	H.P.	Torque	H.P.	Torque	H.P.	Torque	H.P.	Torque	H.P.	Torque
11	1.11	2810	2.17	2730	4.10	2584	7.41	2334	10.13	2128	16.01	1682	19.86	1391	22.57	1185	26.14	915		
12	1.21	3057	2.35	2963	4.43	2792	7.94	2502	10.79	2266	16.83	1768	20.69	1449	23.37	1228	26.85	940		
14	1.58	3971	3.04	3831	5.67	3577	10.02	3158	13.46	2827	20.48	2151	24.79	1736	27.70	1455				
15	1.75	4414	3.37	4247	6.26	3948	10.98	3461	14.67	3081	22.06	2318	26.52	1857	29.50	1550				
16	1.93	4876	3.71	4680	6.87	4332	11.97	3772	15.90	3339	23.66	2485	28.26	1979	31.30	1644				
18	2.30	5794	4.39	5535	8.06	5080	13.85	4364	18.20	3824	26.56	2790	31.35	2196						
20	2.66	6703	5.06	6373	9.21	5802	15.61	4920	20.33	4271	29.13	3060	34.04	2384						
22	3.01	7579	5.69	7173	10.28	6478	17.22	5427	22.23	4670	31.33	3291	36.29	2541						

Ratings are based on strength calculation. Basic static strength rating, or for hand operation of above gears is approximately 3 times the 100 RPM rating.

NOTE: Ratings to right of heavy line are not recommended, as pitch line velocity exceeds 1000 feet per minute.

They should be used for interpolation purposes only.

*Torque Ratings (Lb. Ins.).

Approximate Horsepower and Torque* Ratings

For Class I Service (Service Factor = 1.0)

4 DIAMETRAL PITCH CAST IRON 14½° PRESSURE ANGLE 2" FACE REFERENCE PAGE 27.

No. Teeth	25 RPM		50 RPM		100 RPM		200 RPM		300 RPM		600 RPM		900 RPM		1200 RPM		1800 RPM		3600 RPM	
	H.P.	Torque	H.P.	Torque	H.P.	Torque	H.P.	Torque	H.P.	Torque	H.P.	Torque	H.P.	Torque	H.P.	Torque	H.P.	Torque	H.P.	Torque
24	2.00	5042	3.77	4750	6.75	4257	11.19	3525	14.32	3008	19.88	2089	22.84	1600						
28	2.43	6129	4.54	5723	8.02	5053	12.99	4094	16.38	3441	22.16	2328								
30	2.62	6599	4.87	6135	8.53	5378	13.69	4314	17.14	3601	22.92	2408								
32	2.86	7211	5.30	6675	9.22	5811	14.65	4616	18.22	3829	24.11	2534								
36	3.25	8187	5.96	7514	10.24	6454	15.98	5034	19.64	4126	25.49	2677								
40	3.64	9177	6.63	8354	11.24	7085	17.24	5433	20.97	4406	26.77	2812								
42	3.80	9588	6.90	8694	11.63	7328	17.69	5575	21.42	4499	27.12	2849								
44	4.04	10181	7.29	9195	12.22	7703	18.46	5816	22.24	4672	27.97	2938								
48	4.36	10999	7.82	9858	12.95	8163	19.28	6074	23.02	4837	28.58	3002								
54	4.97	12530	8.81	11104	14.35	9045	20.94	6598	24.72	5193										
56	5.13	12933	9.06	11419	14.68	9253	21.29	6708	25.04	5261										
60	5.44	13727	9.55	12034	15.32	9652	21.94	6915	25.65	5388										
64	5.86	14763	10.20	12852	16.20	10209	22.95	7233	26.66	5601										
72	6.47	16305	11.11	14005	17.33	10923	24.07	7585	27.65	5810										
80	7.18	18101	12.18	15350	18.68	11772	25.48	8029												
84	7.47	18838	12.60	15877	19.17	12079	25.93	8170												
88	7.76	19561	13.00	16387	19.63	12372	26.35	8304												
96	8.32	20970	13.78	17365	20.50	12922	27.13	8548												



3 DIAMETRAL PITCH STEEL 14½° PRESSURE ANGLE 3" FACE REFERENCE PAGE 27.

No. Teeth	25 RPM		50 RPM		100 RPM		200 RPM		300 RPM		600 RPM		900 RPM		1200 RPM		1800 RPM		3600 RPM	
	H.P.	Torque	H.P.	Torque	H.P.	Torque	H.P.	Torque	H.P.	Torque	H.P.	Torque	H.P.	Torque	H.P.	Torque	H.P.	Torque	H.P.	Torque
11	2.94	7421	5.67	7146	10.56	6652	18.55	5846	24.82	5213	37.47	3936	45.15	3162	50.30	2642				
12	3.20	8067	6.14	7743	11.37	7167	19.80	6239	26.30	5524	39.14	4111	46.74	3273	51.78	2719				
14	4.15	10462	7.92	9979	14.49	9134	24.79	7812	32.48	6824	47.09	4947	55.40	3880						
15	4.61	11618	8.76	11046	15.96	10056	27.06	8528	35.24	7403	50.49	5304	59.01	4132						
16	5.09	12825	9.64	12156	17.47	11008	29.38	9259	38.03	7989	53.89	5661	62.60	4383						
18	6.03	15214	11.37	14333	20.38	12845	33.75	10637	43.20	9076	60.00	6303	68.93	4827						
20	6.97	17570	13.05	16454	23.16	14599	37.80	11913	47.89	10062	65.33	6863								
21	7.46	18795	13.92	17549	24.59	15495	39.84	12556	50.24	10554	67.96	7139								

3 DIAMETRAL PITCH CAST IRON 14½° PRESSURE ANGLE 3" FACE REFERENCE PAGE 27.

No. Teeth	25 RPM		50 RPM		100 RPM		200 RPM		300 RPM		600 RPM		900 RPM		1200 RPM		1800 RPM		3600 RPM	
	H.P.	Torque	H.P.	Torque	H.P.	Torque	H.P.	Torque	H.P.	Torque	H.P.	Torque	H.P.	Torque	H.P.	Torque	H.P.	Torque	H.P.	Torque
24	5.23	13175	9.67	12195	16.84	10617	26.76	8433	33.30	6995	44.05	4627	22.84	1600						
30	6.81	17164	12.40	15626	21.03	13251	32.25	10162	39.23	8241	50.07	5259								
36	8.41	21199	15.07	18998	24.96	15732	37.15	11707	44.37	9322	55.08	5786								
42	9.81	24721	17.32	21828	28.06	17687	40.69	12822	47.87	10056										
48	11.20	28241	19.50	24586	30.99	19530	43.91	13838	51.00	10715										
54	12.71	32043	21.83	27523	34.06	21466	47.30	14906	54.35	11417										
60	13.87	34965	23.52	29651	36.08	22740	49.22	15509												
72	16.35	41223	27.08	34136	40.30	25402	53.32	16803												
84	18.76	47293	30.40	38322	44.08	27782	56.87	17923												
96	20.75	52300	32.96	41545	46.71	29437	59.02	18597												
108	22.99	57968	35.87	45212	49.81	31395	61.84	19486												

Ratings are based on strength calculation. Basic static strength rating, or for hand operation of above gears is approximately 3 times the 100 RPM rating.

NOTE: Ratings to right of heavy line are not recommended, as pitch line velocity exceeds 1000 feet per minute. They should be used for interpolation purposes only.

*Torque Ratings (Lb. Ins.).

Spur Gears

Approximate Horsepower and Torque* Ratings

For Class I Service (Service Factor = 1.0)

A

20 DIAMETRAL PITCH STEEL 20° PRESSURE ANGLE 1/2" FACE REFERENCE PAGE 42.

No. Teeth	25 RPM		50 RPM		100 RPM		200 RPM		300 RPM		600 RPM		900 RPM		1200 RPM		1800 RPM		3600 RPM	
	H.P.	Torque	H.P.	Torque	H.P.	Torque	H.P.	Torque	H.P.	Torque	H.P.	Torque	H.P.	Torque	H.P.	Torque	H.P.	Torque	H.P.	Torque
12	.01	36.5	.03	36.3	.06	35.8	.11	34.9	.16	34.1	.30	31.8	.42	29.7	.53	28.0	.71	25.0	1.08	18.9
14	.02	48.0	.04	47.7	.07	46.9	.14	45.6	.21	44.3	.39	40.9	.54	37.9	.67	35.4	.89	31.2	1.32	23.0
15	.02	53.8	.04	53.3	.08	52.5	.16	50.9	.23	49.3	.43	45.3	.60	41.9	.74	38.9	.97	34.1	1.42	24.9
16	.02	58.6	.05	58.1	.09	57.1	.18	55.2	.25	53.5	.46	48.8	.64	44.9	.79	41.6	1.04	36.3	1.49	26.2
18	.03	68.6	.05	67.9	.11	66.7	.20	64.2	.29	62.0	.53	56.1	.73	51.2	.90	47.1	1.16	40.6	1.64	28.7
20	.03	79.2	.06	78.4	.12	76.8	.23	73.7	.34	70.8	.60	63.5	.82	57.5	1.00	52.6	1.28	44.9	1.78	31.2
24	.04	99.5	.08	98.3	.15	95.8	.29	91.3	.41	87.1	.73	76.7	.98	68.5	1.18	61.9	1.48	51.9	2.00	34.9
25	.04	105	.08	103	.16	101	.30	95.6	.43	91.1	.76	79.9	1.02	71.1	1.22	64.1	1.53	53.5	2.04	35.8
30	.05	132	.10	130	.20	126	.38	119	.53	112	.92	96.4	1.21	84.5	1.43	75.2	1.76	61.6	2.28	40.0
35	.07	165	.13	162	.25	156	.46	145	.65	136	1.09	115	1.42	99.4	1.67	87.5	2.02	70.6	2.55	44.7
40	.08	194	.15	190	.29	182	.53	168	.75	157	1.24	130	1.58	111	1.84	96.6	2.20	77.0	2.73	47.8
45	.09	224	.17	219	.33	209	.61	192	.84	177	1.38	145	1.74	122	2.01	105	2.37	83.0		
50	.10	248	.19	242	.37	230	.66	210	.92	192	1.47	154	1.84	129	2.10	111	2.46	86.1		
60	.12	306	.24	296	.44	279	.79	250	1.08	227	1.68	177	2.07	145	2.34	123	2.69	94.0		
70	.14	365	.28	352	.52	329	.92	291	1.24	260	1.88	198	2.28	160	2.55	134				

20 DIAMETRAL PITCH CAST IRON 20° PRESSURE ANGLE 1/2" FACE REFERENCE PAGE 42.

No. Teeth	25 RPM		50 RPM		100 RPM		200 RPM		300 RPM		600 RPM		900 RPM		1200 RPM		1800 RPM		3600 RPM	
	H.P.	Torque	H.P.	Torque	H.P.	Torque	H.P.	Torque	H.P.	Torque	H.P.	Torque	H.P.	Torque	H.P.	Torque	H.P.	Torque	H.P.	Torque
80	.10	256	.20	246	.36	228	.63	198	.84	176	1.24	131	1.49	104	1.65	86.5				
84	.11	269	.20	257	.38	237	.65	206	.86	181	1.27	134	1.51	106	1.67	87.8				
90	.11	287	.22	274	.40	252	.69	216	.90	189	1.32	138	1.55	109	1.71	89.7				
100	.13	317	.24	302	.44	275	.74	233	.96	202	1.38	145	1.61	113	1.76	92.4				
120	.15	387	.29	365	.52	327	.86	271	1.10	231	1.53	161	1.76	123						
140	.18	447	.33	418	.59	369	.95	299	1.20	251	1.62	170	1.83	128						
160	.21	520	.38	481	.66	419	1.06	333	1.31	276	1.74	183								
180	.23	579	.42	532	.72	457	1.13	356	1.39	292	1.80	189								
200	.25	637	.46	580	.78	492	1.20	377	1.46	306	1.86	195								

16 DIAMETRAL PITCH STEEL 20° PRESSURE ANGLE 3/4" FACE REFERENCE PAGE 43.

No. Teeth	25 RPM		50 RPM		100 RPM		200 RPM		300 RPM		600 RPM		900 RPM		1200 RPM		1800 RPM		3600 RPM	
	H.P.	Torque	H.P.	Torque	H.P.	Torque	H.P.	Torque	H.P.	Torque	H.P.	Torque	H.P.	Torque	H.P.	Torque	H.P.	Torque	H.P.	Torque
12	.03	85.5	.07	84.7	.13	83.4	.26	80.9	.37	78.4	.69	72.0	.95	66.5	1.18	61.8	1.55	54.2	2.26	39.5
14	.04	112	.09	111	.17	109	.33	105	.48	102	.88	92.2	1.20	84.4	1.48	77.7	1.92	67.2	2.73	47.7
15	.05	126	.10	124	.19	122	.37	117	.54	113	.97	102	1.33	92.8	1.62	85.2	2.09	73.1	2.93	51.3
16	.05	136	.11	135	.21	133	.40	127	.58	122	1.04	110	1.42	99.4	1.73	90.8	2.21	77.5	3.07	53.8
18	.06	160	.13	158	.25	155	.47	148	.67	142	1.19	125	1.61	113	1.94	102	2.46	86.2	3.35	58.6
20	.07	185	.14	183	.28	178	.54	169	.77	161	1.35	141	1.80	126	2.16	113	2.70	94.7	3.62	63.3
24	.09	233	.18	229	.35	222	.66	209	.94	198	1.62	170	2.12	149	2.52	132	3.10	108	4.02	70.4
28	.11	283	.22	278	.43	268	.79	250	1.12	235	1.88	198	2.44	171	2.87	151	3.47	122	4.40	77.0
30	.12	308	.24	302	.46	291	.86	270	1.20	253	2.01	211	2.59	181	3.02	159	3.63	127	4.55	79.7
32	.13	340	.26	333	.51	320	.94	296	1.31	275	2.17	228	2.78	195	3.23	170	3.86	135	4.79	83.9
36	.16	395	.31	385	.58	368	1.07	338	1.49	312	2.42	254	3.06	215	3.53	186	4.17	146	5.09	89.1
40	.18	452	.35	440	.66	418	1.21	381	1.66	349	2.67	280	3.34	234	3.82	201	4.47	156	5.37	94.1
48	.22	556	.43	539	.81	508	1.44	455	1.96	412	3.06	322	3.76	264	4.25	223	4.88	171		
56	.26	665	.51	642	.95	599	1.68	529	2.25	474	3.43	360	4.15	291	4.64	244				
60	.28	711	.54	684	1.01	636	1.77	557	2.36	496	3.55	373	4.27	299	4.75	250				
64	.31	779	.59	748	1.10	692	1.91	602	2.54	533	3.78	397	4.51	316	5.00	263				
72	.35	872	.66	833	1.21	764	2.08	656	2.74	575	4.00	420	4.72	330						
80	.39	991	.75	943	1.36	858	2.31	728	3.01	632	4.31	453	5.04	353						

Ratings are based on strength calculation. Basic static strength rating, or for hand operation of above gears is approximately 3 times the 100 RPM rating.

NOTE: Ratings to right of heavy line are not recommended, as pitch line velocity exceeds 1000 feet per minute. They should be used for interpolation purposes only.

*Torque Ratings (Lb. Ins.).

Approximate Horsepower and Torque* Ratings

For Class I Service (Service Factor = 1.0)

16 DIAMETRAL PITCH CAST IRON 20° PRESSURE ANGLE 3/4" FACE REFERENCE PAGE 43.

No. Teeth	25 RPM		50 RPM		100 RPM		200 RPM		300 RPM		600 RPM		900 RPM		1200 RPM		1800 RPM		3600 RPM		
	H.P.	Torque	H.P.	Torque	H.P.	Torque	H.P.	Torque	H.P.	Torque	H.P.	Torque	H.P.	Torque	H.P.	Torque	H.P.	Torque	H.P.	Torque	
96	.28	707	.53	666	.95	597	1.57	494	2.01	421	2.79	293	3.20	224							
128	.38	949	.70	879	1.21	765	1.93	608	2.40	504	3.17	333	3.56	249							
144	.42	1057	.77	970	1.32	833	2.06	650	2.54	533	3.29	346									
160	.47	1195	.86	1088	1.46	923	2.25	707	2.73	574	3.49	366									
192	.56	1406	1.00	1260	1.66	1044	2.46	777	2.94	618	3.65	384									

A

12 DIAMETRAL PITCH STEEL 20° PRESSURE ANGLE 1" FACE REFERENCE PAGE 43.

No. Teeth	25 RPM		50 RPM		100 RPM		200 RPM		300 RPM		600 RPM		900 RPM		1200 RPM		1800 RPM		3600 RPM	
	H.P.	Torque	H.P.	Torque	H.P.	Torque	H.P.	Torque	H.P.	Torque	H.P.	Torque	H.P.	Torque	H.P.	Torque	H.P.	Torque	H.P.	Torque
12	.08	202	.16	200	.31	196	.60	188	.86	181	1.54	162	2.09	147	2.55	134	3.27	114	4.53	79.4
13	.09	233	.18	230	.36	225	.68	215	.98	206	1.75	183	2.36	165	2.86	150	3.63	127	4.97	87.1
14	.11	265	.21	262	.41	256	.77	244	1.11	233	1.96	206	2.63	184	3.18	167	4.00	140	5.42	94.8
15	.12	297	.23	293	.45	285	.86	271	1.23	259	2.16	227	2.88	202	3.46	182	4.34	152	5.80	102
16	.13	323	.25	319	.49	310	.93	294	1.33	279	2.31	243	3.07	215	3.68	193	4.58	160	6.05	106
18	.15	379	.30	373	.57	361	1.08	340	1.53	322	2.63	276	3.46	242	4.10	215	5.04	177	6.55	115
20	.17	437	.34	429	.66	415	1.23	389	1.74	365	2.95	310	3.84	269	4.52	238	5.50	193	7.02	123
21	.19	468	.36	459	.70	443	1.31	413	1.84	388	3.11	327	4.03	282	4.73	249	5.73	201	7.26	127
24	.22	548	.43	537	.82	515	1.51	477	2.11	444	3.50	368	4.48	314	5.21	274	6.22	218	7.72	135
28	.26	667	.52	651	.99	621	1.80	568	2.49	524	4.04	425	5.10	357	5.86	308	6.89	241		
30	.29	720	.56	707	1.07	673	1.94	612	2.68	562	4.29	451	5.37	376	6.15	323	7.19	252		
36	.37	928	.71	899	1.34	847	2.41	759	3.27	688	5.11	537	6.28	440	7.09	373	8.15	285		
42	.44	1112	.85	1073	1.59	1001	2.81	884	3.77	792	5.73	602	6.94	486	7.76	407				
48	.52	1304	.99	1252	1.84	1159	3.20	1009	4.25	893	6.33	665	7.56	529	8.37	440				
54	.60	1505	1.14	1437	2.09	1319	3.60	1133	4.73	993	6.90	724	8.14	570						

12 DIAMETRAL PITCH CAST IRON 20° PRESSURE ANGLE 1" FACE REFERENCE PAGE 44.

No. Teeth	25 RPM		50 RPM		100 RPM		200 RPM		300 RPM		600 RPM		900 RPM		1200 RPM		1800 RPM		3600 RPM	
	H.P.	Torque	H.P.	Torque	H.P.	Torque	H.P.	Torque	H.P.	Torque	H.P.	Torque	H.P.	Torque	H.P.	Torque	H.P.	Torque	H.P.	Torque
60	.40	998	.75	949	1.37	864	2.32	733	3.03	636	4.34	456	5.07	355						
66	.45	1125	.84	1064	1.53	961	2.56	805	3.30	693	4.65	488	5.38	377						
72	.48	1221	.91	1150	1.64	1031	2.71	853	3.47	728	4.81	506	5.53	387						
84	.58	1450	1.07	1354	1.90	1196	3.07	969	3.88	814	5.24	551								
96	.65	1641	1.21	1519	2.10	1322	3.33	1050	4.15	871	5.49	576								
108	.75	1879	1.37	1725	2.35	1482	3.67	1156	4.51	947	5.85	615								
120	.82	2068	1.49	1882	2.53	1596	3.88	1224	4.73	993	6.03	634								
132	.89	2252	1.61	2034	2.70	1704	4.08	1287	4.92	1033	6.19	650								
144	.97	2433	1.73	2181	2.87	1806	4.26	1344	5.09	1070	6.32	664								
168	1.13	2861	2.00	2526	3.25	2047	4.71	1484	5.54	1164										
192	1.27	3209	2.22	2794	3.52	2219	4.99	1573	5.80	1218										
216	1.41	3545	2.42	3045	3.77	2375	5.23	1649	6.01	1263										

Ratings are based on strength calculation. Basic static strength rating, or for hand operation of above gears is approximately 3 times the 100 RPM rating.

NOTE: Ratings to right of heavy line are not recommended, as pitch line velocity exceeds 1000 feet per minute. They should be used for interpolation purposes only.

*Torque Ratings (Lb. Ins.).

Spur Gears

Approximate Horsepower and Torque* Ratings

For Class I Service (Service Factor = 1.0)

10 DIAMETRAL PITCH STEEL 20° PRESSURE ANGLE 1-1/4" FACE REFERENCE PAGE 44.

No. Teeth	25 RPM		50 RPM		100 RPM		200 RPM		300 RPM		600 RPM		900 RPM		1200 RPM		1800 RPM		3600 RPM	
	H.P.	Torque	H.P.	Torque	H.P.	Torque	H.P.	Torque	H.P.	Torque	H.P.	Torque	H.P.	Torque	H.P.	Torque	H.P.	Torque	H.P.	Torque
12	.14	363	.28	358	.55	349	1.06	333	1.51	318	2.66	280	3.57	250	4.30	226	5.40	189	7.27	127
14	.19	477	.37	469	.72	456	1.37	431	1.95	409	3.37	354	4.46	312	5.31	279	6.58	230	8.63	151
15	.21	533	.42	525	.81	509	1.52	479	2.16	453	3.70	389	4.87	341	5.78	303	7.10	249	9.22	161
16	.23	580	.45	571	.88	552	1.64	518	2.32	488	3.96	416	5.18	363	6.12	321	7.47	262	9.60	168
18	.27	679	.53	667	1.02	642	1.90	599	2.67	561	4.48	471	5.79	406	6.79	356	8.19	287	10.33	181
20	.31	784	.61	768	1.17	737	2.16	682	3.02	635	5.00	526	6.41	449	7.45	391	8.90	311	11.04	193
24	.39	983	.76	958	1.45	913	2.65	834	3.65	767	5.89	619	7.41	519	8.50	447	9.98	349		
25	.41	1032	.80	1005	1.52	956	2.76	870	3.80	799	6.10	641	7.64	535	8.74	459	10.21	358		
28	.47	1195	.92	1161	1.74	1097	3.14	990	4.29	901	6.76	710	8.37	586	9.50	499	10.99	385		
30	.52	1300	1.00	1260	1.88	1187	3.38	1064	4.59	964	7.16	752	8.80	616	9.94	522	11.42	400		
35	.64	1615	1.24	1558	2.31	1454	4.08	1284	5.47	1150	8.33	875	10.08	706	11.27	592				
40	.75	1896	1.44	1820	2.67	1685	4.65	1467	6.18	1299	9.20	966	10.99	770	12.17	639				
45	.87	2190	1.66	2092	3.05	1920	5.23	1649	6.88	1445	10.04	1054	11.85	830						
48	.92	2328	1.76	2218	3.21	2026	5.48	1727	7.16	1504	10.33	1085	12.12	849						
50	.96	2420	1.83	2301	3.32	2095	5.64	1777	7.34	1542	10.52	1105	12.29	861						

10 DIAMETRAL PITCH CAST IRON 20° PRESSURE ANGLE 1-1/4" FACE REFERENCE PAGE 44.

No. Teeth	25 RPM		50 RPM		100 RPM		200 RPM		300 RPM		600 RPM		900 RPM		1200 RPM		1800 RPM		3600 RPM	
	H.P.	Torque	H.P.	Torque	H.P.	Torque	H.P.	Torque	H.P.	Torque	H.P.	Torque	H.P.	Torque	H.P.	Torque	H.P.	Torque	H.P.	Torque
55	.65	1638	1.23	1550	2.22	1400	3.72	1173	4.80	1009	6.77	711	7.84	549						
60	.71	1778	1.33	1675	2.38	1501	3.94	1243	5.05	1061	7.01	737	8.06	564						
70	.84	2114	1.57	1974	2.77	1743	4.48	1413	5.65	1187	7.65	803								
80	.98	2462	1.81	2279	3.15	1984	5.00	1576	6.22	1307	8.23	865								
90	1.09	2742	2.00	2517	3.43	2162	5.35	1686	6.58	1382	8.54	897								
100	1.20	3016	2.18	2746	3.70	2329	5.67	1786	6.89	1448	8.80	924								
120	1.45	3650	2.59	3271	4.30	2709	6.40	2016	7.64	1605	9.48	996								
140	1.66	4177	2.93	3688	4.74	2989	6.88	2167	8.09	1699										
160	1.91	4814	3.32	4191	5.28	3329	7.49	2359	8.69	1826										
200	2.30	5802	3.90	4920	5.99	3773	8.17	2573												

8 DIAMETRAL PITCH STEEL 20° PRESSURE ANGLE 1-1/2" FACE REFERENCE PAGE 45.

No. Teeth	25 RPM		50 RPM		100 RPM		200 RPM		300 RPM		600 RPM		900 RPM		1200 RPM		1800 RPM		3600 RPM	
	H.P.	Torque	H.P.	Torque	H.P.	Torque	H.P.	Torque	H.P.	Torque	H.P.	Torque	H.P.	Torque	H.P.	Torque	H.P.	Torque	H.P.	Torque
12	.27	678	.53	667	1.03	647	1.93	609	2.74	576	4.71	495	6.19	434	7.35	386	9.03	316	11.72	205
14	.35	890	.69	874	1.34	843	2.50	787	3.51	738	5.92	622	7.68	537	9.01	473	10.91	382	13.81	242
15	.39	996	.77	976	1.49	939	2.77	873	3.88	816	6.49	681	8.35	585	9.76	513	11.73	411	14.70	257
16	.43	1084	.84	1061	1.62	1018	2.99	943	4.18	877	6.92	727	8.85	620	10.30	541	12.30	431		
18	.50	1268	.98	1238	1.88	1183	3.44	1086	4.77	1003	7.78	817	9.84	689	11.35	596	13.40	469		
20	.58	1462	1.13	1424	2.15	1354	3.91	1233	5.39	1131	8.64	908	10.82	758	12.38	650	14.47	507		
22	.66	1651	1.27	1604	2.41	1518	4.35	1371	5.95	1250	9.41	989	11.67	817	13.27	698	15.36	538		
24	.73	1831	1.41	1775	2.65	1672	4.75	1498	6.46	1357	10.08	1059	12.39	868	14.00	735	16.08	563		
28	.88	2224	1.70	2145	3.18	2003	5.61	1768	7.54	1583	11.47	1204	13.88	972	15.51	815				
32	1.06	2664	2.03	2557	3.76	2367	6.54	2060	8.68	1824	12.92	1358	15.44	1081	17.10	898				
36	1.22	3082	2.34	2944	4.29	2703	7.37	2321	9.68	2034	14.13	1484	16.68	1168						

Ratings are based on strength calculation. Basic static strength rating, or for hand operation of above gears is approximately 3 times the 100 RPM rating.

NOTE: Ratings to right of heavy line are not recommended, as pitch line velocity exceeds 1000 feet per minute. They should be used for interpolation purposes only.

*Torque Ratings (Lb. Ins.).

Approximate Horsepower and Torque* Ratings

For Class I Service (Service Factor = 1.0)

8 DIAMETRAL PITCH CAST IRON

20° PRESSURE ANGLE 1-1/2" FACE

REFERENCE PAGE 45.

No. Teeth	25 RPM		50 RPM		100 RPM		200 RPM		300 RPM		600 RPM		900 RPM		1200 RPM		1800 RPM		3600 RPM	
	H.P.	Torque	H.P.	Torque	H.P.	Torque	H.P.	Torque	H.P.	Torque	H.P.	Torque	H.P.	Torque	H.P.	Torque	H.P.	Torque	H.P.	Torque
40	.84	2111	1.59	2007	2.90	1928	4.92	1550	6.40	1345	9.18	964	10.72	751						
44	.95	2384	1.79	2256	3.23	2038	5.42	1707	6.99	1469	9.86	1035	11.41	799						
48	1.03	2587	1.93	2437	3.47	2184	5.74	1809	7.35	1543	10.20	1072	11.72	821						
56	1.22	3080	2.28	2876	4.03	2539	6.53	2057	8.23	1729	11.14	1170								
60	1.30	3283	2.42	3052	4.25	2676	6.81	2146	8.53	1792	11.40	1198								
64	1.42	3588	2.64	3322	4.59	2892	7.29	2297	9.07	1905	12.00	1260								
72	1.59	3997	2.91	3669	5.00	3151	7.80	2458	9.59	2014	12.44	1307								
80	1.79	4525	3.27	4119	5.54	3493	8.50	2679	10.34	2173	13.20	1386								
88	1.96	4929	3.53	4451	5.92	3729	8.93	2816	10.76	2262	13.54	1422								
96	2.11	5325	3.79	4772	6.27	3952	9.33	2941	11.15	2341	13.83	1453								
112	2.49	6266	4.39	5533	7.11	4483	10.31	3250	12.13	2549										
120	2.64	6651	4.63	5830	7.42	4677	10.63	3351	12.43	2610										
128	2.79	7028	4.85	6118	7.71	4860	10.93	3444	12.69	2667										

A

6 DIAMETRAL PITCH STEEL

20° PRESSURE ANGLE

2" FACE

REFERENCE PAGE 45 & 46.

No. Teeth	25 RPM		50 RPM		100 RPM		200 RPM		300 RPM		600 RPM		900 RPM		1200 RPM		1800 RPM		3600 RPM	
	H.P.	Torque	H.P.	Torque	H.P.	Torque	H.P.	Torque	H.P.	Torque	H.P.	Torque	H.P.	Torque	H.P.	Torque	H.P.	Torque	H.P.	Torque
12	.63	1559	1.24	1565	2.38	1502	4.41	1391	6.16	1294	10.20	1072	13.06	915	15.19	798	18.14	635		
14	.83	2097	1.62	2046	3.10	1951	5.67	1786	7.84	1647	12.70	1334	16.02	1122	18.42	967	21.67	759		
15	.93	2345	1.81	2284	3.45	2171	6.27	1977	8.64	1814	13.85	1455	17.35	1215	19.85	1043	23.20	812		
16	1.01	2551	1.97	2480	3.73	2351	6.76	2129	9.26	1945	14.71	1545	18.30	1282	20.85	1095	24.21	848		
18	1.18	2981	2.29	2889	4.32	2722	7.74	2440	10.52	2210	16.41	1724	20.18	1413	22.79	1197	26.18	917		
21	1.46	3671	2.81	3541	5.25	3306	9.26	2919	12.44	2613	18.93	1988	22.91	1605	25.61	1345				
24	1.70	4294	3.27	4122	6.05	3815	10.54	3322	14.00	2941	20.83	2188	24.88	1743	27.56	1448				
27	1.98	4986	3.78	4763	6.94	4372	11.92	3755	15.66	3241	22.85	2400	26.98	1889						
30	2.25	5660	4.27	5381	7.77	4899	13.18	4155	17.17	3607	24.60	2584	28.75	2013						

6 DIAMETRAL PITCH CAST IRON

20° PRESSURE ANGLE

2" FACE

REFERENCE PAGE 46.

No. Teeth	25 RPM		50 RPM		100 RPM		200 RPM		300 RPM		600 RPM		900 RPM		1200 RPM		1800 RPM		3600 RPM	
	H.P.	Torque	H.P.	Torque	H.P.	Torque	H.P.	Torque	H.P.	Torque	H.P.	Torque	H.P.	Torque	H.P.	Torque	H.P.	Torque	H.P.	Torque
33	1.53	3847	2.89	3641	5.22	3288	8.74	2755	11.28	2370	15.90	1670	18.42	1290						
36	1.71	4316	3.23	4066	5.78	3644	9.58	3018	12.26	2575	17.02	1788	19.56	1370						
42	2.04	5148	3.81	4807	6.73	4244	10.91	3439	13.76	2891	18.62	1955								
48	2.38	6009	4.41	5563	7.68	4843	12.21	3847	15.19	3191	20.09	2111								
54	2.74	6899	5.02	6333	8.63	5440	13.46	4243	16.55	3477	21.48	2256								
60	3.01	7591	5.48	6910	9.30	5860	14.26	4494	17.35	3645	22.14	2326								
66	3.38	8515	6.10	7691	10.22	6443	15.44	4864	18.60	3907	23.39	2457								
72	3.65	9200	6.54	8245	10.83	6827	16.12	5080	19.26	4045	23.90	2511								
84	4.30	10835	7.59	9566	12.30	7752	17.83	5620	20.98	4407										
96	4.82	12152	8.39	10579	13.33	8404	18.90	5955	21.95	4611										
108	5.47	13800	9.40	11583	14.67	9245	20.37	6420	23.41	4917										
120	5.97	15059	10.13	12770	15.54	9793	21.20	6680												

Ratings are based on strength calculation. Basic static strength rating, or for hand operation of above gears is approximately 3 times the 100 RPM rating.

NOTE: Ratings to right of heavy line are not recommended, as pitch line velocity exceeds 1000 feet per minute. They should be used for interpolation purposes only.

*Torque Ratings (Lb. Ins.).

Spur Gears

Approximate Horsepower and Torque* Ratings

For Class I Service (Service Factor = 1.0)

5 DIAMETRAL PITCH STEEL 20° PRESSURE ANGLE 2-1/2" FACE REFERENCE PAGE 46.

No. Teeth	25 RPM		50 RPM		100 RPM		200 RPM		300 RPM		600 RPM		900 RPM		1200 RPM		1800 RPM		3600 RPM	
	H.P.	Torque	H.P.	Torque	H.P.	Torque	H.P.	Torque	H.P.	Torque	H.P.	Torque	H.P.	Torque	H.P.	Torque	H.P.	Torque	H.P.	Torque
12	1.14	2865	2.22	2794	4.22	2662	7.71	2431	10.65	2237	17.19	1805	21.61	1513	24.80	1302	29.09	1019		
14	1.49	3756	2.89	3647	5.47	3449	9.87	3110	13.48	2832	21.25	2233	26.31	1843	29.87	1569	34.53	1209		
15	1.67	4198	3.23	4069	6.08	3833	10.90	3435	14.81	3112	23.11	2427	28.41	1990	32.09	1686	36.87	1291		
16	1.81	4565	3.50	4416	6.58	4146	11.72	3693	15.85	3329	24.47	2570	29.89	2093	33.61	1765				
18	2.12	5332	4.08	5138	7.60	4789	13.38	4216	17.92	3766	27.15	2852	32.77	2295	36.56	1920				
20	2.44	6141	4.68	5894	8.66	5456	15.07	4750	20.02	4205	29.79	3129	35.58	2492	39.41	2070				

5 DIAMETRAL PITCH CAST IRON 20° PRESSURE ANGLE 2-1/2" FACE REFERENCE PAGE 46.

No. Teeth	25 RPM		50 RPM		100 RPM		200 RPM		300 RPM		600 RPM		900 RPM		1200 RPM		1800 RPM		3600 RPM	
	H.P.	Torque	H.P.	Torque	H.P.	Torque	H.P.	Torque	H.P.	Torque	H.P.	Torque	H.P.	Torque	H.P.	Torque	H.P.	Torque	H.P.	Torque
24	1.82	4599	3.48	4381	6.35	4002	10.82	3411	14.15	2972	20.41	2144	23.95	1677						
25	1.91	4826	3.64	4588	6.63	4177	11.24	3542	14.64	3075	20.97	2203	24.51	1716						
28	2.21	5571	4.18	5267	7.54	4750	12.60	3970	16.23	3410	22.81	2396	26.37	1847						
30	2.40	6050	4.52	5700	8.10	5108	13.42	4230	17.18	3609	23.86	2506	27.41	1920						
35	2.97	7477	5.54	6982	9.78	6164	15.85	4995	19.98	4199	27.04	2840								
40	3.47	8737	6.42	8087	11.17	7040	17.75	5593	22.08	4639	29.21	3068								
45	3.98	10040	7.31	9216	12.56	7916	19.59	6174	24.09	5060	31.26	3284								
50	4.38	11046	7.98	10056	13.53	8528	20.75	6540	25.25	5304	32.22	3384								
60	5.32	13399	9.53	12008	15.78	9944	23.48	7400	28.05	5892	34.81	3657								
70	6.27	15794	11.06	13945	17.93	11300	26.00	8192	30.58	6425										
80	7.23	18229	12.59	15869	20.00	12605	28.34	8932	32.92	6916										
100	8.71	21969	14.78	18630	22.67	14288	30.92	9745												
110	9.68	24409	16.22	20449	24.50	15439	32.88	10362												
120	10.38	26168	17.19	21669	25.58	16125	33.85	10666												
140	11.70	29508	18.97	23910	27.50	17334	35.49	11182												
160	13.30	33526	21.13	26631	29.94	18870	37.83	11921												
180	14.49	36534	22.61	28495	31.40	19787	38.97	12281												

Ratings are based on strength calculation. Basic static strength rating, or for hand operation of above gears is approximately 3 times the 100 RPM rating.

NOTE: Ratings to right of heavy line are not recommended, as pitch line velocity exceeds 1000 feet per minute. They should be used for interpolation purposes only.

*Torque Ratings (Lb. Ins.).

Gear Gauge Set



14-1/2° and 20° Pressure Angles

This handy, steel gear gauge set consists of 16 leaves — 24 gauges — to measure both 14-1/2° and 20° Pressure Angle tooth form, in diametral pitch sizes 64, 48, 32, 24, 20, 16, 12, 10, 8, 6, 5 and 4. Pitch sizes 8, 6, 5 and 4 both 14-1/2° and 20° are cut on individual leaves. Pitch sizes 64 through 10 inclusive, have both 14-1/2° and 20° Pressure Angles on a single leaf.

SOLD ONLY AS A COMPLETE SET

ORDER BY CATALOG NUMBER OR ITEM CODE

Catalog Number	Item Code
Gear Gauge	06000

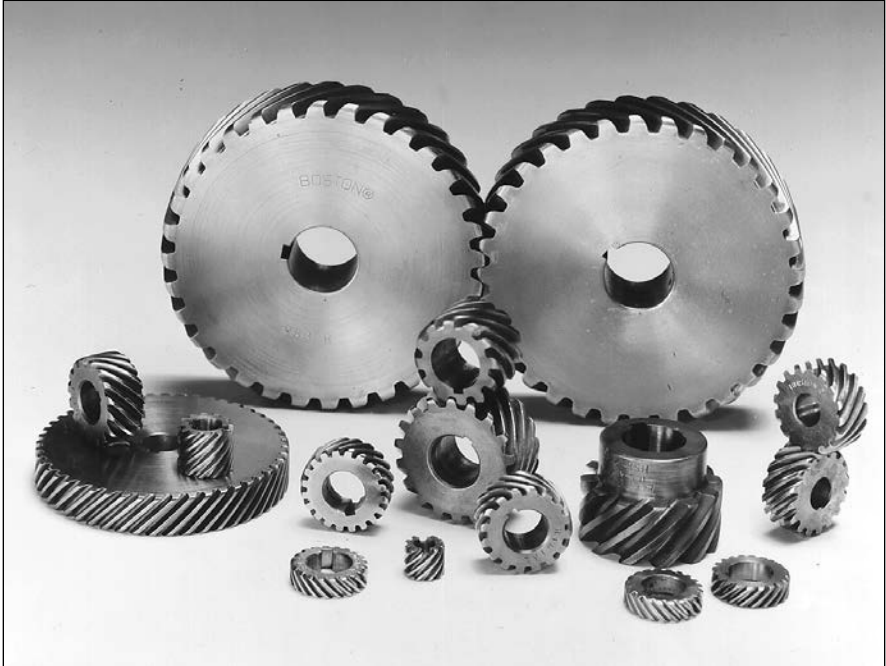

CATALOG NUMBER / DIMENSIONS 64-65
SELECTION PROCEDURE..... 66
HORSEPOWER & TORQUE RATINGS..... 67-68
STOCK ALTERED / CUSTOM HELICAL GEARS 3-5
HELICAL GEAR ENGINEERING INFORMATION..... 308-314

Helical Gears

24 through 10 Transverse Diametral Pitch (Steel – Hardened)

14-1/2° Normal Pressure Angle – 45° Helix Angle

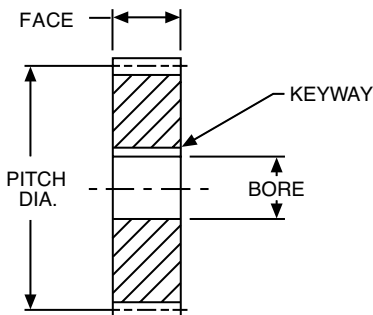

STANDARD TOLERANCES

DIMENSION		TOLERANCE
BORE	All	±.0005

REFERENCE PAGES

- Alterations — 322
- Horsepower Ratings — 67
- Lubrication — 322
- Materials — 323
- Selection Procedure — 66

NOTE: Normal Diametral Pitch is equal to the Transverse Diametral Pitch divided by the cosine of the Helix Angle.

These gears are hardened all over, except as noted. Teeth on all steel gears are polished.

ALL DIMENSIONS IN INCHES
ORDER BY CATALOG NUMBER OR ITEM CODE

No. of Teeth	Pitch Dia.	Bore	Keyway	Style See Page 323	RIGHT HAND		LEFT HAND			
					Catalog Number	Item Code	Catalog Number	Item Code		
24					Face: 8-15 Teeth = .375"					
TRANSVERSE DIAMETRAL PITCH					18-72 Teeth = .250"					
8	.333	.1875	*	A	H2408R	18268	H2408L	18270		
10	.417	.250	**		H2410R	18272	H2410L	18274		
12	.500				H2412R	18276	H2412L	18278		
15	.625	.375	1/8 x 1/16		H2415R	18280	H2415L	18282		
18	.750				H2418R	18284	H2418L	18286		
20	.833	.500			H2420R	18288	H2420L	18290		
24	1.000				H2424R	18292	H2424L	18294		
30	1.250				H2430R	18296	H2430L	18298		
36	1.500	.625			H2436R†	18300	H2436L†	18302		
48	2.000				H2448R†	18304	H2448L†	18306		
60	2.500				H2460R†	18308	H2460L†	18310		
72	3.000				H2472R†	18312	H2472L†	18314		
20					Face: 8-15 Teeth = .563"					
TRANSVERSE DIAMETRAL PITCH					18-72 Teeth = .375"					
8	.400	.250		**	A	H2008R	18228	H2008L	18230	
10	.500	.3125		H2010R		18232	H2010L	18234		
12	.600	.375	1/8 x 1/16	H2012R		18236	H2012L	18238		
15	.750	.4375		H2015R		18240	H2015L	18242		
20	1.000	.500		H2020R		18244	H2020L	18246		
25	1.250	.625		H2025R		18248	H2025L	18250		
30	1.500			H2030R†		18252	H2030L†	18254		
40	2.000	.750		H2040R†		18256	H2040L†	18258		
50	2.500			H2050R†		18260	H2050L†	18262		
60	3.000			H2060R†		18264	H2060L†	18266		
16						Face = .500"				
TRANSVERSE DIAMETRAL PITCH										
12	.750	.375		1/16 x 1/32	A	H1612R	18200	H1612L	18202	
16	1.000			1/8 x 1/16		H1616R	18204	H1616L	18206	
20	1.250	.500	H1620R			18208	H1620L	18210		
24	1.500		H1624R†			18212	H1624L†	18214		
32	2.000		H1632R†			18216	H1632L†	18218		
40	2.500		H1640R†			18220	H1640L†	18222		
48	3.000		H1648R†			18224	H1648L†	18226		
12						Face = .750"				
TRANSVERSE DIAMETRAL PITCH										
12	1.000		1/8 x 1/16	A	H1212R	18170	H1212L	18168		
15	1.250	.625			H1215R	18174	H1215L	18172		
18	1.500				H1218R†	18178	H1218L†	18176		
24	2.000				H1224R†	18182	H1224L†	18180		
30	2.500				H1230R†	18186	H1230L†	18184		
36	3.000				H1236R†	18190	H1236L†	18188		
10					Face = .875"					
TRANSVERSE DIAMETRAL PITCH										
8	.800	.375	1/16 x 1/32	A	H1008R	18130	H1008L	18128		
10	1.000	.500	1/8 x 1/16		H1010R	18134	H1010L	18132		
12	1.200	.625			H1012R	18138	H1012L	18136		
15	1.500				H1015R†	18142	H1015L†	18140		
20	2.000	.750			H1020R†	18146	H1020L†	18144		
25	2.500				H1025R†	18148	H1025L†	18150		
30	3.000				H1030R†	18154	H1030L†	18152		
40	4.000				H1040R†	18158	H1040L†	18156		

*1/16" wide x .04" deep slot cut on end of gear for drive pin, not key.
 **3/32" wide x .06" deep slot cut on end of gear for drive pin, not key.
 †Teeth only hardened.

B

8 and 6 Transverse Diametral Pitch (Bronze & Steel – Hardened)

14-1/2° Normal Pressure Angle – 45° Helix Angle

All gears with hubs have setscrew at 90° to keyway. Steel gears have teeth only hardened, except as noted. Teeth on all steel gears are polished.

ALL DIMENSIONS IN INCHES
ORDER BY CATALOG NUMBER OR ITEM CODE

No. of Teeth	Pitch Dia.	Bore	Hub		Keyway	Style See Page 323	RIGHT HAND		LEFT HAND	
			Dia.	Proj.			Catalog Number	Item Code	Catalog Number	Item Code
8 TRANSVERSE DIAMETRAL PITCH										
							Face without Hubs = 1.000" -with Hubs = .750" Overall Length = Face + Hub Proj.			
STEEL-HARDENED										
8	1.000	.500	-	-	1/8 x 1/16	A	H808R*	18066	H808L*	18064
10	1.250	.625	-	-	1/8 x 1/16	A	H810R*	18070	H810L*	18068
12	1.500	.750	-	-	1/8 x 1/16	A	H812R	18074	H812L	18072
16	2.000	.875	-	-	3/16 x 3/32	A	H816R	18078	H816L	18076
20	2.500						H820R	18082	H820L	18080
24	3.000						H824R	18086	H824L	18084
32	4.000						H832R	18090	H832L	18088
8	1.000	.500	.75	.50	1/8 x 1/16	A	HS808R*	18092	HS808L*	18094
10	1.250	.625	1.00	.50	1/8 x 1/16	A	HS810R*	18096	HS810L*	18098
12	1.500	.750	1.25	.50	3/16 x 3/32	A	HS812R*	18100	HS812L*	18102
16	2.000	1.000	2.00	.50	1/4 x 1/8	A	HS816R	18104	HS816L	18106
20	2.500						HS820R	18108	HS820L	18110
24	3.000						HS824R	18112	HS824L	18114
32	4.000						HS832R	18116	HS832L	18118
40	5.000						HS840R	18120	HS840L	18122
48	6.000		2.25				HS848R	18124	HS848L	18126
BRONZE										
8	1.000	.500	.75	.50	1/8 x 1/16	A	HB808R	18356	HB808L	18358
10	1.250	.625	1.00	.50	1/8 x 1/16	A	HB810R	18360	HB810L	18362
12	1.500	.750	1.24	.50	3/16 x 3/32	A	HB812R	18364	HB812L	18366
16	2.000	1.000	2.00	.50	1/4 x 1/8	A	HB816R	18368	HB816L	18370
20	2.500						HB820R	18372	HB820L	18374
24	3.000						HB824R	18376	HB824L	18378
32	4.000						HB832R	18380	HB832L	18382
40	5.000					B	HB840R	18384	HB840L	18386
48	6.000		2.25			B	HB848R	18388	HB848L	18390
6 TRANSVERSE DIAMETRAL PITCH										
							Face without Hubs = 1.250" -with Hubs = 1.000" Overall Length = Face + Hub Proj.			
STEEL-HARDENED										
8	1.333	.625	-	-	1/8 x 1/16	A	H608R	18000	H608L	18002
10	1.667	.750	-	-	3/16 x 3/32	A	H610R	18004	H610L	18006
12	2.000	1.000	-	-	1/4 x 1/8	A	H612R	18010	H612L	18008
15	2.500						H615R	18014	H615L	18012
18	3.000						H618R	18018	H618L	18016
24	4.000						H624R	18022	H624L	18020
8	1.333	.625	1.00	.75	1/8 x 1/16	A	HS608R	18024	HS608L	18026
9	1.500	.750	1.18	.75	3/16 x 3/32	A	HS609R	18028	HS609L	18030
10	1.667	.750	1.34	.75	3/16 x 3/32	A	HS610R	18032	HS610L	18034
12	2.000	1.000	1.62	.75	1/4 x 1/8	A	HS612R	18036	HS612L	18038
15	2.500	1.250	2.00	.75	5/16 x 5/32	A	HS615R	18040	HS615L	18042
18	3.000						HS618R	18044	HS618L	18046
20	3.333						HS620R	18048	HS620L	18050
24	4.000						HS624R	18052	HS624L	18054
30	5.000		2.50				HS630R	18056	HS630L	18058
36	6.000						HS636R	18060	HS636L	18062
BRONZE										
12	2.000	1.000	1.62	.75	1/4 x 1/8	A	HB612R	18328	HB612L	18330
15	2.500	1.250	2.00	.75	5/16 x 5/32	A	HB615R	18332	HB615L	18334
18	3.000						HB618R	18336	HB618L	18338
20	3.333						HB620R	18340	HB620L	18342
24	4.000						HB624R	18344	HB624L	18346
30	5.000		2.50			B	HB630R	18348	HB630L	18350
36	6.000					B	HB636R	18352	HB636L	18354

*Hardened all over.

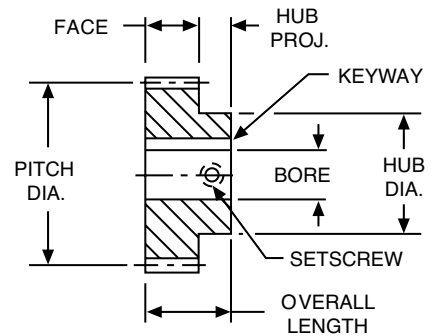

STANDARD TOLERANCES

DIMENSION	TOLERANCE
BORE	All ±.0005

REFERENCE PAGES

Alterations — 322
Horsepower Ratings — 67, 68
Lubrication — 322
Materials — 323
Selection Procedure — 66

NOTE: Normal Diametral Pitch is equal to the Transverse Diametral Pitch divided by the cosine of the Helix Angle.

Helical Gears

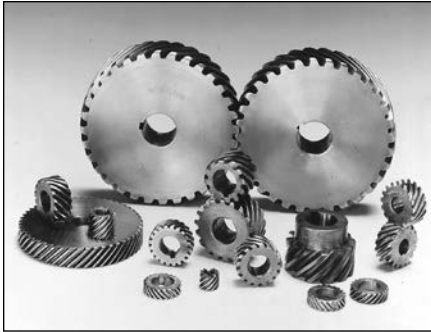

Boston standard stock helical gears are made with a 45° helix angle to transmit motion and/or power between non-intersecting shafts that are parallel or at 90° to each other. They are stocked both right and left-handed. For parallel shaft operation, helical gears having opposite hand helix angles are required, while for shafts at 90° the same hand helix must be used.

For parallel shaft applications, helical gears provide overlapping tooth contact. This results in a smoother, quieter operation and higher horsepower capacity than afforded by spur gears of comparable size.

For 90° shaft applications, the tooth contact area is very small which considerably limits the load capacity. Horsepower ratings are not tabulated in this catalog, for 90° applications.

Boston helical gears are top hobbed, resulting in extremely close concentricity between the pitch diameter and the outside diameter.

B

Selection Procedure

Approximate horsepower and torque ratings for selected sizes (numbers of teeth) at various operating speeds (RPM) are given for hardened steel helical gears. The ratings are based on the beam strength of the gear tooth. These ratings are for parallel shaft applications under normal operating conditions, that is: properly mounted and lubricated, carrying a smooth load for not more than 10 hours per day or a moderate shock load not more than 15 minutes in two hours (Service Factor 1.0). Refer to Table 1, below, for other types of service.

Ratings for gear sizes or speeds not listed may be interpolated from the values indicated. Pitchline velocities are limited as reflected by the lack of ratings for larger numbers of teeth at higher RPM's in the selection chart. Application in this area is not recommended.

Ref. Parallel shafts are approximately 98% efficient
90° shafts are approximately 50% efficient

Horsepower ratings for bronze gears are approximately 33% of these ratings.

1. Determine service factor.
 - a. Using Application Classification Chart I, pages 331-332 determine service factor or
 - b. With knowledge of operating conditions and load classification, select service factor from Table 1.

2. Determine Design Horsepower.

Design HP = Application Load × Service Factor (Table 1)

3. Select pinion with horsepower capacity equal to (or greater than) design horsepower determined in Step 2. Reference Rating Pages 67, 68.
4. Select a driven gear with a catalog rating equal to (or greater than) the horsepower determined in Step 2.

TABLE 1

Service Factor	Operating Conditions
.8	Uniform – not more than 15 minutes in 2 hours.
1.0	Moderate Shock – not more than 15 minutes in 2 hours. Uniform – not more than 10 hours per day.
1.25	Moderate Shock – not more than 10 hours per day. Uniform – more than 10 hours per day.
1.50	Heavy Shock – not more than 15 minutes in 2 hours. Moderate Shock – more than 10 hours per day.
1.75	Heavy Shock – not more than 10 hours per day.
2.0	Heavy Shock – more than 10 hours per day.

Heavy shock loads and/or severe wear conditions may require the use of higher service factors. Consultation with factory is recommended in these applications.

Helical Gears

Approximate Horsepower and Torque* Ratings

For Class I Service (Service Factor = 1.0)

No.	25 RPM		50 RPM		100 RPM		200 RPM		300 RPM		600 RPM		900 RPM		1200 RPM		1800 RPM		3600 RPM																						
	Teeth	H.P.	Torque	H.P.	Torque	H.P.	Torque	H.P.	Torque	H.P.	Torque	H.P.	Torque	H.P.	Torque	H.P.	Torque	H.P.	Torque	H.P.	Torque																				
8 DIAMETRAL PITCH – 11.31 NORMAL DIAMETRAL PITCH HARDENED STEEL																					1.000" FACE																				
8	.13	323	.25	319	.50	313	.95	300	1.4	288	2.5	258	3.3	234	4.1	214	5.2	183	7.2	127																					
10	.17	428	.34	422	.65	412	1.20	391	1.8	373	3.1	327	4.2	291	5.0	262	6.3	219	8.4	146																					
12	.21	534	.42	525	.81	509	1.50	480	2.2	453	3.7	389	4.9	341	5.8	304	7.1	249	9.2	162																					
16	.29	740	.57	725	1.1	696	2.00	644	2.9	599	4.7	496	6.1	423	7.0	370	8.4	294	10.4	182																					
20	.38	947	.73	923	1.4	877	2.50	799	3.5	733	5.6	588	7.0	491	8.0	421	9.3	328	11.1	197																					
24	.46	1150	.88	1114	1.7	1050	3.00	941	4.1	852	6.3	665	7.7	545	8.8	462	10.1	352	11.9	208																					
32	.61	1547	1.20	1485	2.2	1374	3.80	1196	5.0	1059	7.5	788	9.0	628	9.9	521	11.1	389	12.7	221																					
8 DIAMETRAL PITCH – 11.31 NORMAL DIAMETRAL PITCH BRONZE																					.750" FACE																				
8	.04	97	.08	95.8	.15	93.8	.29	90.0	.41	86.5	.74	77.5	1.00	70.2	1.22	64.2	1.56	54.8	2.17	38.0																					
10	.05	128	.10	127	.20	123	.37	117	.53	112	.93	98.1	1.25	87.3	1.50	78.7	1.88	65.7	2.51	43.9																					
12	.06	160	.12	158	.24	153	.46	144	.65	136	1.11	117	1.46	102	1.73	91.1	2.13	74.7	2.77	48.4																					
16	.09	222	.17	217	.33	209	.61	193	.86	180	1.42	149	1.81	127	2.11	111	2.52	88.2	3.13	54.7																					
20	.11	284	.22	277	.42	263	.76	240	1.05	220	1.68	176	2.10	147	2.41	126	2.81	98.4	3.38	59.2																					
24	.14	345	.27	334	.50	315	.90	282	1.22	256	1.90	199	2.33	163	2.64	138	3.03	106	3.56	62.3																					
32	.18	464	.35	445	.65	412	1.14	359	1.51	318	2.75	236	2.69	188	2.98	156	3.34	117																							
40	.23	582	.44	553	.80	504	1.36	427	1.76	371	2.53	266	2.95	207	3.23	169	3.55	124																							
48	.28	695	.52	655	.93	587	1.54	486	1.97	414	2.74	288	3.15	220	3.40	179																									
6 DIAMETRAL PITCH – 8.48 NORMAL DIAMETRAL PITCH HARDENED STEEL																					1.000" FACE																				
8	.01	572	.45	564	.87	548	1.65	520	2.35	494	4.09	430	5.44	381	6.50	342	8.09	283	10.70	187																					
9	.26	664	.52	653	1.00	633	1.89	597	2.68	564	4.61	484	6.06	424	7.19	378	8.84	310	11.47	201																					
10	.30	758	.59	745	1.14	720	2.14	674	3.02	634	5.11	537	6.66	466	7.84	412	9.54	334	12.17	213																					
12	.37	944	.73	924	1.41	887	2.61	821	3.64	764	6.02	633	7.71	540	8.97	471	10.71	375	13.29	233																					
15	.48	1217	.94	1185	1.79	1127	3.26	1026	4.48	942	7.19	755	9.00	630	10.30	541	12.04	421	14.48	253																					
18	.59	1478	1.14	1433	2.14	1350	3.84	1210	5.22	1096	8.14	855	10.00	700	11.30	593	12.98	454	15.25	267																					
20	.66	1670	1.28	1613	2.40	1511	4.25	1340	5.73	1204	8.79	924	10.69	749	11.99	630	13.65	478																							
24	.80	2024	1.54	1942	2.85	1798	4.97	1565	6.60	1386	9.82	1031	11.72	821	12.98	682	14.55	510																							
30	1.01	2546	1.92	2420	3.50	2203	5.93	1868	7.72	1622	11.06	1162	12.92	905	14.11	741	15.54	544																							
36	1.21	3048	2.28	2872	4.08	2573	6.76	2131	8.65	1818	12.02	1262	13.81	967	14.92	783																									
6 DIAMETRAL PITCH – 8.48 NORMAL DIAMETRAL PITCH HARDENED STEEL																					1.250" FACE																				
8	.28	715	.56	705	1.09	685	2.06	650	2.94	617	5.12	537	6.79	476	8.13	427	10.11	354	13.37	234																					
10	.38	948	.74	931	1.43	899	2.67	842	3.77	792	6.39	672	8.32	583	9.80	515	11.93	418	15.22	266																					
12	.47	1180	.92	1155	1.76	1109	3.26	1026	4.55	955	7.53	791	9.64	675	11.21	589	13.38	469	16.61	291																					
15	.60	1521	1.18	1482	2.24	1409	4.07	1282	5.60	1177	8.99	944	11.25	788	12.87	676	15.04	527	18.10	317																					
18	.73	1848	1.42	1791	2.68	1687	4.80	1512	6.52	1370	10.17	1068	12.50	876	14.12	742	16.22	568	19.06	334																					
24	1.00	2529	1.93	2428	3.57	2247	6.21	1956	8.24	1732	12.27	1289	14.65	1026	16.23	852	18.19	637																							
6 DIAMETRAL PITCH – 8.48 NORMAL DIAMETRAL PITCH BRONZE																					1.000" FACE																				
12	.15	378	.29	370	.56	355	1.04	328	1.46	306	2.41	253	3.08	216	3.59	188	4.28	150	5.32	93.1																					
15	.19	487	.38	474	.72	451	1.30	410	1.79	377	2.88	302	3.60	252	4.12	216	4.81	169	5.79	101																					
18	.23	591	.45	513	.86	540	1.54	484	2.09	439	3.25	342	4.00	280	4.52	237	5.19	182	6.10	107																					
20	.26	668	.51	645	.96	604	1.70	536	2.29	482	3.52	369	4.28	300	4.80	252	5.46	191																							
24	.32	810	.62	777	1.14	719	1.99	626	2.64	554	3.93	412	4.69	328	5.19	273	5.82	204																							
30	.40	1018	.77	968	1.40	881	2.37	747	3.09	649	4.42	465	5.17	362	5.65	296	6.22	218																							
36	.48	1219	.91	1149	1.63	1029	2.70	852	3.46	727	4.81	505	5.52	387	5.97	313																									

Ratings are based on strength calculation. Basic static strength rating, or for hand operation of above gears is approximately 3 times the 100 RPM rating.

NOTE: Ratings to right of heavy line exceed 1500 Feet per Minute and should be used for interpolation purposes only.

*Torque Rating (Lb. Ins.)



CATALOG NUMBER / DIMENSIONS

MITER GEARS.....	70-72
SPIRAL MITER GEARS.....	73
BEVEL GEARS.....	74-77
SPIRAL BEVEL GEARS.....	78

SELECTION PROCEDURE.....	79
--------------------------	----

HORSEPOWER AND TORQUE RATINGS

MITER GEARS.....	80-81
BEVEL GEARS.....	82
SPIRAL MITER GEARS.....	83
SPIRAL BEVEL GEARS.....	83

STOCK ALTERED / CUSTOM MITER AND BEVEL GEARS.....	3-5
---	-----

MITER / BEVEL GEAR ENGINEERING INFORMATION	315-317
--	---------

Miter Gears

48 through 20 Diametral Pitch (Nylon, Brass, Stainless Steel & Steel – Unhardened)

1:1 Ratio 20° Pressure Angle



All gears have “Coniflex”® tooth form, except as noted.

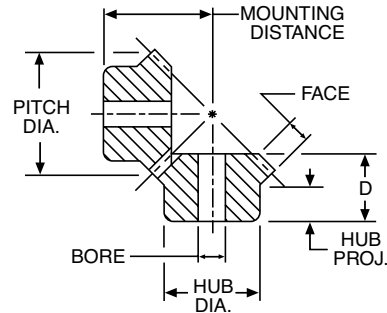

REFERENCE PAGES

Alterations — 322
Lubrication — 322
Materials — 323

STANDARD TOLERANCES*

DIMENSION		TOLERANCE
BORE	All	±.0005

*Brass and Steel only.

ALL DIMENSIONS IN INCHES
ORDER BY CATALOG NUMBER OR ITEM CODE

No. of Teeth	Pitch Dia.	Face	Bore	MD *	D	Hub		Catalog Number	Item Code	Catalog Number	Item Code	Catalog Number	Item Code	Catalog Number	Item Code
						Dia.	Proj.								
48 DIAMETRAL PITCH															
						MOLDED NYLON				BRASS		STAINLESS STEEL		STEEL UNHARDENED	
15	.312	.07	.125	.312	.215	.25	.13	GP4815†‡	54096	G460Y†	12126	GSS460Y†	49984	—	—
18	.375	.08	.125	.406	.286	.33	.19	GP4818Y†	54097	—	—	—	—	—	—
						.31	.16	—	—	G461Y†	12128	GSS461Y†	49985	L94Y†	12140
24	.500	.08	.1875	.531	.375	.38	.25	GP4824Y†	54098	—	—	—	—	—	—
32 DIAMETRAL PITCH															
16	.500	.12	.1875	.500	.349	.41	.19	GP3216Y†	54099	G462Y†	12114	GSS462Y†	49986	L97Y†	12146
24	.750	.14	.1875	.688	.406	.50	.19	GP3224Y†	54100	—	—	—	—	—	—
					.427	.50	.25	—	—	G463Y†	12116	GSS463Y†	49987	L95Y†	12142
30 DIAMETRAL PITCH															
15	.500	.12	.1875	.500	.349	.41	.19	—	—	—	—	—	—	L93Y	12138
24 DIAMETRAL PITCH															
24	1.000	.20	.250	.906	.567	.62	.19	GP2424Y†	54101	—	—	—	—	—	—
						.28		—	—	G464Y	12100	—	—	L96Y	12144
30	1.250	.23	.250	1.031	.590	.62	.31	GP2430Y†	54102	G465Y	12102	—	—	—	—
36	1.500	.23	.3125	1.188	.620	.69	.31	GP2436Y†	54103	G466Y	12104	—	—	—	—
20 DIAMETRAL PITCH															
12	.600	.13	.250	.672	.489	.50	.31	—	—	—	—	—	—	L98Y	12148

*Mounting Distance (MD) must not be made less than dimension shown, see Page 316.

†Not “Coniflex” tooth form. Can be furnished with “Coniflex” tooth on special order.

‡Acetal.

16 through 10 Diametral Pitch (Nylon & Steel – Unhardened & Hardened)

1:1 Ratio 20° Pressure Angle

All gears have “Coniflex”® tooth form, except as noted.
All hardened steel gears have teeth only hardened, except as noted, and are equipped with standard keyways and setscrews.

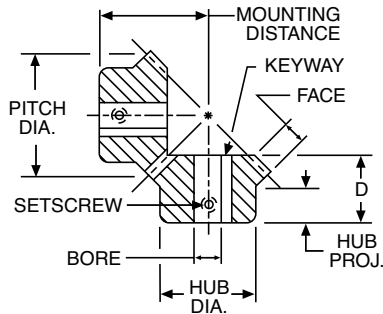

STANDARD TOLERANCES*

DIMENSION		TOLERANCE
BORE	All	±.0005

*Steel only.

REFERENCE PAGES

Alterations — 322
Horsepower Ratings — 80, 81
Lubrication — 322
Materials — 323
Selection Procedure — 79

ALL DIMENSIONS IN INCHES
ORDER BY CATALOG NUMBER OR ITEM CODE

No. of Teeth	Pitch Dia.	Face	Bore	MD *	D	Hub		Catalog Number	Item Code	Catalog Number	Item Code	Catalog Number	Item Code
						Dia.	Proj.						
16 DIAMETRAL PITCH													
						MOLDED NYLON			STEEL UNHARDENED		STEEL HARDENED		
12	.750	.16	.3125	.812	.583	.62	.38	—	—	L99Y	12150	—	—
16	1.000	.23	.375	1.062	.755	.75	.44	GP1616Y†	54104	L110Y	12174	HLK110Y**	12326
20	1.250	.28	.4375	1.250	.849	1.00	.50	—	—	L111Y	12176	—	—
24	1.500	.32	.500	1.375	.880	1.00	.50	—	—	L112Y	12156	—	—
32	2.000	.39	.500	1.562	.875	1.25	.38	GP1632Y‡	54105	—	—	—	—
14 DIAMETRAL PITCH													
14	1.000	.20	.375 .4375	1.062	.739	.88	.50	—	—	L124Y L100Y	12202 12152	—	—
12 DIAMETRAL PITCH													
15	1.250	.29	.375 .4375 .500	1.250	.864	1.00	.50	—	—	L125Y L126Y L101Y	12204 12206 12154	—	—
18	1.500	.33	.500 .625	1.500	1.021	1.25	.63	—	—	L127Y L102Y	12208 12158	HLK102Y	12330
21	1.750	.40	.500 .5625 .625 .750	1.750	1.192	1.38	.69	—	—	L119Y L120Y L121Y L133Y	12190 12192 12194 12218	HLK121Y	12334
24	2.000	.44	.500	1.875	1.224	1.31	.69	—	—	L113Y	12178	—	—
30	2.500	.55	.625	2.312	1.489	1.62	.84	—	—	L114Y	12180	HLK114Y	12332
10 DIAMETRAL PITCH													
20	2.000	.45	.500 .625 .750	2.000	1.364	1.62	.81	—	—	L128Y L129Y L103Y	12210 12212 12160	HLK129Y HLK103Y	12348 12344
25	2.500	.56	.750 .875 1.000	2.438	1.630	2.00	.94	—	—	L130Y L104Y L131Y	12214 12162 12216	HLK130Y HLK104Y HLK131Y	12350 12346 12352

*Mounting Distance (MD) must not be made less than dimension shown, see Page 316.

†Not “Coniflex” tooth form.

**Hardened all over.

‡Nylon (Mineral Filled).

Miter Gears

8 through 4 Diametral Pitch (Steel – Unhardened, Hardened & Cast Iron)

1:1 Ratio 20° Pressure Angle



All gears have “Coniflex”® tooth form, except as noted. All hardened steel gears have teeth only hardened, except as noted, and are equipped with standard keyways and setscrews. All unhardened steel gears have no keyway and no setscrew.

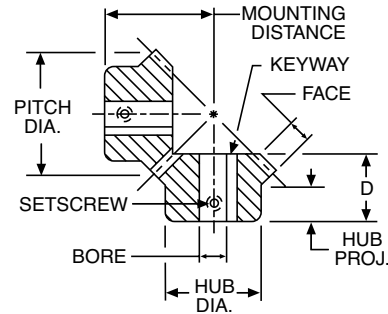

REFERENCE PAGES

- Alterations — 322
- Horsepower Ratings — 80, 81
- Lubrication — 322
- Materials — 323
- Selection Procedure — 79

STANDARD TOLERANCES

DIMENSION		TOLERANCE
BORE	All	±.0005

ALL DIMENSIONS IN INCHES
ORDER BY CATALOG NUMBER OR ITEM CODE

No. of Teeth	Pitch Dia.	Face	Bore	MD *	D	Hub		Catalog Number	Item Code	Catalog Number	Item Code	Catalog Number	Item Code
						Dia.	Proj.						
8 DIAMETRAL PITCH													
						STEEL UNHARDENED				STEEL HARDENED		CAST IRON	
24	3.000	.66	.750	2.562	1.583	1.75	.81	L115Y	12182	HLK115Y	12366	—	—
		.68	1.000 1.250			2.750	1.786	2.50	1.00	L105Y-A L116Y	12164 12184	HLK105YA HLK116Y	12362 12368
28	3.500	.77	1.000 1.1875 1.250	3.250	2.099	2.50	1.25	L117Y	12186	HLK117Y	12370	—	—
		.77	.875					2.875	1.724	2.00	.88	L132Y L106Y	12196 12166
32	4.000	.85	1.000	3.625	2.286	3.00	1.13	L123Y	12200	HLK123Y	12372	OA828Y-1	12418
		.85	.875	3.438	2.098	2.25	1.12	—	—	—	—	OA832Y-1	12420
6 DIAMETRAL PITCH													
24	4.000	.87	1.250 1.500	3.625	2.317	3.00	1.31	L118Y L107Y	12188 12168	HLK118Y HLK107Y	12386 12384	OA624Y†	12412
27	4.500	.96	1.250 1.500	4.125	2.630	3.25	1.50	L134Y L135Y	12220 12222	—	—	—	—
30	5.000	1.16	1.000	4.250	2.640	2.50	1.38	—	—	—	—	OA630Y-1	12414
36	6.000	1.28	1.125	4.625	2.605	2.88	1.19	—	—	—	—	OA636Y-1	12416
5 DIAMETRAL PITCH													
25	5.000	1.12	1.375 1.500 1.750	4.625	3.005	3.50	1.75	L122Y L136Y L108Y	12198 12224 12170	HLK122Y — HLK108Y	12398 — 12396	— — OA525Y	— — 12408
4 DIAMETRAL PITCH													
24	6.000	1.35	1.500 1.750	5.500	3.567	4.00	1.94	L137Y L109Y	12226 12172	— HLK109Y	— 12404	— OA424Y**	— 12406
28	7.000	1.43	2.000	6.000	3.630	5.00	1.94	L138Y	12228	—	—	—	—

*Mounting Distance (MD) must not be made less than dimension shown, see Page 316.

†Hub Dia. — 2.750"

**Hub Proj. — 2.000"

Spiral Miter Gears

18 through 5 Diametral Pitch (Steel – Unhardened & Hardened)

1:1 Ratio 20° Pressure Angle – 35° Spiral Angle

All hardened steel gears have teeth only hardened, except as noted, and are equipped with standard keyways and set-screws.

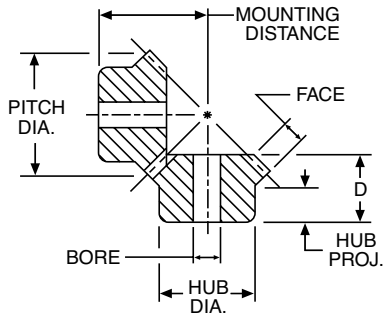

STANDARD TOLERANCES

DIMENSION		TOLERANCE
BORE	All	±.0005

REFERENCE PAGES

Alterations – 322
 Horsepower Ratings – 83
 Lubrication – 322
 Materials – 323
 Selection Procedure – 79

ALL DIMENSIONS IN INCHES
 ORDER BY CATALOG NUMBER OR ITEM CODE

No. of Teeth	Pitch Dia.	Face	Bore	MD *	D	Hub		Catalog Number	Item Code	Catalog Number	Item Code
						Dia.	Proj.				
18 DIAMETRAL PITCH											
						STEEL UNHARDENED			STEEL HARDENED		
18	1.000	.22	.375	1.062	.739	.75	.44	LSA110Y-R LSA110Y-L	12310 12312	HLSK110Y-R† HLSK110Y-L†	12322 12324
12 DIAMETRAL PITCH											
15	1.250	.30	.500	1.250	.864	1.00	.50	LSA101Y-R LSA101Y-L	12282 12284	HLSK101Y-R† HLSK101Y-L†	12336 12338
18	1.500	.34	.625	1.500	1.021	1.25	.56	LSA102Y-R LSA102Y-L	12286 12288	HLSK102Y-R HLSK102Y-L	12340 12342
10 DIAMETRAL PITCH											
20	2.000	.47	.750	2.000	1.364	1.62	.78	LSA103Y-R LSA103Y-L	12290 12292	HLSK103Y-R HLSK103Y-L	12354 12356
25	2.500	.58	.875	2.438	1.630	2.00	.91	LSA104Y-R LSA104Y-L	12294 12296	HLSK104Y-R HLSK104Y-L	12358 12360
8 DIAMETRAL PITCH											
28	3.500	.78	1.1875	3.250	2.099	2.50	1.25	LSA106Y-R LSA106Y-L	12302 12304	HLSK106Y-R HLSK106Y-L	12376 12378
7 DIAMETRAL PITCH											
21	3.000	.69	1.000	2.750	1.786	2.50	.88	LSA105YA-R LSA105YA-L	12298 12300	HLSK105YA-R HLSK105YA-L	12380 12382
6 DIAMETRAL PITCH											
24	4.000	.89	1.250	3.625	2.317	3.00	1.31	LSA118Y-R	12314	HLSK118Y-R	12392
			LSA118Y-L					12316	HLSK118Y-L	12394	
			LSA107Y-R					12306	HLSK107Y-R	12388	
			1.500					LSA107Y-L	12308	HLSK107Y-L	12390
5 DIAMETRAL PITCH											
25	5.000	1.15	1.375	4.625	3.005	3.50	1.75	LSA122Y-R LSA122Y-L	12318 12320	HLSK122Y-R HLSK122Y-L	12400 12402

*Mounting Distance (MD) must not be made less than dimension shown, see Page 316.

†Hardened all over.

Bevel Gears

48 through 20 Diametral Pitch (Brass, Stainless Steel & Steel – Hardened & Unhardened)

20° Pressure Angle

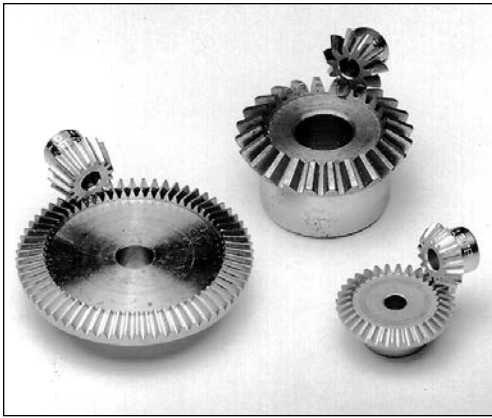

All gears have “Coniflex”[®] tooth form, except as noted. All hardened steel gears have teeth only hardened and are equipped with standard keyways and setscrews, except as noted.

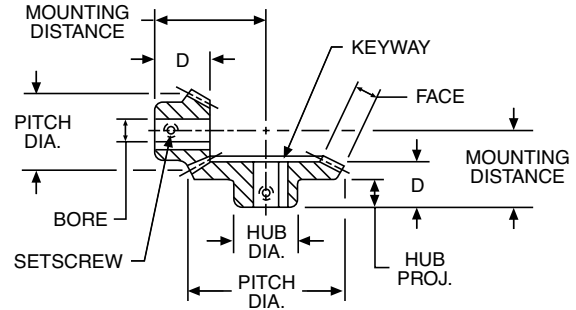

REFERENCE PAGES

Alterations — 322
Lubrication — 322
Materials — 323

STANDARD TOLERANCES

DIMENSION	TOLERANCE
BORE	All ±.0005

ALL DIMENSIONS IN INCHES
ORDER BY CATALOG NUMBER OR ITEM CODE

Ratio	No. of Teeth	Pitch Dia.	Face	Bore	MD *	D	Hub		Catalog Number	Item Code	Catalog Number	Item Code
							Dia.	Proj.				
48 DIAMETRAL PITCH												
									BRASS		STAINLESS STEEL	
2:1	36 18	.750 .375	.12	.1875 .125	.438 .594	.257 .335	.44 .28	.19 .19	G479Y-G† G479Y-P†	12136 12134	GSS479Y-G† GSS479Y-P†	49991 49990
3:1	36 12	.750 .250	.09	.1875 .125	.375 .562	.257 .285	.44 .22	.19 .17	G478Y-G† G478Y-P†	12132 12130	GSS478Y-G† GSS478Y-P†	49989 49988
32 DIAMETRAL PITCH												
2:1	32 16	1.000 .500	.14	.1875	.594 .719	.382 .365	.56 .38	.25 .17	G481Y-G† G481Y-P†	12120 12118	GSS481Y-G† GSS481Y-P†	49993 49992
4:1	64 16	2.000 .500	.24	.3125 .1875	.688 1.250	.445 .500	1.00 .38	.31 .22	G486Y-G† G486Y-P†	12108 12106	GSS486Y-G† GSS486Y-P†	49995 49994
24 DIAMETRAL PITCH												
2:1	36 18	1.500 .750	.24	.250 .1875	.781 1.062	.460 .540	.88 .56	.31 .25	G485Y-G G485Y-P	12124 12122	— —	— —
	48 24	2.000 1.000	.26	.3125 .250	.938 1.375	.507 .630	1.12 .69	.31 .28	G487Y-G G487Y-P	12112 12110	— —	— —
20 DIAMETRAL PITCH												
									STEEL UNHARDENED		STEEL HARDENED	
2:1	20 10	1.000 .500	.18	.375 .1875	.688 .750	.460 .425	.75 .41	.31 .25	L147Y-G L147Y-P	12234 12236	— —	— —
	20 10	1.000 .500	.18	.375 .1875	.688 .750	.460 .425	.75 .41	.31 .25	— —	— —	HL147Y-G† HL147Y-P†	11854 11856

*Mounting Distance (MD) must not be made less than dimension shown, see Page 316.

†Not “Coniflex” tooth form. Can be furnished with “Coniflex” tooth on special order.

‡These gears have No. 47 (.0785) drilled hole in hub. No keyway or setscrew.

16 through 12 Diametral Pitch (Steel – Unhardened, Hardened & Cast Iron)

20° Pressure Angle

All gears have “Coniflex”[®] tooth form.
All Hardened steel gears have teeth only hardened and are equipped with standard keyways and setscrews, except as noted.

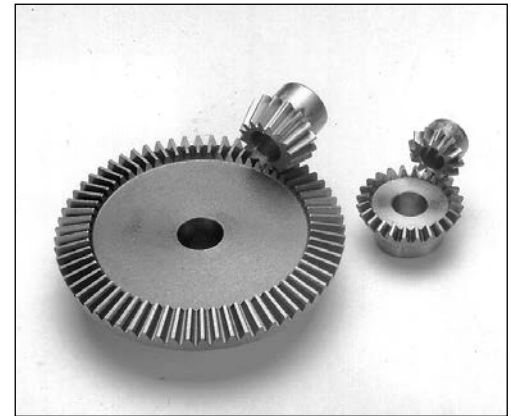
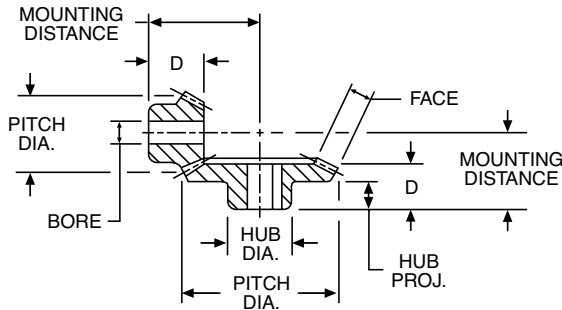

STANDARD TOLERANCES

DIMENSION		TOLERANCE
BORE	All	±.0005

REFERENCE PAGES

Alterations — 322
Horsepower Ratings — 82
Lubrication — 322
Materials — 323
Selection Procedure — 79

ALL DIMENSIONS IN INCHES
ORDER BY CATALOG NUMBER OR ITEM CODE

Ratio	No. of Teeth	Pitch Dia.	Face	Bore	MD *	D	Hub		Catalog Number	Item Code	Catalog Number	Item Code	Catalog Number	Item Code	
							Dia.	Proj.							
16 DIAMETRAL PITCH															
							STEEL UNHARDENED		STEEL HARDENED		CAST IRON GEARS STEEL PINIONS				
1-1/2:1	24	1.500	.26	.500	1.188	.760	1.12	.56	L146Y-G	12230	—	—	—	—	
	16	1.000	.26	.375	1.250	.740	.81	.44	L146Y-P	12232	—	—	—	—	
2:1	24	1.500	.20	.500	1.188	.750	1.12	.56	—	—	HL146Y-G	11850	—	—	
	12	.750	.19	.375	1.125	.575	.66	.34	L148Y-G	12238	HL148Y-G	11858	—	—	
	32	2.000	.36	.500	1.188	.775	1.12	.50	.44	L149Y-G	12242	HL149Y-G	11862	—	—
										L149Y-P	12244	HL149Y-P	11864	—	—
3:1	48	3.000	.42	.625	1.312	.882	1.50	.56	—	—	—	—	PA3316Y-G	12484	
	16	1.000	.42	.4375	2.000	.920	.88	.47	—	—	—	—	PA3316Y-P	12486	
4:1	64	4.000	.49	.625	1.375	.898	2.25	.56	—	—	—	—	PA4416Y-G	12492	
	16	1.000	.49	.500	2.500	.990	.81	.47	—	—	—	—	PA4416Y-P	12494	
6:1	96	6.000	.62	.625	1.688	1.257	1.75	.88	—	—	—	—	PA6616Y-G	12516	
	16	1.000	.62	.500	3.750	1.375	.94	.72	—	—	—	—	PA6616Y-P	12518	
14 DIAMETRAL PITCH															
2:1	28	2.000	.36	.500	1.375	.945	1.62	.66	L150Y-G	12246	HL150Y-G	11866	—	—	
	14	1.000	.35	.375	1.625	.965	.81	.56	—	—	HL150Y-P	11868	—	—	
12 DIAMETRAL PITCH															
1-1/2:1	27	2.250	.42	.500	1.750	1.135	1.50	.78	L151Y-G	12250	—	—	—	—	
	18	1.500	.41	.500	1.875	1.130	1.25	.66	—	—	HL151Y-G	11870	—	—	
2:1	36	3.000	.54	.625	1.875	1.275	2.12	.88	L152BY-G	12260	—	—	—	—	
	18	1.500	.54	.500	2.375	1.385	1.31	.81	L152BY-P	12262	—	—	—	—	
	36	3.000	.54	1.000	1.875	1.275	2.12	.88	L152Y-G	12256	HL152Y-G	11874	—	—	
									—	—	HL152Y-P	11876	—	—	
18	1.500	.53	.625	2.375	1.375	1.31	.81	L152Y-P	12258	—	—	—	—		

*Mounting Distance (MD) must not be made less than dimension shown, see Page 316.

†These gears have No. 47 (.0785) drilled hole in hub. No keyway or setscrew.

Bevel Gears

12 and 10 Diametral Pitch (Steel – Unhardened, Hardened & Cast Iron)

20° Pressure Angle

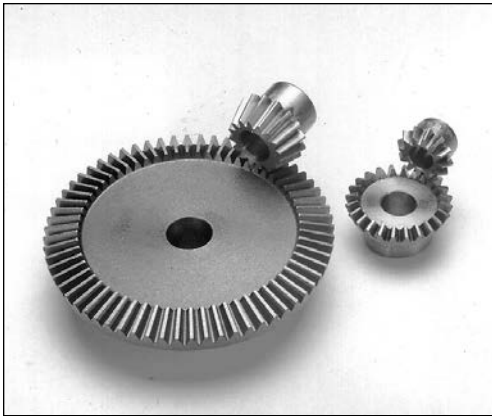

All gears have “Coniflex”® tooth form.

All Hardened steel gears have teeth only hardened and are equipped with standard keyways and setscrews.

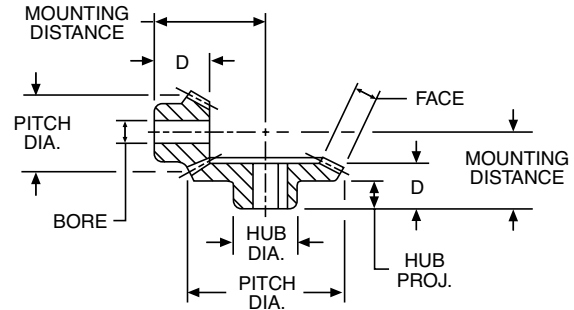

REFERENCE PAGES

- Alterations — 322
- Horsepower Ratings — 82
- Lubrication — 322
- Materials — 323
- Selection Procedure — 79

STANDARD TOLERANCES

DIMENSION		TOLERANCE
BORE	All	±.0005

ALL DIMENSIONS IN INCHES
ORDER BY CATALOG NUMBER OR ITEM CODE

Ratio	No. of Teeth	Pitch Dia.	Face	Bore	MD *	D	Hub		Catalog Number	Item Code	Catalog Number	Item Code	Catalog Number	Item Code	
							Dia.	Proj.							
12 DIAMETRAL PITCH															
										STEEL UNHARDENED		STEEL HARDENED		CAST IRON GEARS STEEL PINIONS	
2:1	36	3.000	.47	.625	1.500	.882	1.44	.50	—	—	—	—	PA3212Y-G	12480	
	18	1.500		.500	2.250	1.205	1.25	.69	—	—	—	—	PA3212Y-P	12482	
	48	4.000	.59	.625	2.000	1.180	1.63	.75	—	—	—	—	PA4212Y-G	12488	
	24	2.000		.500	2.875	1.440	1.50	.75	—	—	—	—	PA4212Y-P	12490	
3:1	54	4.500	.60	.625	1.750	1.063	1.75	.75	—	—	—	—	PA45312Y-G	12532	
	18	1.500		.500	3.000	1.350	1.25	.69	—	—	—	—	PA45312Y-P	12534	
4:1	72	6.000	.61	.750	2.000	1.320	2.00	.95	—	—	—	—	PA6412Y-G	12508	
	18	1.500		.500	3.750	1.365	1.25	.72	—	—	—	—	—	PA6412Y-P	12510
6:1	72	6.000	.74	.750	1.750	1.320	2.00	.95	—	—	—	—	PA6612Y-G	12512	
	12	1.000		.500	3.750	1.495	.94	.72	—	—	—	—	—	PA6612Y-P	12514
10 DIAMETRAL PITCH															
1 1/2:1	30	3.000	.58	.750	2.250	1.445	2.50	1.00	L153Y-G	12264	—	—	—	—	
				1.000						—	—	HL153Y-G	11878	—	—
2:1	20	2.000	.72	.750	2.500	1.525	1.75	.91	L153Y-P	12266	HL153Y-P	11880	—	—	
	40	4.000		.875	2.500	1.695	3.00	1.19	L155Y-G	12268	—	—	—	—	
	20	2.000	.750	3.125	1.805	1.75	1.06	L155Y-P	12270	—	—	—	—		
	40	4.000	.72	1.250	2.500	1.695	3.00	1.19	—	—	HL155Y-G	11882	—	—	
	20	2.000		.875	3.125	1.805	1.75	1.06	—	—	HL155Y-P	11884	—	—	
	50	5.000	.71	.750	2.625	1.600	2.00	1.00	—	—	—	—	PA5210Y-G	12496	
25	2.500	.750		3.375	1.555	2.00	.75	—	—	—	—	—	PA5210Y-P	12498	
3:1	60	6.000	.79	1.000	2.750	1.865	3.00	1.38	L157Y-G	12274	—	—	—	—	
	20	2.000		.875	4.375	2.155	1.75	1.31	L157Y-P	12276	—	—	—	—	
	60	6.000	.79	.875	2.750	1.913	3.00	1.38	—	—	—	—	PA6310Y-G	12500	
20	2.000	.750		4.375	2.155	1.75	1.31	—	—	—	—	—	PA6310Y-P	12502	
4:1	60	6.000	.73	.875	2.250	1.632	2.50	1.13	—	—	—	—	PA6410Y-G	12504	
	15	1.500		.625	3.875	1.610	1.44	.84	—	—	—	—	—	PA6410Y-P	12506
6:1	90	9.000	.86	1.000	2.500	1.820	2.75	1.31	—	—	—	—	PA9610Y-G	12524	
	15	1.500		.625	5.500	1.870	1.44	.97	—	—	—	—	—	PA9610Y-P	12526

*Mounting Distance (MD) must not be made less than dimension shown, see Page 316.

8 through 4 Diametral Pitch (Steel – Unhardened, Hardened & Cast Iron)

20° Pressure Angle

All gears have “Coniflex”® tooth form.
All Hardened steel gears have teeth only hardened and are equipped with standard keyways and setscrews.

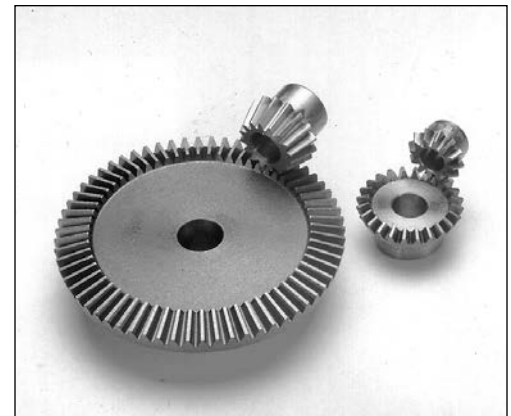
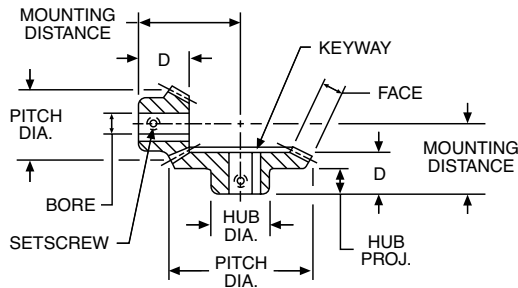

STANDARD TOLERANCES

DIMENSION		TOLERANCE
BORE	All	±.0005

REFERENCE PAGES

- Alterations — 322
- Horsepower Ratings — 82
- Lubrication — 322
- Materials — 323
- Selection Procedure — 79

ALL DIMENSIONS IN INCHES
ORDER BY CATALOG NUMBER OR ITEM CODE

Ratio	No. of Teeth	Pitch Dia.	Face	Bore	MD *	D	Hub		Catalog Number	Item Code	Catalog Number	Item Code	Catalog Number	Item Code	
							Dia.	Proj.							
8 DIAMETRAL PITCH															
									STEEL UNHARDENED		STEEL HARDENED		CAST IRON GEARS STEEL PINIONS		
2:1	40	5.000	.83	1.000 1.500	2.875	1.850	3.00	1.25	L156Y-G —	12252 —	— HL156Y-G	— 11886	— —	— —	
	20	2.500	.83	1.000 .875	4.000 2.875	2.290	2.12	1.41	L156Y-P —	12272 —	HL156Y-P —	11888 —	— —	— —	
3:1	48	6.000	.84	.875 .750	2.375 4.250	1.632 2.085	2.75	1.00 1.19	— —	— —	— —	— —	— —	PA528Y-G PA528Y-P	12424 12426
	16	2.000	.84	.875 .750	2.375 4.250	1.632 2.085	2.75	1.00 1.19	— —	— —	— —	— —	— —	PA638Y-G PA638Y-P	12436 12438
4:1	64	8.000	.85	1.000 .875	2.750 5.250	1.882 2.105	2.75	1.25 1.22	— —	— —	— —	— —	— —	PA848Y-G PA848Y-P	12452 12454
	16	2.000	.85	1.000 .875	2.750 5.250	1.882 2.105	2.75	1.25 1.22	— —	— —	— —	— —	— —	PA948Y-G PA948Y-P	12460 12462
4:1	72	9.000	1.23	1.125 .875	3.250 5.750	2.320 2.470	3.00	1.69 1.22	— —	— —	— —	— —	— —	— —	— —
	18	2.250	1.23	1.125 .875	3.250 5.750	2.320 2.470	3.00	1.69 1.22	— —	— —	— —	— —	— —	— —	— —
6 DIAMETRAL PITCH															
2:1	36	6.000	1.07	1.125	3.500	2.260	3.25	1.50	L158Y-G	12278	—	—	—	—	
	18	3.000	1.06	1.125	4.750	2.765	2.50	1.59	L158Y-P	12280	—	—	—	—	
	36	6.000	1.07	1.750	3.500	2.260	3.25	1.50	—	—	HL158Y-G	11890	—	—	
	18	3.000	1.06	1.125	4.750	2.765	2.50	1.59	—	—	HL158Y-P	11892	—	—	
	36	6.000	1.07	1.125	3.500	2.260	3.25	1.50	—	—	—	—	—	PA626Y-G	12432
	18	3.000	1.07	1.000	4.750	2.765	2.50	1.59	—	—	—	—	—	PA626Y-P	12434
3:1	42	7.000	1.06	1.125	3.750	2.305	3.50	1.50	—	—	—	—	—	PA726Y-G	12440
	21	3.500	1.06	1.000	5.000	2.515	2.50	1.25	—	—	—	—	—	PA726Y-P	12442
3:1	48	8.000	1.18	1.125	3.438	1.898	3.25	1.00	—	—	—	—	—	PA826Y-G	12448
	24	4.000	1.18	1.000	5.438	2.560	2.62	1.25	—	—	—	—	—	PA826Y-P	12450
3:1	45	7.500	1.08	1.125	3.000	2.132	3.25	1.25	—	—	—	—	—	PA7536Y-G	12520
	15	2.500	1.08	.875	5.250	2.575	2.12	1.44	—	—	—	—	—	PA7536Y-P	12522
5 DIAMETRAL PITCH															
2:1	30	6.000	1.05	1.125	3.500	2.257	3.25	1.38	—	—	—	—	—	PA625Y-G	12428
	15	3.000	1.05	1.000	4.375	2.390	2.62	1.28	—	—	—	—	—	PA625Y-P	12430
3:1	45	9.000	1.32	1.250	3.750	2.507	3.75	1.69	—	—	—	—	—	PA935Y-G	12456
	15	3.000	1.32	1.000	5.875	2.685	2.62	1.31	—	—	—	—	—	PA935Y-P	12458
4 DIAMETRAL PITCH															
2:1	32	8.000	1.40	1.125	4.250	2.695	3.75	1.56	—	—	—	—	—	PA824Y-G	12444
	16	4.000	1.40	1.125	6.000	3.350	3.25	1.81	—	—	—	—	—	PA824Y-P	12446

*Mounting Distance (MD) must not be made less than dimension shown, see Page 316.

Spiral Bevel Gears

30 through 8 Diametral Pitch (Steel – Unhardened & Hardened)

20° Pressure Angle – 35° Spiral Angle

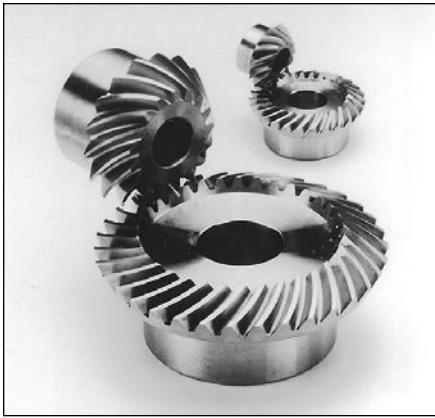

All Hardened steel gears have teeth only hardened and are equipped with standard keyways and setscrews, except as noted. All pinions are left hand.

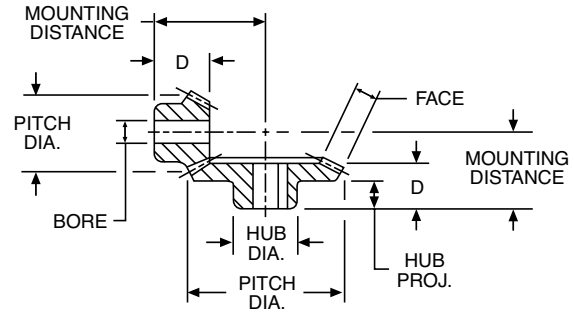

REFERENCE PAGES

- Alterations — 322
- Horsepower Ratings — 83
- Lubrication — 322
- Materials — 323
- Selection Procedure — 79

STANDARD TOLERANCES

DIMENSION		TOLERANCE
BORE	All	±.0005

ALL DIMENSIONS IN INCHES
ORDER BY CATALOG NUMBER OR ITEM CODE

Ratio	No. of Teeth	Pitch Dia.	Face	Bore	MD *	D	Hub		Catalog Number	Item Code	Catalog Number	Item Code
							Dia.	Proj.				
30 DIAMETRAL PITCH												
STEEL UNHARDENED										STEEL HARDENED		
2:1	26	.87	.14	.250	.688	.480	.75	.38	SS302-G	11938	—	—
	13	.43		.1875	.750	.453	.38	.30	SS302-P	11940	—	—
	26	.87	.14	.375	.688	.480	.75	.38	—	—	SH302-G	11914
	13	.43		.1875	.750	.453	.38	.30	—	—	SH302-P†	11916
19 DIAMETRAL PITCH												
2:1	26	1.37	.25	.500	1.000	.730	1.12	.42	SS192-G	11934	—	—
	13	.68		.3125	1.062	.623	.62	.33	SS192-P	11936	—	—
	26	1.37	.25	.625	1.000	.730	1.12	.42	—	—	SH192-G	11910
	13	.68		.3125	1.062	.623	.62	.33	—	—	SH192-P†	11912
14 DIAMETRAL PITCH												
2:1	26	1.86	.31	.625	1.188	.760	1.38	.50	SS142-G	11926	—	—
	13	.93		.4375	1.250	.625	.81	.30	SS142-P	11928	—	—
	26	1.86	.31	.750	1.188	.760	1.38	.50	—	—	SH142-G	11902
	13	.93		.4375	1.250	.625	.81	.30	—	—	SH142-P	11904
	32	2.29	.38	.750	1.375	.855	1.62	.56	SS142-1G	11930	—	—
	16	1.14		.500	1.625	.848	1.00	.45	SS142-1P	11932	—	—
32	2.29	.38	.875	1.375	.855	1.62	.56	—	—	SH142-1G	11906	
16	1.14		.500	1.625	.848	1.00	.45	—	—	SH142-1P	11908	
10 DIAMETRAL PITCH												
2:1	34	3.40	.57	1.000	1.875	1.135	2.00	.75	SS102-G	11922	—	—
	17	1.70		.625	2.375	1.219	1.50	.63	SS102-P	11924	—	—
	34	3.40	.57	1.1875	1.875	1.135	2.00	.75	—	—	SH102-G	11898
	17	1.70		.625	2.375	1.219	1.50	.63	—	—	SH102-P	11900
8 DIAMETRAL PITCH												
2:1	34	4.250	.71	1.250	2.500	1.575	2.88	1.06	SS82-G	11918	—	—
	17	2.125		.750	3.125	1.677	1.88	.94	SS82-P	11920	—	—
	34	4.250	.71	1.500	2.500	1.575	2.88	1.06	—	—	SH82-G	11894
	17	2.125		.750	3.125	1.677	1.88	.94	—	—	SH82-P	11896

*Mounting Distance (MD) must not be made less than dimension shown, see Page 316.

†No keyway or setscrew.

Boston stock miter and bevel gears are designed for transmission of power and/or motion between intersecting shafts at a right angle (90°). Miter gears are a special type of bevel gear designed to operate as pairs being identical in number of teeth and pitch (1 to 1 ratio only). Other Boston stock bevel gear sets are available with ratios from 1-1/2:1 to 6:1.

All Boston standard stock bevels and miters are manufactured with a 20° pressure angle. These bevel gears are made in accordance with AGMA specifications for a long and short addendum system for gears and pinions, which serves to reduce the amount of pinion tooth undercut and to nearly equalize the strength and durability of the gear and pinion. Boston straight tooth bevel and miter gears have generated teeth with “Coniflex”® tooth form, unless otherwise specified.



INTERCHANGE

Stock miter and bevel gears having identical diametral pitch, number of teeth and mounting distance (and spiral angle for spiral bevels) are interchangeable.

SPIRAL VS. STRAIGHT TOOTH

Boston standard stock straight bevel gears can be used for all applications requiring transmission of power and motion between intersecting shafts. Boston standard stock spiral bevel gears have an overlapping tooth action which results in a smoother gear action, lower noise, and higher load capacity than a straight bevel of equal size.

©Trademark of the Gleason Works.

Selection Procedure

Approximate horsepower ratings for selected sizes (number of teeth) at various operating speeds (RPM) are given for Boston standard stock Bevel and Miter gears.

For straight tooth Miter gears, refer to Pages 80, 81.

For straight tooth Bevel gears, refer to Page 82.

For spiral tooth Miter gears, refer to Page 83.

For spiral tooth Bevel gears, refer to Page 83.

All ratings are based on normal operating conditions, that is: properly mounted and lubricated, carrying a smooth load for not more than 10 hours (Service Factor = 1.0). Refer to Table 1 for service factors in other service conditions.

1. Determine service factor.
 - a. Using Application Classification Chart I, pages 331-332 determine service factor or
 - b. With knowledge of operating conditions and load classification, select service factor from Table 1.

2. Determine Design Horsepower.

Design HP = Application Load x Service Factor (Table 1)

3. Select a gear set with horsepower capacity equal to (or greater than) design horsepower determined in Step 2.

TABLE 1

Service Factor	Operating Conditions
.8	Uniform — not more than 15 minutes in 2 hours.
1.0	Moderate Shock — not more than 15 minutes in 2 hours. Uniform — not more than 10 hours per day.
1.25	Moderate Shock — not more than 10 hours per day. Uniform — more than 10 hours per day.
1.50	Heavy Shock — not more than 15 minutes in 2 hours. Moderate Shock — more than 10 hours per day.
1.75	Heavy Shock — not more than 10 hours per day.
2.0	Heavy Shock — more than 10 hours per day.

Heavy shock loads and/or severe wear conditions may require the use of higher service factors. Consultation with factory is recommended in these applications.

Miter Gears

Steel & Iron – Straight Tooth (1:1 Ratio)

L-Series – Unhardened Steel

HLK Series – Hardened Steel (Teeth only)

OA Series – Cast Iron

APPROXIMATE HP & TORQUE* RATINGS FOR CLASS I SERVICE (Service Factor = 1.0)

Catalog Number	Pitch	50 RPM		100 RPM		200 RPM		300 RPM		600 RPM		900 RPM		1200 RPM		1800 RPM	
		HP	Torque	HP	Torque	HP	Torque	HP	Torque	HP	Torque	HP	Torque	HP	Torque	HP	Torque
L110Y L111Y	16	.02	24.7	.03	18.5	.06	18.5	.09	18.5	.15	15.4	.21	14.4	.26	13.4	.33	11.3
L101Y L125Y L126Y	12	.03	37.1	.06	37.1	.12	37.1	.17	35.0	.29	29.9	.40	27.5	.47	24.2	.59	20.2
HLK110Y L112Y	16	.04	49.4	.06	37.1	.12	37.1	.18	37.1	.30	30.9	.42	28.8	.52	26.8	.66	22.6
L102Y L127Y	12	.05	61.8	.09	55.6	.18	55.6	.25	51.5	.42	43.2	.56	38.4	.66	34.0	.81	27.8
L119Y L120Y L121Y L133Y	12	.07	86.5	.14	86.5	.25	77.2	.35	72.1	.60	61.8	.77	52.8	.90	46.3	1.1	37.7
HLK101Y L113Y HLK102Y	12	.06	74.1	.12	74.1	.24	74.1	.34	70.0	.58	59.7	.96	65.9	1.1	56.6	1.3	44.6
L103Y L128Y L129Y	10	.11	136	.20	124	.37	114	.52	107	.87	89.6	1.1	75.5	1.3	66.9	1.5	51.5
L114Y HLK121Y	12	.15	185	.29	179	.52	161	.71	146	1.1	113	1.4	96.1	1.6	82.4	1.9	65.2
L130Y L104Y L131Y	10	.18	222	.33	204	.61	188	.83	171	1.3	134	1.6	110	1.7	87.5	2.2	75.5
HLK103Y HLK129Y	10	.20	247	.40	247	.74	229	1.0	206	1.7	175	2.2	151	2.6	134	3.1	106
OA828Y-1	8	.28	346	.53	327	.93	287	1.2	247	1.9	196	2.3	158	—	—	—	—
L105Y-A L115Y L116Y	8	.30	371	.56	346	1.0	309	1.4	288	2.1	216	2.6	178	3.0	154	3.4	116
HLK114Y	12	.29	358	.58	358	1.0	309	1.4	288	2.3	237	2.8	192	3.2	165	3.9	133
OA832Y-1	8	.37	457	.68	420	1.2	371	1.6	329	2.4	247	2.8	192	—	—	—	—
HLK104Y HLK130Y HLK131Y	10	.33	408	.66	408	1.2	371	1.7	350	2.6	268	3.3	226	3.8	196	4.5	154

Ratings are based on strength calculation. Basic Static Strength Rating, or for hand operation of above gears is approximately 3 times the 100 RPM rating.

NOTE: Ratings to right of heavy line are not recommended, as pitch line velocity exceeds 1000 feet per minute. Use for interpolation purposes only.

*Torque (Lb. Ins.) Output Rating

HP (Input)

C

Steel & Iron – Straight Tooth (1:1 Ratio)

L-Series – Unhardened Steel

HLK Series – Hardened Steel (Teeth only)

OA Series – Cast Iron

APPROXIMATE HP & TORQUE* RATINGS FOR CLASS I SERVICE (Service Factor = 1.0)

Catalog Number	Pitch	50 RPM		100 RPM		200 RPM		300 RPM		600 RPM		900 RPM		1200 RPM		1800 RPM	
		HP	Torque	HP	Torque	HP	Torque	HP	Torque	HP	Torque	HP	Torque	HP	Torque	HP	Torque
L106Y L117Y L132Y	8	.42	519	.79	488	1.4	432	1.9	391	2.8	288	3.4	233	3.8	196	—	—
OA624Y	6	.46	568	.87	537	1.5	463	2.0	412	3.0	309	3.5	240	—	—	—	—
L123Y	8	.55	679	1.0	618	1.8	556	2.4	494	3.5	360	4.2	288	4.6	237	—	—
HLK105YA HLK115Y HLK116Y	8	.55	679	1.1	679	2.0	618	2.7	556	4.3	443	5.3	364	5.9	304	6.9	237
L107Y L118Y	6	.69	852	1.3	803	2.2	679	3.0	618	4.5	463	5.3	364	5.8	299	—	—
OA630Y-1	6	.82	1013	1.5	926	2.5	772	3.2	659	4.7	484	—	—	—	—	—	—
OA525Y	5	.90	1112	1.6	988	2.7	834	3.5	721	5.1	525	—	—	—	—	—	—
L134Y L135Y	6	.90	1112	1.6	988	2.8	865	3.7	762	5.4	556	6.4	439	7.0	360	—	—
HLK106Y HLK117Y HLK132Y	8	.80	988	1.6	988	2.8	865	3.7	762	5.7	587	6.8	467	7.6	391	—	—
OA636Y-1	6	1.1	1359	1.9	1174	3.2	988	4.1	844	5.8	597	—	—	—	—	—	—
HLK123Y	8	1.0	1235	2.0	1235	3.6	1112	4.7	968	7.0	721	8.4	576	9.2	474	—	—
L108Y L122Y L136Y	5	1.3	1606	2.4	1482	4.1	1266	5.3	1091	7.6	782	9.0	618	—	—	—	—
HLK107Y HLK118Y	6	1.3	1606	2.6	1606	4.5	1390	6.0	1235	8.0	824	11.0	755	12.0	618	—	—
OA424Y	4	1.6	1976	2.8	1729	4.6	1421	5.9	1215	8.2	844	—	—	—	—	—	—
OA540Y-1	5	2.0	2471	3.5	2162	5.6	1729	7.0	1441	—	—	—	—	—	—	—	—
L109Y L137Y	4	2.3	2841	4.2	2594	7.0	2162	8.7	1791	12.4	1276	14.3	981	—	—	—	—
L138Y	4	3.0	3706	5.3	3274	8.6	2656	10.8	2224	14.6	1503	16.6	1139	—	—	—	—
HLK108Y HLK122Y	5	2.4	2965	4.9	3026	8.2	2532	10.0	2059	15.0	1544	18.0	1235	—	—	—	—
HLK109Y	4	4.2	5188	8.3	5126	14.0	4324	17.0	3500	25.0	2574	28.0	1922	—	—	—	—

Ratings are based on strength calculation. Basic Static Strength Rating, or for hand operation of above gears is approximately 3 times the 100 RPM rating.

NOTE: Ratings to right of heavy line are not recommended, as pitch line velocity exceeds 1000 feet per minute. Use for interpolation purposes only.

*Torque (Lb. Ins.) Output Rating

HP (Input)

Bevel Gears

Steel & Iron – Straight Tooth

L-Series/PA Series Pinions – Unhardened Steel

PA Series – Cast Iron

HL Series – Hardened Steel (Teeth Only)

APPROXIMATE HP & TORQUE* RATINGS FOR CLASS I SERVICE (Service Factor = 1.0)

Catalog Number	Pitch	Ratio	50 RPM†		100 RPM		200 RPM		300 RPM		600 RPM		900 RPM		1200 RPM		1800 RPM	
			HP	Torque	HP	Torque	HP	Torque	HP	Torque	HP	Torque	HP	Torque	HP	Torque	HP	Torque
L146Y	16	1-1/2:1	.03	55.6	.06	55.6	.11	51.0	.16	49.4	.29	44.8	.40	41.2	.48	37.1	.62	31.9
HL146Y	16		.04	74.1	.08	74.1	.16	74.1	.23	71.0	.41	63.3	.55	56.6	.67	51.7	.86	44.3
L151Y	12		.10	185	.20	185	.37	171	.53	164	.91	141	1.19	122	1.41	109	1.74	89.6
HL151Y	12		.14	259	.27	250	.52	241	.73	225	1.26	195	1.65	170	1.96	151	2.41	124
L153Y	10		.24	445	.45	417	.84	389	1.17	361	1.93	298	2.47	254	2.88	222	3.44	177
HL153Y	10		.33	611	.63	584	1.16	537	1.62	500	2.68	414	3.44	354	4.00	309	4.77	245
L148Y	16	2:1	.02	49.4	.03	37.1	.06	37.1	.09	37.1	.17	35.0	.23	31.6	.28	28.8	.37	25.4
HL148Y	16		.02	49.4	.04	49.4	.09	55.6	.12	49.4	.23	47.4	.32	43.9	.39	40.1	.52	35.7
L149Y	16		.04	98.8	.09	111	.17	105	.24	98.8	.43	88.5	.58	79.6	.71	73.1	.91	62.5
L150Y	14		.05	124	.09	111	.18	111	.26	107	.47	96.8	.64	87.8	.77	79.3	.99	67.9
HL150Y	14		.07	173	.13	161	.25	154	.36	148	.65	134	.88	121	1.07	110	1.38	94.7
HL149Y	16		.06	148	.12	148	.23	142	.33	136	.60	124	.81	111	.99	102	1.27	87.2
PA3212Y	12	2:1	.04	99	.09	111	.16	99	.23	95	.40	82	.52	71	.62	64	.76	52.2
PA4212Y	12		.08	198	.16	198	.29	179	.41	169	.68	140	.87	119	1.00	103	1.20	82.4
L152Y	12		.14	346	.27	334	.50	309	.72	296	1.23	253	1.62	222	1.92	198	2.36	162
PA5210Y	10		.15	371	.28	346	.51	315	.70	288	1.10	226	1.40	192	1.60	165	—	—
HL152Y	12		.19	469	.37	457	.70	432	.99	408	1.71	352	2.24	307	2.66	274	3.27	224
L155Y	10		.30	741	.58	716	1.08	667	1.51	622	2.50	515	3.20	439	3.73	384	4.45	305
PA528Y	8	2:1	.20	494	.38	469	.70	432	.96	395	1.50	309	1.90	261	2.20	226	—	—
L156Y	8		.54	1334	1.03	1272	1.88	1161	2.59	1066	4.16	856	5.21	715	5.96	614	6.97	478
HL155Y	10		.42	1038	.81	1001	1.50	926	2.10	865	3.48	716	4.45	611	5.18	533	6.18	424
PA626Y	6		.40	988	.75	926	1.30	803	1.80	741	2.90	597	3.50	480	4.00	412	—	—
PA625Y	5		.43	1062	.82	1013	1.50	926	2.00	824	3.10	638	3.80	522	4.30	443	—	—
PA726Y	6		.48	1186	.89	1099	1.60	988	2.10	865	3.90	803	—	—	—	—	—	—
L158Y	6	2:1	1.07	2644	2.02	2495	3.62	2236	4.92	2026	7.67	1579	9.43	1294	10.65	1096	12.24	840
PA826Y	6		.63	1556	1.20	1482	2.00	1235	2.70	1112	4.00	824	4.80	659	—	—	—	—
HL156Y	8		.76	1878	1.44	1779	2.62	1618	3.60	1482	5.78	1190	7.24	994	8.28	852	9.68	664
PA824Y	4		.98	2421	1.80	2224	3.20	1976	4.20	1729	7.30	1503	7.50	1029	—	—	—	—
HL158Y	6		1.49	3681	2.80	3459	5.02	3101	6.83	2812	10.65	2193	13.10	1798	14.79	1522	17.00	1167
PA3316Y	16		3:1	.05	185	.11	204	.20	185	.30	185	.53	164	.72	148	.88	136	1.12
PA45312Y	12	.16		593	.31	574	.59	547	.84	519	1.44	445	1.89	389	2.24	346	2.75	283
PA6310Y	10	.34		1260	.66	1223	1.21	1121	1.70	1050	2.81	868	3.60	741	4.18	645	5.00	515
PA638Y	8	.43		1594	.82	1519	1.52	1408	2.12	1309	3.51	1084	4.49	924	5.22	806	6.24	642
L157Y	10	.34		1260	.66	1223	1.21	1121	1.70	1050	2.81	868	3.60	741	4.18	645	5.00	515
PA7536Y	6	.88		3261	1.66	3076	3.03	2807	4.17	2576	6.69	2066	8.38	1725	9.59	1481	11.21	1154
PA935Y	5	1.53	5670	2.88	5336	5.16	4781	7.01	4330	10.93	3375	13.44	2767	15.19	2346	17.45	1796	
PA4416Y	16	4:1	.06	296	.12	296	.24	296	.34	280	.61	251	.83	228	1.02	210	1.30	4178
PA6412Y	12		.17	840	.32	791	.61	754	.86	708	1.48	609	1.94	533	2.31	476	2.83	388
PA6410Y	10		.22	1087	.42	1038	.80	988	1.13	931	1.95	803	2.56	703	3.04	626	3.74	513
PA848Y	8		.43	2125	.83	2051	1.54	1902	2.15	1771	3.56	1466	4.56	1252	5.30	1091	6.33	869
PA948Y	8		.75	3706	1.43	3533	2.62	3236	3.64	2998	5.92	2438	7.50	2059	8.65	1781	10.21	1401
PA6616Y	16		6:1	.09	667	.17	630	.33	611	.48	593	.86	531	1.17	482	1.42	439	1.82
PA6612Y	12	.12		889	.23	852	.44	815	.63	778	1.13	698	1.54	634	1.88	581	2.40	494

Ratings are based on strength calculation. Basic Static Strength Rating, or for hand operation of above gears is approximately 3 times the 100 RPM rating.

*Torque (Lb. Ins.) Output Rating

HP (Input)

†RPM of Pinion

Steel Spiral Miter & Bevel Gears

Steel Spiral Miter Gears (1:1 Ratio)

LSA Series – Unhardened Steel

HLSK Series – Hardened Steel (Teeth Only)

APPROXIMATE HP & TORQUE* RATINGS FOR CLASS I SERVICE (Service Factor = 1.0)

Catalog Number	Pitch	50 RPM		100 RPM		200 RPM		300 RPM		600 RPM		900 RPM		1200 RPM		1800 RPM	
		HP	Torque	HP	Torque	HP	Torque	HP	Torque	HP	Torque	HP	Torque	HP	Torque	HP	Torque
LSA110Y	18	.01	12.4	.02	12.4	.04	12.4	.07	14.4	.14	14.4	.20	13.7	.25	12.9	.35	12.0
LSA101Y	12	.02	24.7	.04	24.7	.08	24.7	.13	26.8	.25	25.7	.35	24.0	.45	23.2	.62	21.3
LSA102Y	12	.03	37.1	.07	43.2	.13	40.1	.20	41.2	.38	39.1	.54	37.1	.63	32.4	.95	32.6
HLSK110Y	18	.03	37.1	.07	43.2	.14	43.2	.21	43.2	.42	43.2	.59	40.5	.76	39.1	1.0	34.3
HLSK101Y	12	.06	74.1	.13	80.3	.26	80.3	.39	80.3	.75	77.2	1.0	68.6	1.3	66.9	1.8	61.8
LSA103Y	10	.07	86.5	.15	92.6	.30	92.6	.44	90.6	.80	82.4	1.1	75.5	1.4	72.1	2.0	68.6
HLSK102Y	12	.10	124	.21	130	.41	127	.61	126	1.0	103	1.6	110	2.0	103	2.8	96.1
LSA104Y	10	.15	185	.30	185	.57	176	.83	171	1.5	154	2.0	137	2.6	134	3.6	124
LSA105YA	7	.22	272	.44	272	.84	259	1.2	247	2.2	226	3.0	206	3.8	196	5.1	175
HLSK103Y	10	.23	284	.46	284	.89	275	1.3	268	2.4	247	3.4	233	4.3	221	5.9	202
LSA106Y	8	.34	420	.69	426	1.3	401	1.8	371	3.3	340	4.5	309	5.7	293	7.8	268
LSA107Y	6	.46	568	.90	556	1.7	525	2.4	494	4.3	443	5.9	405	7.4	381	10.0	343
LSA118Y	6	.46	568	.90	556	1.7	525	2.4	494	4.3	443	5.9	405	7.4	381	10.0	343
HLSK104Y	10	.45	556	.90	556	1.7	525	2.5	515	4.5	463	6.1	419	7.9	407	11.1	381
HLSK105YA	7	.67	828	1.3	803	2.5	772	3.6	741	6.5	669	9.0	618	11.0	566	15.0	515
LSA122Y	5	.83	1025	1.6	988	3.0	926	4.3	885	7.5	772	10.0	686	12.0	618	17.0	583
HLSK106Y	8	1.0	1235	2.0	1235	3.9	1204	5.6	1153	10.0	1029	13.0	892	17.0	875	23.0	789
HLSK107Y	6	1.3	1606	2.7	1668	5.1	1575	7.3	1503	13.0	1338	17.0	1167	22.0	1132	33.0	1132
HLSK118Y	6	1.3	1606	2.7	1668	5.1	1575	7.3	1503	13.0	1338	17.0	1167	22.0	1132	33.0	1132
HLSK122Y	5	2.4	2965	4.9	3026	9.1	2810	13.1	2697	23.01	2378	30.0	2059	38.0	1956	51.0	1750

Steel Spiral Bevel Gears** (2:1 Ratio)

SS-Series – Unhardened Steel

SH Series – Hardened Steel (Teeth Only)

APPROXIMATE HP & TORQUE* RATINGS FOR CLASS I SERVICE (Service Factor = 1.0)

Catalog Number	Pitch	50 RPM†		100 RPM†		200 RPM†		300 RPM†		600 RPM†		900 RPM†		1200 RPM†		1800 RPM†	
		HP	Torque	HP	Torque	HP	Torque	HP	Torque	HP	Torque	HP	Torque	HP	Torque	HP	Torque
SS302	30	.002	4.9	.004	4.9	.008	4.9	.013	5.4	.025	5.1	.037	5.1	.05	5.1	.07	4.8
SH302	30	.005	12.4	.01	12.4	.02	12.4	.03	12.4	.06	12.4	.09	12.4	.12	12.4	.18	12.4
SS192	19	.01	24.7	.02	24.7	.04	24.7	.06	24.7	.12	24.7	.18	24.7	.24	24.7	.35	24.0
SS142	14	.02	49.4	.05	61.8	.09	55.6	.14	57.6	.26	53.5	.39	53.5	.51	52.5	.76	52.2
SH192	19	.03	74.1	.05	61.8	.10	61.8	.16	65.9	.31	63.8	.46	63.1	.60	61.8	.88	60.4
SS142-1	14	.04	98.8	.08	98.8	.16	98.8	.23	94.7	.45	92.6	.67	92.0	.88	90.6	1.3	89.2
SH142	14	.06	148	.12	148	.23	142	.34	140	.66	136	.98	135	1.3	134	1.9	130
SH142-1	14	.10	247	.20	247	.39	241	.58	239	1.1	226	1.7	233	2.2	226	3.2	220
SS102	10	.14	346	.27	334	.52	321	.78	321	1.5	309	2.2	302	2.9	299	4.3	295
SS82	8	.26	642	.50	618	.99	611	1.5	618	2.8	576	4.2	576	5.5	566	8.0	549
SH102	10	.34	840	.67	828	1.3	803	2.0	824	3.8	782	5.6	769	7.3	751	10.7	734
SH82	8	.64	1581	1.3	1606	2.5	1544	3.7	1524	7.1	1462	10.5	1441	13.7	1410	20.0	1373

Ratings are based on strength calculation. Basic Static Strength Rating, or for hand operation of above gears is approximately 3 times the 100 RPM rating.

*Torque (Lb. Ins.) Output Rating

HP (Input)

Note: Ratings to right of heavy line are not recommended, as pitch line velocity exceeds 1000 feet per minute. Use for interpolation purposes only.

**Ratings reflect Gear and Pinion sets.

†Pinion RPM



CATALOG NUMBERS / DIMENSIONS.....	86-95
SELECTION PROCEDURE.....	96
HORSEPOWER & TORQUE RATINGS.....	97-98
CENTER DISTANCES & RATIOS AVAILABLE.....	98
STOCK ALTERED / CUSTOM WORM AND WORM GEARS.....	3-5
WORM/WORM GEAR ENGINEERING INFORMATION	318-319

Worms & Worm Gears

48 Diametral Pitch (Bronze Worm Gears, Steel Worms – Unhardened & Hardened, Acetal Worm Gears & Worms)

Pressure Angle – Single thread 14-1/2° – Double thread 20° – Quad thread 25°



RATIO = Gear Teeth ÷ Worm Threads

All Worms and Worm Gears stocked RIGHT HAND ONLY.

ALL DIMENSIONS IN INCHES
ORDER BY CATALOG NUMBER OR ITEM CODE

48 DIAMETRAL PITCH		WORM GEARS				FACE = .156" *CENTER LINE WORM TO FLUSH END = .078"					
No. of Teeth	Pitch Dia.	Bore	Hub		Style See Page 323	SINGLE Thread		DOUBLE Thread		QUAD Thread	
			Dia.	Proj.		Catalog Number	Item Code	Catalog Number	Item Code	Catalog Number	Item Code
ACETAL**											
20	.417	.187	.34	.19	B	GP1018	54106	-	-	-	-
30	.625		.44	.25		GP1019	54107	-	-	-	-
40	.833		.50			GP1020	54108	-	-	-	-
50	1.042					GP1021	54109	-	-	-	-
ACETAL WITH BRASS INSERTS**											
20	.417	.125	.34	.19	B	GP1018-1/8	54118	-	-	-	-
30	.625	.125	.44	.25		GP1019-1/8	54119	-	-	-	-
		.188				GP1019-3/16	54120	-	-	-	-
40	.833	.188	.50	.25		GP1020-3/16	54121	-	-	-	-
		.250			GP1020-1/4	54122	-	-	-	-	
50	1.042	.188	.50	.25	GP1021-3/16	54123	-	-	-	-	
		.250			GP1021-1/4	54124	-	-	-	-	
BRONZE											
20	.417	.1875	.34	.19	A	G1018	13564	D1118	13488	Q1318	13440
30	.625		.44	.25		G1019	13566	D1119	13490	Q1319	13442
40	.833		.50			G1020	13568	D1120	13492	Q1320	13444
50	1.042		.50			G1021	13570	D1121	13494	Q1321	13446
60	1.250	.62	.31	B	G1024	13572	D1124	13500	Q1324	13452	
80	1.667	.62			G1022	13574	D1122	13496	Q1322	13448	
100	2.083	.69	G1023	13576	D1123	13498	Q1323	13450			

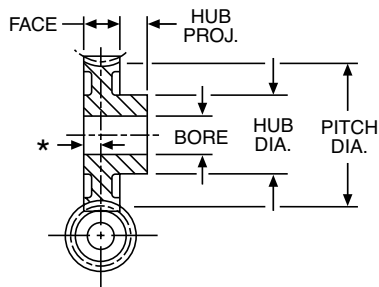

STANDARD TOLERANCES

DIMENSION		TOLERANCE	
BORE	Bronze and Steel	All	±.0005
	Acetal	All	+.001 –.002
	Acetal with Brass Insert	All	+.001 –.000

WORM LEAD and LEAD ANGLE

	SINGLE	DOUBLE	QUAD
LEAD	.0654"	.1309"	.2618"
LEAD ANGLE	3°35'	7°7'	14°2'

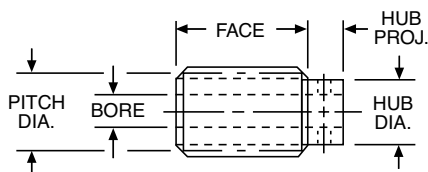

REFERENCE PAGES

Alterations – 322
Lubrication – 322
Materials – 323

48 DIAMETRAL PITCH		WORMS FOR ABOVE GEARS									
Pitch Dia.	Face	Bore	Hub		SINGLE Thread		DOUBLE Thread		QUAD Thread		
			Dia.	Proj.	Catalog Number	Item Code	Catalog Number	Item Code	Catalog Number	Item Code	
ACETAL											
.333	.562	.187	.26	.19	LSHP	54141	-	-	-	-	
UNHARDENED – STEEL											
.333	.562	.1875	.26	.19	LSH-1	12920	DSH-1	12928	QSH-1	12934	
HARDENED – STEEL											
.333	.562	.1875	.26	.19	HLSH-1	13026	HDSH-1	13052	HQSH-1	13062	
					GLSH-1	12952	GDSH-1	13036	GQSH-1	13042	

All Steel worms have .0625 drilled hole in hub.
Hxxx worms have polished threads.
Gxxx worms have ground and polished threads.

Worms & Worm Gears

32 Diametral Pitch (Bronze Worm Gears, Steel Worms – Unhardened & Hardened, Acetal Worm Gears & Worms)

Pressure Angle – Single thread 14-1/2° – Double thread 20° – Quad thread 25°

RATIO = Gear Teeth ÷ Worm Threads

All Worms and Worm Gears stocked RIGHT HAND ONLY.

ALL DIMENSIONS IN INCHES
ORDER BY CATALOG NUMBER OR ITEM CODE

32 DIAMETRAL PITCH					WORM GEARS		FACE = .219" *CENTER LINE WORM TO FLUSH END = .109"					
No. of Teeth	Pitch Dia.	Bore	Hub		Style See Page 323	SINGLE Thread		DOUBLE Thread		QUAD Thread		
			Dia.	Proj.		Catalog Number	Item Code	Catalog Number	Item Code	Catalog Number	Item Code	
ACETAL**												
20	.625	.187	.50	.25	B	GP1026	54110	-	-	-	-	
30	.938	.63	.25	GP1027		54111	-	-	-	-		
40	1.250	.63	.31	B	GP1028	54112	-	-	-	-		
50	1.562	.63	.31		GP1029	54113	-	-	-	-		
ACETAL WITH BRASS INSERTS**												
20	.625	.188	.50	.25	B	GP1026-3/16	54125	-	-	-	-	
		.250	.63	.25		GP1026-1/4	54126	-	-	-	-	
30	.938	.188	.63	.25	B	GP1027-3/16	54127	-	-	-	-	
		.250	.63	.25		GP1027-1/4	54128	-	-	-	-	
40	1.250	.250	.63	.31	B	GP1028-1/4	54129	-	-	-	-	
		.313	.63	.31		GP1028-5/16	54130	-	-	-	-	
50	1.562	.250	.63	.31	B	GP1029-1/4	54131	-	-	-	-	
		.3125	.63	.31		GP1029-5/16	54132	-	-	-	-	
BRONZE												
20	.625	.1875	.50	.25	A	G1026	13578	D1126	13502	Q1326	13454	
30	.938	.62	.25	G1027		13580	D1127	13504	Q1327	13456		
40	1.250	.62	.31	A	G1028	13582	D1128	13506	Q1328	13458		
50	1.562	.62	.31		G1029	13584	D1129	13508	Q1329	13460		
60	1.875	.69	.31	A	G1032	13586	D1132	13514	Q1332	13466		
80	2.500	.69	.31		D	G1030	13588	D1130	13510	Q1330	13462	
96	3.000	.3125	.69	G1031		13590	-	-	Q1331	13464		
100	3.125	.69	.31	G1033		13592	D1133	13516	-	-		

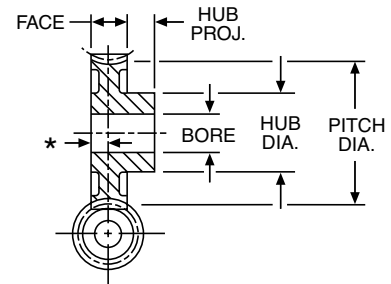

STANDARD TOLERANCES

DIMENSION		TOLERANCE	
BORE	Bronze and Steel	All	±.0005
	Acetal	All	+ .001 - .002
	Acetal with Brass Insert	All	+ .001 - .000

WORM LEAD and LEAD ANGLE

	SINGLE	DOUBLE	QUAD
LEAD	.0982"	.1963"	.3927"
LEAD ANGLE	4°5'	8°8'	15°57'

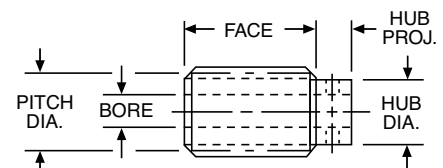

32 DIAMETRAL PITCH					WORMS FOR ABOVE GEARS					
Pitch Dia.	Face	Bore	Hub		SINGLE Thread		DOUBLE Thread		QUAD Thread	
			Dia.	Proj.	Catalog Number	Item Code	Catalog Number	Item Code	Catalog Number	Item Code
ACETAL										
.438	.641	.187	.32	.19	LTHBP	54142	-	-	-	-
UNHARDENED – STEEL										
.438	.688	.1875	.32	.19	LTHB-1	12922	DTH-1	12930	QTH-1	12936
HARDENED – STEEL										
.438	.688	.2187	.32	.19	HLTH-1	13028	HDTH-1	13054	HQTH-1	13064
					GLTH-1	12954	GDTH-1	13038	GQTH-1	13044

All Steel worms have .0625 drilled hole in hub.

Hxxx worms have polished threads.

Gxxx worms have ground and polished threads.

**These are in effect Helical Gears with a Helix Angle compatible with the worms. When in mesh they operate as a worm pair at right angles. Face Width is 3/16".

REFERENCE PAGES

Alterations – 322

Lubrication – 322

Materials – 323

Worms & Worm Gears

24 Diametral Pitch (Bronze Worm Gears, Steel Worms – Unhardened & Hardened, Minlon® Worm Gears – Nylon Worms)

Pressure Angle – Single thread 14-1/2° – Double thread 20° – Quad thread 25°

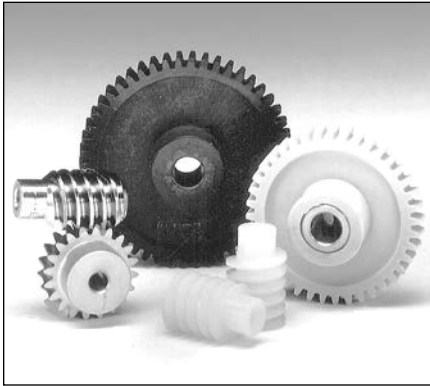

RATIO = Gear Teeth ÷ Worm Threads

All Worms and Worm Gears stocked RIGHT HAND ONLY.

ALL DIMENSIONS IN INCHES
ORDER BY CATALOG NUMBER OR ITEM CODE

24 DIAMETRAL PITCH		WORM GEARS				FACE = .250" *CENTER LINE WORM TO FLUSH END = .125"					
No. of Teeth	Pitch Dia.	Bore	Hub		Style See Page 323	SINGLE Thread		DOUBLE Thread		QUAD Thread	
			Di.	Proj.		Catalog Number	Item Code	Catalog Number	Item Code	Catalog Number	Item Code
MINLON**											
20	.833	.187	.63	.31	B	GP1034	54114	-	-	-	-
30	1.250	.250	.63	.31	B	GP1035	54115	-	-	-	-
40	1.667	.3125	.75	.31	B	GP1036	54116	-	-	-	-
50	2.083	.3125	.75	.31	B	GP1037	54117	-	-	-	-
MINLON WITH BRASS INSERTS**											
20	.833	.1875	.63	.31	B	GP1034-3/16	54133	-	-	-	-
		.250	.63	.31	B	GP1034-1/4	54134	-	-	-	-
30	1.250	.1875	.63	.31	B	GP1035-3/16	54135	-	-	-	-
		.250	.63	.31	B	GP1035-1/4	54136	-	-	-	-
40	1.667	.250	.75	.31	B	GP1036-1/4	54137	-	-	-	-
		.3125	.75	.31	B	GP1036-5/16	54138	-	-	-	-
50	2.083	.250	.75	.31	B	GP1037-1/4	54139	-	-	-	-
		.3125	.75	.31	B	GP1037-5/16	54140	-	-	-	-
BRONZE											
20	.833	.1875	.62	.31	A	G1034	13594	D1134	13518	Q1334	13470
30	1.250	.250	.62	.31	A	G1035	13596	D1135	13520	Q1335	13472
40	1.667	.250	.62	.31	A	G1036	13598	D1136	13522	Q1336	13474
50	2.083	.3125	.75	.31	B	G1037	13600	D1137	13524	Q1337	13476
60	2.500	.3125	.75	.31	C	G1040	13602	D1140	13530	Q1340	13482
72	3.000	.3125	.75	.31	C	G1038	13604	D1138	13526	Q1338	13478
80	3.333	.3125	.88	.38	D	G1041	13606	D1141	13532	Q1341	13484
96	4.000	.3125	.88	.38	D	G1039	13608	D1139	13528	-	-
100	4.167	.375	.88	.38	D	G1049	13610	D1149	13534	-	-

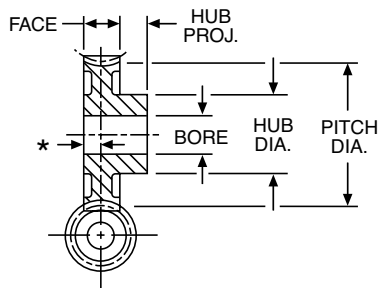

STANDARD TOLERANCES

DIMENSION		TOLERANCE	
BORE	Bronze and Steel	All	±.0005
	Minlon/Nylon	All	+ .001 - .002
	Minlon/Nylon w/Brass Insert	All	+ .001 - .000

WORM LEAD and LEAD ANGLE

	SINGLE	DOUBLE	QUAD
LEAD	.1309"	.2618"	.5236"
LEAD ANGLE	4°46'	9°28'	18°26'

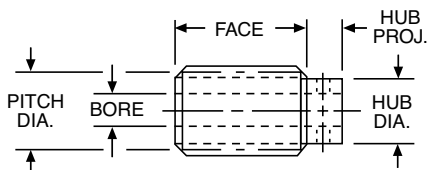

REFERENCE PAGES

Alterations — 322
Lubrication — 322
Materials — 323

24 DIAMETRAL PITCH		WORMS FOR ABOVE GEARS								
Pitch Dia.	Face	Bore	Hub		SINGLE Thread		DOUBLE Thread		QUAD Thread	
			Di.	Proj.	Catalog Number	Item Code	Catalog Number	Item Code	Catalog Number	Item Code
NYLON										
.500	.643	.187	.38	.25	LUHBP	54143	-	-	-	-
UNHARDENED - STEEL										
.500	.812	.1875	.38	.25	LUHB	12924	DUH	12932	QUH	12938
HARDENED - STEEL										
.500	.812	.25	.38	.25	HLUH	13030	HDUH	13056	HQUH	13066
					GLUH	12956	GDUH	13040	GQUH	13060

All Steel worms have .0938 drilled hole in hub.

Hxxx worms have polished threads.

Gxxx worms have ground and polished threads.

MINLON® is a registered trademark of E.I. DuPont.

**These are in effect Helical Gears with a Helix Angle compatible with the worms. When in mesh they operate as a worm pair at right angles.

Worms & Worm Gears

16 Diametral Pitch (Bronze & Cast Iron Worm Gears, Steel Worms – Unhardened & Hardened)

Pressure Angle – Single thread 14-1/2° – Double thread 14-1/2° – Quad thread 25°

RATIO = Gear Teeth ÷ Worm Threads

All Worms and Worm Gears stocked RIGHT HAND ONLY.

ALL DIMENSIONS IN INCHES
ORDER BY CATALOG NUMBER OR ITEM CODE

16 DIAMETRAL PITCH		WORM GEARS				FACE = .313" *CENTER LINE WORM TO FLUSH END = .156"					
No. of Teeth	Pitch Dia.	Bore	Hub		Style See Page 323	SINGLE Thread		DOUBLE Thread		QUAD Thread	
			Dia.	Proj.		Catalog Number	Item Code	Catalog Number	Item Code	Catalog Number	Item Code
BRONZE											
20	1.250	.250	.62	.31	A	G1042	13612	D1142	13700	Q1342	13536
30	1.875	.3125	.75	.38	B	G1043	13614	D1143	13702	Q1343	13538
40	2.500				C	G1044	13616	D1144	13704	Q1344	13540
50	3.125	.375	.88	.44	D	G1045	13618	D1145	13706	Q1345	13542
60	3.750					G1048	13620	D1148	13708	Q1348	13544
80	5.000					G1046	13622	-	-	Q1346	13546
100	6.250					G1047	13624	-	-	-	-
CAST IRON											
20	1.250	.250	.62	.31	A	CG1042	63506	CD1142	63513	CQ1342	63518
30	1.875	.3125	.75	.38	B	CG1043	63507	CD1143	63514	CQ1343	63519
40	2.500				C	CG1044	63508	CD1144	63515	CQ1344	63520
50	3.125	.375	.88	.44	C	CG1045	63509	CD1145	63516	CQ1345	63521
60	3.750					CG1048	63510	CD1148	63517	CQ1348	63522
80	5.000					CG1046	63511	-	-	CQ1346	63523
100	6.250					CG1047	63512	-	-	-	-

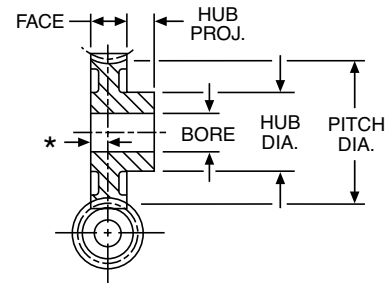

STANDARD TOLERANCES

DIMENSION	TOLERANCE
BORE	All ±.0005

WORM LEAD and LEAD ANGLE

	SINGLE	DOUBLE	QUAD
LEAD	.1963"	.3927"	.7854"
LEAD ANGLE	5°43'	11°19'	21°48'

16 DIAMETRAL PITCH		WORMS FOR ABOVE GEARS									
Pitch Dia.	Face	Bore	Hub		SINGLE Thread		DOUBLE Thread		QUAD Thread		
			Dia.	Proj.	Catalog Number	Item Code	Catalog Number	Item Code	Catalog Number	Item Code	
UNHARDENED – STEEL											
.625	1.00	.250	.44	.25	LVHB-1	12926	DVH-1	12862	QVH-1	12940	
HARDENED – STEEL											
.625	1.00	.3125	.44	.25	HLVH-1	13032	HVH-1	13004	HQVH-1	13058	
					GLVH-1	12958	GDVH-1	12950	GQVH-1	13046	

All worms have .0938 drilled hole in hub.
Hxxx worms have polished threads.
Gxxx worms have ground and polished threads.

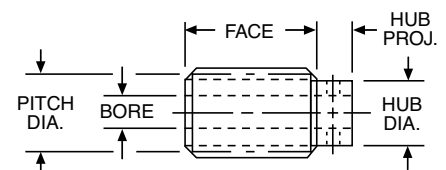

REFERENCE PAGES

Alterations – 322
Lubrication – 322
Materials – 323

Worms & Worm Gears

12 Diametral Pitch (Bronze & Cast Iron Worm Gears, Steel Worms – Unhardened & Hardened)

Pressure Angle – 14-1/2°

RATIO = Gear Teeth ÷ Worm Threads
RH = RIGHT HAND — LH = LEFT HAND
All others stocked RIGHT HAND ONLY.

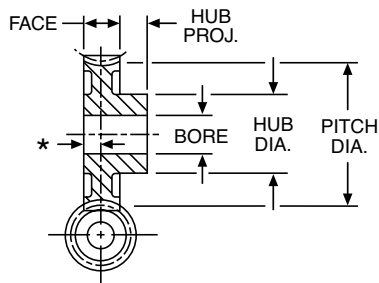

STANDARD TOLERANCES

DIMENSION		TOLERANCE
BORE	All	±.0005

WORM LEAD and LEAD ANGLE

	SINGLE	DOUBLE	QUAD
LEAD	.2618"	.5236"	1.0472"
LEAD ANGLE	4°46'	9°28'	18°26'

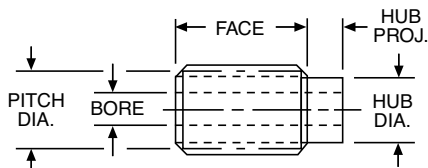

REFERENCE PAGES

- Alterations — 322
- Horsepower Ratings — 97, 98
- Lubrication — 322
- Materials — 323
- Selection Procedure — 96

ALL DIMENSIONS IN INCHES
ORDER BY CATALOG NUMBER OR ITEM CODE

12 DIAMETRAL PITCH		WORM GEARS				FACE = .500" *CENTER LINE WORM TO FLUSH END = .250"					
No. of Teeth	Pitch Dia.	Bore	Hub		Style See Page 323	SINGLE Thread		DOUBLE Thread		QUAD Thread	
			Dia.	Proj.		Catalog Number	Item Code	Catalog Number	Item Code	Catalog Number	Item Code
BRONZE											
12	1.000	.5625	1.00	.62	A	-	-	-	-	QB1212†	13762
16	1.333	.6875	1.25	.62		-	-	-	-	QB1216†	13764
20	1.667	.500	1.25	.50		GB1050A	13626	DB1400	13714	DB1600	13766
30	2.500	.500	1.19	.62	B	GB1051	13628	-	-	-	-
		.750		.62		-	-	DB1401A	13716	DB1601A	13768
40	3.333	.625	1.44	.62		GB1052A	13630	-	-	-	-
		.750		.62		-	-	DB1402A	13718	DB1602A	13770
50	4.167	.625	1.44	.62		GB1053A	13632	-	-	-	-
		.750		.62		-	-	DB1403A	13720	DB1603A	13772
60	5.000	.625	1.69	.62	C	GB1260A	13634	-	-	-	-
		.750		.62		-	-	DB1260A	13722	QB1260A	13774
80	6.667	.625	1.94	.75		GB1054	13636	-	-	-	-
100	8.333	.750	1.94	.75	GB1055	13638	-	-	-	-	
CAST IRON											
20	1.667	.500	1.25	.50	A	G1050ARH	13110	D1400RH	13260	D1600	13352
		.500		.62		G1050ALH	13112	D1400LH	13262	-	-
30	2.500	.750	1.19	.62		G1051RH	13114	-	-	-	-
					G1051LH	13116	D1401ARH	13264	D1601A	13354	
					-	-	D1401ALH	13266	-	-	
40	3.333	.625	1.44	.62	B	G1052ARH	13118	-	-	-	-
		.750		.62		G1052ALH	13120	-	-	-	-
						-	-	D1402ARH	13268	D1602A	13356
						-	-	D1402ALH	13270	-	-
50	4.167	.625	1.44	.62		G1053ARH	13122	-	-	-	-
		.750		.62		G1053ALH	13124	-	-	-	-
60	5.000	.625	1.69	.75	C	-	-	D1403ARH	13272	D1603A	13358
		.750		.62		-	-	D1403ALH	13274	-	-
						G1260RH	13126	-	-	-	-
					G1260LH	13128	-	-	-	-	
80	6.667	.625	1.94	.75	-	-	D1260A	13276	Q1260A	13360	
		.750		.75	G1054	13130	-	-	-	-	
100	8.333	.750	1.94	.75	-	-	D1404	13278	-	-	
					G1055	13134	-	-	-	-	

12 DIAMETRAL PITCH		WORMS FOR ABOVE GEARS									
Pitch Dia.	Face	Bore	Hub		SINGLE Thread		DOUBLE Thread		QUAD Thread		
			Dia.	Proj.	Catalog Number	Item Code	Catalog Number	Item Code	Catalog Number	Item Code	
UNHARDENED - STEEL											
1.000	1.125	.625	-	-	-	-	D1407KRH‡	12806	D1607KRH‡	12822	
		.625	-	-	-	-	D1407KLH‡	12808	D1607KLH‡	12824	
	1.625	.500	-	-	L1056‡	12900	L1407‡	12912	-	-	
	1.125	.500	.75	.38	GH1056RH	12884	DH1407RH	12838	DH1607	12854	
					GH1056LH	12886	DH1407LH	12840	-	-	
HARDENED - STEEL											
1.000	1.125	.625	-	-	-	-	H1407RH‡	12980	H1607‡	12996	
		.625	-	-	-	-	H1407LH‡	12982	-	-	
	1.625	.500	-	-	HL1056‡	13006	HL1407‡	13018	-	-	
		1.125	.500	-	-	H1056RH‡	12962	-	-	-	
					H1056LH‡	12960	-	-	-	-	

‡.750" Face, Center Line Worm to Flush End = .375"
‡Furnished with .125" Keyway.
Hardened Worms have ground and polished threads.

Worms & Worm Gears

10 Diametral Pitch (Bronze & Cast Iron Worm Gears, Steel Worms – Unhardened & Hardened)

Pressure Angle – 14-1/2°

RATIO = Gear Teeth ÷ Worm Threads
RH = RIGHT HAND – LH = LEFT HAND
All others stocked RIGHT HAND ONLY.

ALL DIMENSIONS IN INCHES
ORDER BY CATALOG NUMBER OR ITEM CODE

10 DIAMETRAL PITCH		WORM GEARS					FACE = .625" *CENTER LINE WORM TO FLUSH END = .312"				
No. of Teeth	Pitch Dia.	Bore	Hub		Style See Page 323	SINGLE Thread		DOUBLE Thread		QUAD Thread	
			Dia.	Proj.		Catalog Number	Item Code	Catalog Number	Item Code	Catalog Number	Item Code
BRONZE											
16	1.600	.750	1.50	.75	A	-	-	-	-	QB1016†	13780
20	2.000	.500 .875	1.25 1.62	.62		GB1060A	13640	-	-	-	-
30	3.000	.625 .875	1.69	.62	B	-	-	DB1410	13728	DB1610	13782
40	4.000	.625 .875	1.69	.62		GB1061A	13648	-	-	-	-
50	5.000	.750 .875	1.94	.75	GB1062A	13642	-	-	-	-	-
60	6.000	.750 .875	1.94	.75	-	-	DB1411	13736	DB1611	13788	-
80	8.000	.750	1.94	.75	GB1063	13644	-	-	-	-	-
100	10.000	.750	2.00	.75	-	-	DB1412	13730	DB1612	13784	-
					C	GB1064	13646	-	-	-	-
						GB1067	13650	-	-	-	-
					GB1065	13652	-	-	-	-	-
CAST IRON											
20	2.000	.500 .875	1.25 1.62	.62	A	G1060ARH G1060ALH	13136 13138	-	-	-	-
30	3.000	.625 .875	1.69 1.69	.62		-	-	D1410RH D1410LH	13282 13284	D1610	13366
40	4.000	.625 .875	1.69 1.69	.62	B	G1061ARH G1061ALH	13142 13140	-	-	-	-
50	5.000	.750 .875	1.94 1.94	.75		-	-	D1411RH D1411LH	13286 13288	D1611	13368
60	6.000	.750 .875	1.94 1.94	.75	C	G1062ARH G1062ALH	13144 13146	-	-	-	-
80	8.000	.750 .875	1.94 1.94	.75		-	-	D1412RH D1412LH	13290 13292	D1612	13370
100	10.000	.750 .875	1.94 1.94	.75	-	-	D1413ARH D1413ALH	13294 13296	D1613A	13372	-
					C	G1063RH G1063LH	13148 13150	-	-	-	-
						-	-	D1414A	13298	D1614A	13374
					C	G1064RH G1064LH	13152 13154	-	-	-	-
						G1067RH	13156	-	-	-	-
					-	-	D1080A	13300	Q1080A	13376	-
					-	-	D1415A	13302	-	-	-

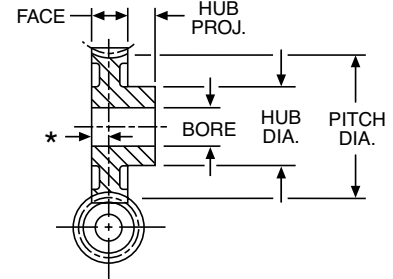

STANDARD TOLERANCES

DIMENSION	TOLERANCE
BORE	All ±.0005

WORM LEAD and LEAD ANGLE

	SINGLE	DOUBLE	QUAD
LEAD	.3142"	.6283"	1.2566"
LEAD ANGLE	4°34'	9°5'	17°45'

10 DIAMETRAL PITCH		WORMS FOR ABOVE GEARS									
Pitch Dia.	Face	Bore	Hub		SINGLE Thread		DOUBLE Thread		QUAD Thread		
			Dia.	Proj.	Catalog Number	Item Code	Catalog Number	Item Code	Catalog Number	Item Code	
UNHARDENED – STEEL											
1.250	1.375	.750	-	-	-	-	D1418KRH‡	12810	D1618KRH‡	12826	
	2.000	.750	-	-	-	-	D1418KLH‡	12812	D1618KLH‡	12828	
		.625	-	-	L1066‡	12902	-	-	-	-	
	1.375	.625	-	-	G1066KRH‡	12864	-	-	-	-	
			.97	.50	G1066KLH‡	12866	-	-	-	-	
					G1066RH‡	12888	DH1418RH	12842	DH1618	12856	
					G1066LH‡	12890	DH1418LH	12844	-	-	
HARDENED STEEL											
1.250	1.375	.750	-	-	-	-	H1418RH‡	12986	H1618‡	12998	
	2.000	.750	-	-	-	-	H1418LH‡	12984	-	-	
		.625	-	-	HL1066‡	13008	-	-	-	-	
	1.375	.625	-	-	H1066RH‡	12966	-	-	-	-	
					H1066LH‡	12964	-	-	-	-	

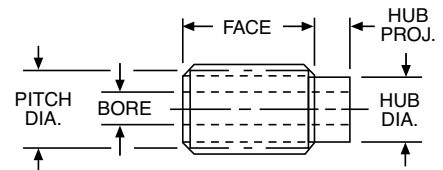

REFERENCE PAGES

Alterations – 322
Horsepower Ratings – 97, 98
Lubrication – 322
Materials – 323
Selection Procedure – 96

Worms & Worm Gears

8 Diametral Pitch (Bronze & Cast Iron Worm Gears, Steel Worms – Unhardened & Hardened)

Pressure Angle – 14-1/2°

RATIO = Gear Teeth ÷ Worm Threads
RH = RIGHT HAND — LH = LEFT HAND
All others stocked RIGHT HAND ONLY.

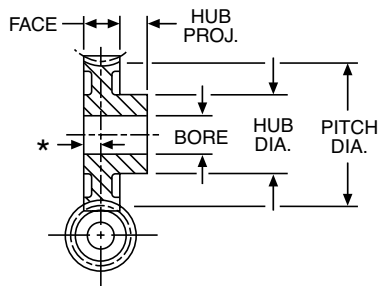

STANDARD TOLERANCES

DIMENSION	TOLERANCE
BORE	All ±.0005

WORM LEAD and LEAD ANGLE

	SINGLE	DOUBLE	QUAD
LEAD	.3927"	.7854"	1.5708"
LEAD ANGLE	4°46'	9°28'	18°26'

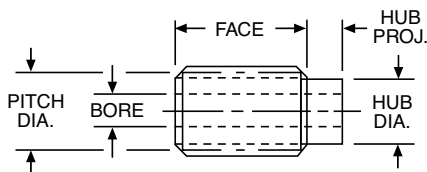

REFERENCE PAGES

- Alterations — 322
- Horsepower Ratings — 97, 98
- Lubrication — 322
- Materials — 323
- Selection Procedure — 96

ALL DIMENSIONS IN INCHES
ORDER BY CATALOG NUMBER OR ITEM CODE

8 DIAMETRAL PITCH		WORM GEARS				FACE = .750" *CENTER LINE WORM TO FLUSH END = .375"					
No. of Teeth	Pitch Dia.	Bore	Hub		Style See Page 323	SINGLE Thread		DOUBLE Thread		QUAD Thread	
			Dia.	Proj.		Catalog Number	Item Code	Catalog Number	Item Code	Catalog Number	Item Code
BRONZE											
8	1.000	.500	1.12	.88	A	—	—	—	—	QB808†	13790
12	1.500	.750	1.50	.88		—	—	—	—	QB812†	13792
16	2.000	1.000	2.00	.88		—	—	—	—	QB816†	13794
20	2.500	.750	1.75	.75	B	GB1070	13654	—	—	—	—
		1.000	1.75	.75		—	—	DB1420A	13740	DB1620A	13796
30	3.750	.750	1.69	.75	B	GB1071	13656	—	—	—	—
		1.000	1.69	.75		—	—	DB1421A	13742	DB1621A	13798
40	5.000	1.000	2.19	.75	C	GB1072A	13658	DB1422	13744	DB1622	13800
48	6.000	1.000	2.38	.88		GB1073	13660	—	—	—	—
50	6.250	1.000	2.31	.88	C	GB850	13662	DB1423A	13746	DB1623A	13802
60	7.500	1.000	2.44	.88		GB860	13664	DB860A	13748	—	—
80	10.000	1.250	2.75	.88	D	GB1074A	13666	—	—	—	—
100	12.500	1.250	3.00	1.00	C	GB8100	13668	—	—	—	—
CAST IRON											
20	2.500	.750	1.75	.75	A	G1070RH	13160	—	—	—	—
		1.000	1.75	.75		G1070LH	13162	—	—	—	—
30	3.750	.750	1.69	.75	B	G1071RH	13164	—	—	—	—
		1.000	1.69	.75		G1071LH	13166	—	—	—	—
40	5.000	1.000	1.69	.75	B	G1072ARH	13168	D1420ARH	13304	D1620A	13380
						G1072ALH	13170	D1420ALH	13306	D1620A	13380
48	6.000	1.000	2.38	.88	B	G1073RH	13174	D1421ARH	13308	D1621A	13382
						G1073LH	13172	D1421ALH	13310	D1621A	13382
50	6.250	1.000	2.31	.88	B	G1072ARH	13168	D1422ARH	13312	D1622A	13384
						G1072ALH	13170	D1422ALH	13314	D1622A	13384
60	7.500	1.000	2.44	.88	C	G850RH	13176	—	—	—	—
						G850LH	13178	D1423A	13316	D1623A	13386
80	10.000	1.250	2.69	.88	D	G860	13180	D860A	13320	Q860A	13388
96	12.000	1.250	3.00	1.00	C	—	—	D1424A	13322	D1624A	13390
						G1074ARH	13182	—	—	—	—
100	12.500	1.250	2.69	1.00	C	G1075	13186	—	—	—	—
						G8100A	13188	—	—	—	—

8 DIAMETRAL PITCH		WORMS FOR ABOVE GEARS										
Pitch Dia.	Face	Bore	Hub		SINGLE Thread		DOUBLE Thread		QUAD Thread			
			Dia.	Proj.	Catalog Number	Item Code	Catalog Number	Item Code	Catalog Number	Item Code		
UNHARDENED – STEEL												
1.500	1.750	.875	—	—	—	—	D1427KRH‡	12814	D1627KRH‡	12830		
	2.500	.875	—	—	—	—	D1427KLH‡	12816	D1627KLH‡	12832		
		.750	—	—	L1076‡	12904	—	—	—	—		
	1.750	.750	—	—	G1076KRH‡	12868	—	—	—	—		
.750		1.18	.62	G1076KLH‡	12870	—	—	—	—			
1.500	1.750	.750	—	—	—	—	GH1076RH	12892	DH1427RH	12846	DH1627	12858
							GH1076LH	12894	DH1427LH	12848	—	—
HARDENED STEEL												
1.500	1.750	.875	—	—	—	—	H1427RH‡	12990	H1627‡	13000		
	2.500	.875	—	—	—	—	H1427LH‡	12988	—	—		
		.750	—	—	HL1076‡	13010	—	—	—	—		
	1.750	.750	—	—	—	—	—	H1076RH‡	12970	—	—	
H1076LH‡								12968	—	—	—	—

†1.000" Face, Center Line Worm to Flush End = .500"
‡Furnished with .188" Keyway.
Hardened Worms have ground and polished threads.

Worms & Worm Gears

6 Diametral Pitch (Bronze & Cast Iron Worm Gears, Steel Worms – Unhardened & Hardened)

Pressure Angle – 14-1/2°

ALL DIMENSIONS IN INCHES
ORDER BY CATALOG NUMBER OR ITEM CODE

6 DIAMETRAL PITCH						WORM GEARS				FACE = 1.000" *CENTER LINE WORM TO FLUSH END = .500"		
No. of Teeth	Pitch Dia.	Bore	Hub		Style See Page 323	SINGLE Thread		DOUBLE Thread		QUAD Thread		
			Dia.	Proj.		Catalog Number	Item Code	Catalog Number	Item Code	Catalog Number	Item Code	
BRONZE												
16	2.667	1.250	2.38	1.00	A	-	-	-	-	QB616**	13804	
20	3.333	.750 1.000 1.250	2.00 2.00 2.00	.88		GB1077A	13670	-	-	DB620A	13752	-
24	4.000	.750 1.250	1.94	.88	B	GB1080A	13672	-	-	-	-	
30	5.000	.875 1.250	2.19	.88		GB1081	13674	-	-	-	-	-
36	6.000	1.000	2.50	.88	GB1082	13676	-	-	-	-	-	
40	6.667	1.000 1.250	2.44	.88	GB1078	13678	-	-	-	-	-	
48	8.000	1.250	2.75	1.00	C	GB1083	13680	-	-	-	-	
50	8.333	1.250	2.69	1.00		GB1079	13682	-	-	-	-	-
60	10.000	1.250	3.00	1.00		GB1087	13684	-	-	-	-	-
72	12.000	1.250	3.00	1.25		GB1084	13686	-	-	-	-	-
CAST IRON												
20	3.333	.750	1.81	.88	B	G1077RH	13190	-	-	-	-	-
		1.000				G1077LH	13192	-	-	-	-	-
24	4.000	.750	1.94	.88		G1080ARH	13194	-	-	-	-	-
		1.250				G1080ALH	13196	-	-	-	-	-
30	5.000	.875	2.19	.88		G1081RH	13198	-	-	-	-	-
		1.250				G1081LH	13200	-	-	-	-	-
36	6.000	1.000	2.50	.88		G1082RH	13202	-	-	-	-	-
		1.250				G1082LH	13204	-	-	-	-	-
40	6.667	1.000	2.44	.88		G1078RH	13206	-	-	-	-	-
		1.250				G1078LH	13208	-	-	-	-	-
48	8.000	1.250	2.75	1.00		G1083RH	13212	-	-	-	-	-
		1.500				G1083LH	13210	-	-	-	-	-
50	8.333	1.250	2.69	1.00	G1079RH	13214	D1433	13342	D1633	13402	-	
60	10.000	1.250	2.69	1.00	G1087ARH	13218	D660	13344	Q660	13404	-	
72	12.000	1.250	2.94	1.00	G1084ARH	13220	D1434	13346	D1634	13406	-	
80	13.333	1.250	3.00	1.00	G1088ARH	13224	-	-	-	-	-	
96	16.000	1.375	3.00	1.00	G1085ARH	13226	-	-	-	-	-	
100	16.667	1.375	3.00	1.00	D	G1089ARH	13228	-	-	-	-	

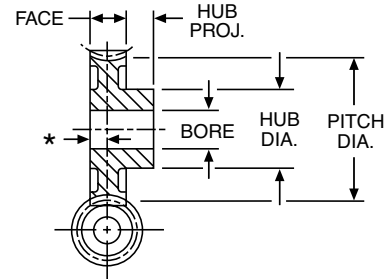

STANDARD TOLERANCES

DIMENSION	TOLERANCE
BORE	All ±.0005

WORM LEAD and LEAD ANGLE

	SINGLE	DOUBLE	QUAD
LEAD	.5236"	1.0472"	2.0944"
LEAD ANGLE	4°46'	9°28'	18°26'

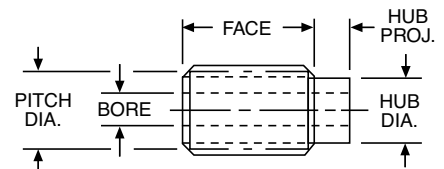

REFERENCE PAGES

Alterations — 322
Horsepower Ratings — 97, 98
Lubrication — 322
Materials — 323
Selection Procedure — 96

RATIO = Gear Teeth ÷ Worm Threads
RH = RIGHT HAND — LH = LEFT HAND
All others stocked RIGHT HAND ONLY.

**1.250" Face, Center Line Worm to Flush End = .625"
‡Furnished with .188" Keyway.
†Furnished with .250" Keyway.
Hardened Worms have ground and polished threads.

6 DIAMETRAL PITCH						WORMS FOR ABOVE GEARS					
Pitch Dia.	Face	Bore	Hub		Style See Page 323	SINGLE Thread		DOUBLE Thread		QUAD Thread	
			Dia.	Proj.		Catalog Number	Item Code	Catalog Number	Item Code	Catalog Number	Item Code
UNHARDENED — STEEL											
2.000	2.500	1.000	-	-	-	-	-	D1438KRH†	12818	D1638KRH†	12834
			-	-		D1438KLH†	12820	D1638KLH†	12836		
	3.500	1.000	-	-		-	-	L1438	12918	-	-
		.875	-	-		L1086‡	12906	-	-	-	-
2.500	.875	1.56	.75	G1086KRH‡	12872	-	-	-	-	-	
				G1086KLH‡	12874	-	-	-	-		
					GH1086RH	12896	DH1438RH	12850	DH1638	12860	
					GH1086LH	12898	DH1438LH	12852	-	-	
HARDENED STEEL											
2.000	2.500	1.000	-	-	-	-	-	H1438RH†	12994	H1638†	13002
			-	-		H1438LH‡	12992	-	-		
	3.500	1.000	-	-		-	-	HL1438†	13024	-	-
		.875	-	-		HL1086‡	13012	-	-	-	-
2.500	.875	-	-	H1086RH‡	12974	-	-	-	-		
				H1086LH‡	12972	-	-	-	-		

Worms & Worm Gears

4 Diametral Pitch (Bronze & Cast Iron Worm Gears, Steel Worms – Unhardened & Hardened)

Pressure Angle – 14-1/2°

RATIO = Gear Teeth ÷ Worm Threads
 RH = RIGHT HAND – LH = LEFT HAND
 All others stocked RIGHT HAND ONLY.

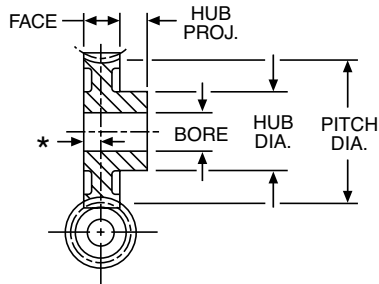

STANDARD TOLERANCES

DIMENSION		TOLERANCE
BORE	All	±.0005

WORM LEAD and LEAD ANGLE

LEAD	.7854
LEAD ANGLE	4°46'

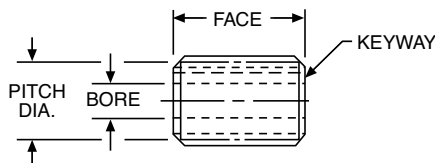

REFERENCE PAGES

Alterations – 322
 Horsepower Ratings – 97, 98
 Lubrication – 322
 Materials – 323
 Selection Procedure – 96

ALL DIMENSIONS IN INCHES
 ORDER BY CATALOG NUMBER OR ITEM CODE

4		FACE = 1.500"		*CENTER LINE WORM TO FLUSH END = .750"		WORM GEARS	
DIAMETRAL PITCH				Hub		SINGLE Thread	
No. of Teeth	Pitch Dia.	Bore	Dia.	Proj.	Style See Page 323	Catalog Number	Item Code
BRONZE							
20	5.000	1.000	2.50	1.25	B	GB1100	13688
24	6.000					GB1101	13690
CAST IRON							
20	5.000	1.000	2.50	1.25	B	G1100RH	13230
						G1100LH	13232
24	6.000					G1101RH	13234
						G1101LH	13236
32	8.000	1.250	3.00		B	G1102RH	13238
						G1102LH	13240
40	10.000					G1103RH	13242
48	12.000	1.500	3.50		D	G1104RH	13244
64	16.000					G1105RH	13246

4		WORMS FOR ABOVE GEARS		DIAMETRAL PITCH		SINGLE Thread	
Pitch Dia.	Face	Bore	Dia.	Proj.	Catalog Number*	Item Code	
UNHARDENED – STEEL							
3.000	3.500	1.250	-	-	G1106KRH	12876	
	4.500	1.250	-	-	G1106KLH	12878	
					L1106	12908	
HARDENED STEEL							
3.000	3.500	1.250	-	-	H1106	12976	
	4.500				HL1106	13014	
	5.750	1.250	-	-	HP1106	13034	

*All worms furnished with .313 keyway.
 Hardened Worms have ground and polished threads.

Worms & Worm Gears

3 Diametral Pitch (Cast Iron Worm Gears, Steel Worms – Unhardened & Hardened)

Pressure Angle – 14-1/2°

RATIO = Gear Teeth ÷ Worm Threads
All Worm and Worm Gears stocked RIGHT HAND ONLY.



ALL DIMENSIONS IN INCHES
ORDER BY CATALOG NUMBER OR ITEM CODE

3 DIAMETRAL PITCH WORM GEARS							
FACE = 2.000" *CENTER LINE WORM TO FLUSH END = 1.000"							
No. of Teeth	Pitch Dia.	Bore	Hub		Style See Page 323	SINGLE Thread	
			Dia.	Proj.		Catalog Number	Item Code
18	6.000	1.000	3.00	1.50	B	G1110	13248
24	8.000	1.500	3.50	1.50		G1111	13250
30	10.000					G1112	13252
36	12.000					G1113	13254
48	16.000	4.00			C	G1114	13256
54	18.000				D	G1115	13258

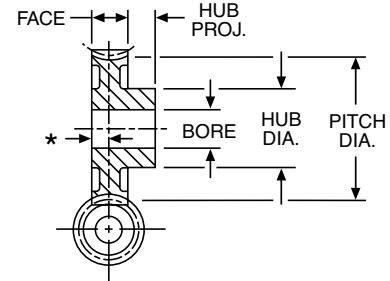

STANDARD TOLERANCES

DIMENSION	TOLERANCE
BORE	All ±.0005

3 WORMS FOR ABOVE GEARS† DIAMETRAL PITCH						
Pitch Dia.	Face	Bore	Hub		SINGLE Thread	
			Dia.	Proj.	Catalog Number	Item Code
UNHARDENED – STEEL						
4.000	4.000	1.500	-	-	G1116KRH	12880
	5.500				L1116	12910
HARDENED STEEL						
4.000	4.000	1.500	-	-	H1116	12978
	5.500				HL1116	13016

WORM LEAD and LEAD ANGLE

LEAD	1.0472"
LEAD ANGLE	4°46'

†All worms furnished with .375" keyway.
Hardened Worms have ground and polished threads.

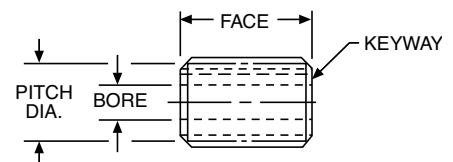

REFERENCE PAGES

Alterations – 322
Horsepower Ratings – 97, 98
Lubrication – 322
Materials – 323
Selection Procedure – 96

Worms & Worm Gears



Boston worms and worm gears provide an effective answer for such power transmission applications as high-ratio speed reduction, limited space, right-angle shafts and non-intersecting shafts. When properly applied, they are the smoothest and quietest form of gearing. Steel worms and cast iron or bronze worm gears are available in single, double or quadruple threads, 48 to 3 diametral pitch.

Acetal worms and worm gears are available in single thread, 48 to 24 diametral pitch.

Selection Procedure

Approximate input horsepower and output torque ratings for Boston stock worm and worm gear combinations from 12 to 3 DP are listed on Pages 97, 98. These ratings are for hardened, ground and polished worms operating with bronze worm gears. For other combinations multiply the listed ratings by the following percentages:

Hardened, ground and polished steel worms with cast iron gears 50%. Unhardened steel worms with cast iron gears 25%.

These ratings are listed at selected worm speeds. Ratings for intermediate speeds can be interpolated from the values indicated.

These ratings are based on gears operating with a Service Factor of 1.0, properly mounted in accordance with good design practice and continuously lubricated with a sufficient supply of oil.

1. Determine service factor.
 - a. Using Application Classification Chart I, pages 331, 332, determine service factor or
 - b. With knowledge of operating conditions and load classification, select service factor from Table 1.

2. Determine Design Horsepower.

Design HP = Application Load x Service Factor (Table 1)

3. Select worm gear set with horsepower capacity equal to [or greater than] design horsepower determined in Step 2.

TABLE 1

Service Factor	Operating Conditions
0.8	Uniform—not more than 15 minutes in 2 hours.
1.0	Moderate Shock—not more than 15 minutes in 2 hours. Uniform—not more than 10 hours per day.
1.25	Moderate Shock—not more than 10 hours per day. Uniform—more than 10 hours per day.
1.50	Heavy Shock—not more than 15 minutes in 2 hours. Moderate Shock—more than 10 hours per day.
1.75	Heavy Shock—not more than 10 hours per day.
2.0	Heavy Shock—more than 10 hours per day.

Heavy shock loads and/or severe wear conditions may require the use of higher service factors. Consultation with factory is recommended in these applications.

Worms & Worm Gears

Steel-Hardened, Ground & Polished Worms Bronze Worm Gears

Approximate Horsepower and Torque* Ratings
For Class I Service (Service Factor = 1.0)

Worm RPM		1800		600		100		Worm Cat. No.	Gear Cat. No.	DP
Ratio	Center Distance	Input HP	Output Torque	Input HP	Output Torque	Input HP	Output Torque			
3	1.000	.52	50	.27	72	.06	83	H1607	QB1212	12
	1.500	1.19	109	.66	183	.15	227	H1627	QB812	8
4	1.167	.78	99	.40	143	.08	166	H1607	QB1216	12
	1.425	1.11	142	.61	223	.13	267	H1618	QB1016	10
	1.750	1.77	216	.98	361	.22	454	H1627	QB816	8
	2.333	3.01	392	1.84	689	.45	933	H1638	QB616	6
5	1.333	.68	109	.34	158	.07	180	H1607	DB1600	12
	1.625	1.03	165	.57	257	.12	309	H1618	DB1610	10
	2.000	1.73	264	.96	441	.22	551	H1627	DB1620A	8
	2.667	3.92	639	2.40	1124	.59	1512	H1638	QB620A	6
6	3.000	3.82	746	2.34	1317	.57	1777	H1638	DB1630A	6
7.5	1.750	1.04	247	.53	355	.11	411	H1607	DB1601A	12
	2.125	1.59	381	.87	599	.19	714	H1618	DB1611	10
	2.625	2.65	607	1.47	1016	.33	1276	H1627	DB1621A	8
	3.500	4.80	1174	2.94	2064	.72	2789	H1638	DB1631A	6
10	1.333	.44	130	.23	189	.05	208	H1407	DB1400	12
	1.625	.67	196	.38	305	.09	366	H1418	DB1410	10
	2.000	1.05	318	.63	525	.15	649	H1427	DB1420A	8
	2.167	1.39	441	.71	641	.15	756	H1607	DB1602A	12
	2.667	2.01	616	1.26	1071	.32	1450	H1438	DB620A	6
	2.625	2.11	672	1.16	1061	.25	1267	H1618	DB1612	10
	3.250	3.54	1082	1.96	1806	.44	2270	H1627	DB1622	8
4.333	6.43	2094	3.94	3685	.96	4980	H1638	DB1632A	6	
12	3.000	2.39	882	1.50	1537	.38	2042	H1438	DB1430A	6
12.5	2.583	1.72	683	.87	985	.18	1134	H1607	DB1603A	12
	3.125	2.61	1042	1.44	1641	.31	1961	H1618	DB1613A	10
	3.875	4.40	1681	2.44	2810	.55	3466	H1627	DB1623A	8
15	1.750	.64	284	.33	410	.07	463	H1407	DB1401A	12
	2.125	.98	436	.55	678	.13	804	H1418	DB1411	10
	2.625	1.54	699	.92	1150	.22	1428	H1427	DB1421A	8
	3.000	2.04	966	1.03	1402	.22	1617	H1607	QB1260A	12
	3.500	2.94	1355	1.84	2364	.47	3120	H1438	DB1431A	6
18	5.000†	2.27	1308	1.38	2373	.41	4198	H1116	G1110†	3
20	1.333	.28	140	.15	210	.04	227	H1056	GB1050A	12
	1.625	.42	217	.25	336	.06	391	H1066	GB1060A	10
	2.000	.65	343	.41	567	.10	706	H1076	GB1070	8
	2.167	.83	483	.43	693	.09	794	H1407	DB1402A	12
	2.667	1.22	665	.80	1156	.22	1550	H1086	GB1077A	6
	2.625	1.25	742	.71	1156	.16	1374	H1418	DB1412	10
	3.250	1.98	1191	1.18	1974	.28	2433	H1427	DB1422	8
	4.000	2.92	1667	1.99	3025	.64	4663	H1106	GB1100	4
	4.333	3.77	2318	2.36	4034	.60	5420	H1438	DB1432A	6
24	3.000	1.42	933	.93	1613	.26	2163	H1086	GB1080A	6
	6.000†	3.23	2218	1.81	4020	.53	7109	H1116	G1111†	3
	4.500	3.41	2336	2.32	4235	.75	6504	H1106	GB1101	4
25	2.583	.99	726	.52	1048	.11	1197	H1407	DB1403A	12
	3.125	1.50	1112	.85	1730	.19	2048	H1418	DB1413A	10
	3.875	2.39	1794	1.43	2962	.34	3671	H1427	DB1423A	8
	5.167	2.27	1738	1.42	3028	.36	4018	H1438	D1433†	6
	30	1.750	.40	294	.21	410	.05	473	H1056	GB1051
2.125		.59	452	.35	693	.09	831	H1066	GB1061A	10
2.625		.90	725	.57	1197	.13	1286	H1076	GB1071	8
3.000		1.15	1008	.60	1450	.13	1663	H1407	DB1260A	12
3.500		1.69	1386	1.12	2426	.31	3233	H1086	GB1081A	6
3.625		1.74	1544	.98	2395	.22	2836	H1418	DB1414A	10
4.500		2.75	2489	1.65	4128	.39	5105	H1427	DB860A	8
7.000†		4.23	3326	2.53	6002	.76	10683	H1116	G1112†	3
32	5.500	2.13	1955	1.46	3546	.47	5445	H1106	G1102†	4
36	4.000	1.95	1915	1.29	3366	.36	4470	H1086	GB1082A	6
	8.000†	3.87	3990	1.33	4130	.68	12816	H1116	G1113†	3

*Torque in Lb. Ins.

†Cast Iron Gear Rating with Hardened Worm shown.

All Worm and Worm Gear Ratings are based on a Hardened Steel Worm used with a Bronze Worm Gear.

1. For a Hardened Steel Worm used with a Cast Iron Gear, multiply the listed Rating by .50.
2. For an Unhardened Steel Worm used with a Cast Iron Gear, multiply the listed Rating by .25.

Worms & Worm Gears

Steel-Hardened, Ground & Polished Worms Bronze Worm Gears

Approximate Horsepower and Torque* Ratings
For Class I Service (Service Factor = 1.0)

Ratio	Worm RPM		1800		600		100		Worm Cat. No.	Gear Cat. No.	DP
	Center Distance	Input HP	Output Torque	Input HP	Output Torque	Input HP	Output Torque				
40	2.167	.48	490	.26	672	.06	782	H1056	GB1052A	12	
	2.625	.72	742	.43	1134	.11	1361	H1066	GB1062A	10	
	3.250	1.12	1190	.71	1974	.18	2420	H1076	GB1072A	8	
	4.333	2.11	2310	1.39	4034	.38	5345	H1086	GB1078	6	
48	3.750	1.26	1614	.79	2622	.20	3267	H1076	GB1073	8	
	5.000	2.37	3110	1.56	5445	.43	7260	H1086	GB1083	6	
	10.000†	4.06	5320	1.68	6608	.72	17088	H1116	G1114†	3	
50	2.583	.55	700	.30	998	.07	1134	H1056	GB1053A	12	
	3.125	.83	1068	.51	1733	.12	1954	H1066	GB1063	10	
	3.875	1.30	1716	.82	2836	.21	3498	H1076	GB850	8	
	5.167	2.43	3327	1.60	5777	.44	7563	H1086	GB1079	6	
54	11.000†	4.34	5985	1.79	7434	.77	19224	H1116	G1115†	3	
	3.000	.60	924	.33	1323	.08	1664	H1056	GB1260A	12	
60	3.625	.91	1408	.54	2142	.13	2571	H1066	GB1064	10	
	4.500	1.42	2269	.89	3718	.23	4538	H1076	GB860	8	
	6.000	2.66	4370	1.75	7625	.49	10210	H1086	GB1087	6	
	7.000	2.79	5521	1.84	9605	.51	12705	H1086	GB1084	6	
80	3.833	.64	1288	.35	1849	.08	2118	H1056	GB1054	12	
	4.625	.96	1961	.57	3042	.14	3630	H1066	GB1067	10	
	5.750	1.49	3165	.94	5210	.24	6555	H1076	GB1074A	8	
100	4.667	.60	1505	.33	2206	.08	2458	H1056	GB1055	12	
	5.625	.90	2310	.54	3571	.13	4223	H1066	GB1065	10	
	7.000	1.40	3711	.88	6092	.22	7563	H1076	GB8100	8	

*Torque in Lb. Ins.

†Cast Iron Gear Rating with Hardened Worm shown.

All Worm and Worm Gear Ratings are based on a Hardened Steel Worm used with a Bronze Worm Gear.

1. For a Hardened Steel Worm used with a Cast Iron Gear, multiply the listed Rating by .50.
2. For an Unhardened Steel Worm used with a Cast Iron Gear, multiply the listed Rating by .25.
3. For an Unhardened Steel Worm used with a Bronze Gear, multiply the listed Rating by .35.

CENTER DISTANCES AND RATIOS AVAILABLE WITH STOCK WORM GEARING

Center Distance (inches)	Pitch	No. of Teeth in Gear	Worm Thread			Center Distance (inches)	Pitch	No. of Teeth in Gear	Worm Thread			Center Distance (inches)	Pitch	No. of Teeth in Gear	Worm Thread		
			Single	Double	Quad				Single	Double	Quad				Single	Double	Quad
.375	48	20	20	10	5	1.781	32	100	100	50	25	4.333	6	40	40	20	10
.479	48	30	30	15	7.5	1.875	16	50	50	25	12.5	4.500	8	60	60	30	15
.531	32	20	20	10	5	1.917	24	80	80	40	20	4.500	4	24	24	-	-
.583	48	40	40	20	10	2.000	8	20	20	10	5	4.625	10	80	80	40	20
.666	24	20	20	10	5	2.125	10	30	30	15	7.5	4.667	12	100	100	-	-
.688	48	50	50	25	12.5	2.167	12	40	40	20	10	5.000	6	48	48	-	-
.688	32	30	30	15	7.5	2.188	16	60	60	30	15	5.000	3	18	18	-	-
.792	48	60	60	30	15	2.250	24	96	96	48	24	5.167	6	50	50	25	12.5
.844	32	40	40	20	10	2.333	24	100	100	50	25	5.500	4	32	32	-	-
.875	24	30	30	15	7.5	2.583	12	50	50	25	12.5	5.625	10	100	100	50	-
.938	16	20	20	10	5	2.625	10	40	40	20	10	5.750	8	80	80	-	-
1.000	48	80	80	40	20	2.625	8	30	30	15	7.5	6.000	6	60	60	30	15
1.000	32	50	50	25	12.5	2.667	6	20	20	10	5	6.000	3	24	24	-	-
1.083	24	40	40	20	10	2.812	16	80	80	-	20	6.500	4	40	40	-	-
1.156	32	60	60	30	15	3.000	12	60	60	30	15	6.750	8	96	96	-	-
1.208	48	100	100	50	25	3.000	6	24	24	12	6	7.000	8	100	100	-	-
1.250	16	30	30	15	7.5	3.125	10	50	50	25	12.5	7.000	6	72	72	36	18
1.292	24	50	50	25	12.5	3.250	8	40	40	20	10	7.000	3	30	30	-	-
1.333	12	20	20	10	5	3.438	6	100	100	-	-	7.500	4	48	48	-	-
1.469	32	80	80	40	20	3.500	16	30	30	15	7.5	7.667	6	80	80	-	-
1.500	24	60	60	30	15	3.625	10	60	60	30	15	8.000	3	36	36	-	-
1.562	16	40	40	20	10	3.750	8	48	48	-	-	9.000	6	96	96	-	-
1.625	10	20	20	10	5	3.833	12	80	80	40	-	9.333	6	100	100	-	-
1.719	32	96	96	48	24	3.875	8	50	50	25	12.5	9.500	4	64	64	-	-
1.750	24	72	72	36	18	4.000	6	36	36	-	-	10.000	3	48	48	-	-
1.750	12	30	30	15	7.5	4.000	4	20	20	-	-	11.000	3	54	54	-	-

Example: Given a center distance of 2.625", Table lists Worm and Worm Gear Ratios available:
 10 Pitch, 40 tooth, single = 40 to 1
 10 Pitch, 40 tooth, double = 20 to 1
 10 Pitch, 40 tooth, quad = 10 to 1
 8 Pitch, 30 tooth, single = 30 to 1
 8 Pitch, 30 tooth, double = 15 to 1
 8 Pitch, 30 tooth, quad = 7.5 to 1



SECTION CONTENTS

SHAFT COUPLINGS

Catalog Number Selections/Dimensions 100-106
 Engineering 320

UNIVERSAL JOINTS

General Description..... 107
 Catalog Number Selections/Dimensions 108-113
 Engineering 320

SHAFT COLLARS

Set Screw Collars 114
 Clamping Collars 115-117

THRUST WASHERS

Catalog Number Selections/Dimensions 118

BUSHINGS

Catalog Number Selections/Dimensions 119

PULLEYS (ROUND)

Catalog Number Selections/Dimensions 120

MINIATURE TIMING BELTS AND PULLEYS

General Description/Engineering 121
 Timing Belt Selections/Dimensions 124, 130
 Timing Belt Pulleys Selections/Dimensions 125-129
 131-134



Shaft Couplings

FC and SSFC Series

Insert (3-Jaw) Type



AVAILABLE IN STEEL AND IN 316 STAINLESS STEEL

PRECISION MACHINED BORED OR SOLID HUBS

THREE TYPES OF INSERTS for different service requirements

NO LUBRICATION NEEDED

COMPLETE WITH KEYWAY AND SETSCREW

CUSTOM BORE SIZES AVAILABLE ON REQUEST

Reference Pages

Alignment—320

Keyways and Setscrews—321

Coupling Inserts

OIL-IMPREGNATED BOST-BRONZ— Recommended for high torque loads, particularly at slower speeds.

OIL-RESISTANT SYNTHETIC RUBBER— Recommended where quietness is desired, particularly at motor speeds.

POLYURETHANE— Recommended where moderate to heavy shock loads are encountered.

Load Data

**HORSEPOWER AND TORQUE RATING AT
RECOMMENDED SPEEDS FOR INSERTS INDICATED**

Coupling Size	Shaft Diameter Range	Maximum Horsepower Rating At RPM Of *								Max Torque (Lb. Ins.)
		50	100	300	690	870	1150	1750	3450	
XFCBB BOST-BRONZ INSERTS										
FC12 & SSFC12	3/8-5/8	.16	.32	.95	2.2	2.8	3.6	5.6	—	200
FC15 & SSFC15	1/2-7/8	.40	.79	2.4	5.5	6.9	9.1	13.9	—	500
FC20 & SSFC20	1/2-1-1/8	.79	1.6	4.8	10.9	13.8	18.2	—	—	1000
FC25 & SSFC25	3/4-1-3/8	1.4	2.9	8.6	19.7	24.8	—	—	—	1800
FC30 & SSFC30	1-1-5/8	2.5	5.1	15.2	35.0	—	—	—	—	3200
FC38 & SSFC38	1-1/4-1-7/8	5.6	11.1	33.3	—	—	—	—	—	7000
FC45 & SSFC45	1-3/4-2-1/8	8.7	17.5	—	—	—	—	—	—	11000
XFCR RUBBER INSERTS										
FC12 & SSFC12	3/8-5/8	—	.10	.31	.71	.90	1.2	1.8	3.6	65
FC15 & SSFC15	1/2-7/8	—	.20	.60	1.4	1.7	2.3	3.5	56.8	125
FC20 & SSFC20	1/2-1-1/8	—	.40	1.2	2.7	3.5	4.6	6.9	13.7	250
FC25 & SSFC25	3/4-1-3/8	—	.71	2.1	4.9	6.2	8.2	12.5	24.6	450
FC30 & SSFC30	1-1-5/8	—	1.3	3.8	8.8	11.0	14.6	22.2	43.8	800
FC38 & SSFC38	1-1/4-1-7/8	—	2.5	7.6	17.5	22.1	29.2	44.4	—	1600
FC45 & SSFC45	1-3/4-2-1/8	—	4.4	13.3	30.7	38.7	51.1	77.7	—	2800
XFCA POLYURETHANE INSERTS										
FC12 & SSFC12	3/8-5/8	.09	.19	.56	1.2	1.6	2.0	3.0	5.7	125
FC15 & SSFC15	1/2-7/8	.18	.37	1.1	2.5	3.1	4.0	6.0	11.3	250
FC20 & SSFC20	1/2-1-1/8	.35	.70	2.1	4.6	5.7	7.5	11.1	20.7	470
FC25 & SSFC25	3/4-1-3/8	.62	1.2	3.7	8.1	10.1	13.1	19.3	35.8	845
FC30 & SSFC30	1-1-5/8	1.1	2.2	6.5	14.4	17.9	23.3	34.3	63.6	1500
FC38 & SSFC38	1-1/4-1-7/8	2.2	4.3	12.9	28.4	35.3	45.8	67.3	—	3000
FC45 & SSFC45	1-3/4-2-1/8	3.7	7.5	22.4	49.2	61.0	79.0	115.9	—	5250

*For uniform load.

Selection Procedure

- From Table select Service Factor.
- Determine Design Load
Design HP = Application HP x S.F.
or
Design Torque = Application Torque x S.F.
- Select coupling size from Load Rating Table which has a rating equal to or greater than the design load.

COUPLING SERVICE FACTORS

Load Classification	Service Factor
Uniform	1.0
Moderate Shock	1.75
Heavy Shock	2.50



Contact the factory for bore sizes not listed above. Inch and metric options available.

Shaft Couplings

FC and SSFC Series Stocked Bores or Solid Hubs Insert (3-Jaw) Type

STANDARD TOLERANCES

DIMENSIONS		TOLERANCE
Bore	All	+ .001 - .000

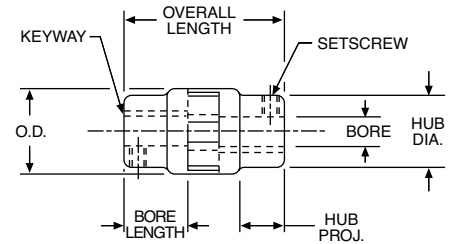

ALL DIMENSIONS IN INCHES

ORDER BY CATALOG NUMBER OR ITEM CODE

To order complete coupling order two coupling halves and one coupling insert

Coupling Size	Bore	Coupling Halves				Dimensions							Insert					
		Steel		Stainless Steel		Max. Bore	Bore Length*	OD	Overall Length**	Hub		Assy. Clearance	Bost-Bronz		Rubber		Polyurethane	
		Catalog Number	Item Code	Catalog Number	Item Code					Dia.	Proj.		Catalog Number	Item Code	Catalog Number	Item Code	Catalog Number	Item Code
FC12 and SSFC12	SOLID	FC12 SOLID	47448	SSFC12 SOLID	G89785	5/8	N/A	1-1/4	2-5/16	1	5/8	3-3/16	XFCBB12	08064	XFCR12	08078	XFCA12	08050
	3/8	FC12-3/8	08246	SSFC12-3/8	G89783		27/32											
	7/16	FC12-7/16	08248	N/A	N/A													
	1/2	FC12-1/2	08250	SSFC12-1/2	G89784													
	5/8	FC12-5/8	52405	N/A	N/A													
FC15 and SSFC15	SOLID	FC15 SOLID	47449	SSFC15 SOLID	G89789	7/8	N/A	1-1/2	2-3/4	1-1/4	3/4	3-3/4	XFCBB15	08066	XFCR15	08080	XFCA15	08052
	1/2	FC15-1/2	08252	SSFC15-1/2	G89786		1-1/32											
	9/16	FC15-9/16	61421	N/A	N/A													
	5/8	FC15-5/8	08254	SSFC15-5/8	G89787													
	3/4	FC15-3/4	08256	SSFC15-3/4	G89788													
FC20 and SSFC20	SOLID	FC20 SOLID	47450	SSFC20 SOLID	G89794	1-1/8	N/A	2	3-11/16	1-3/4	1-1/8	4-13/16	XFCBB20	08068	XFCR20	08082	XFCA20	08054
	1/2	FC20-1/2	08258	N/A	N/A		1-7/16											
	9/16	FC20-9/16	66063	N/A	N/A													
	5/8	FC20-5/8	08260	SSFC20-5/8	G89790													
	3/4	FC20-3/4	08262	SSFC20-3/4	G89791													
	7/8	FC20-7/8	08264	SSFC20-7/8	G89792													
	15/16	FC20-15/16	08266	N/A	N/A													
	1	FC20-1	08268	SSFC20-1	G89793													
FC25 and SSFC25	SOLID	FC25 SOLID	47451	SSFC25 SOLID	G89798	1-3/8	N/A	2-1/2	4-1/8	2-1/4	1-1/4	5-3/8	XFCBB25	08070	XFCR25	08084	XFCA25	08056
	3/4	FC25-3/4	08270	SSFC25-3/4	G89795		1-19/32											
	7/8	FC25-7/8	08272	N/A	N/A													
	1	FC25-1	08274	SSFC25-1	G89796													
	1-1/8	FC25-1-1/8	08276	N/A	N/A													
	1-3/16	FC25-1-3/16	08278	N/A	N/A													
	1-1/4	FC25-1-1/4	08280	SSFC25-1-1/4	G89797													
	1-3/8	FC25-1-3/8	52408	N/A	N/A													
FC30 and SSFC30	SOLID	FC30 SOLID	47452	SSFC30 SOLID	G89802	1-5/8	N/A	3	5-15/32	2-3/4	1-11/16	7	XFCBB30	08072	XFCR30	08086	XFCA30	08058
	1	FC30-1	08282	SSFC30-1	G89799		2-5/32											
	1-1/8	FC30-1-1/8	08284	N/A	N/A													
	1-1/4	FC30-1-1/4	08286	SSFC30-1-1/4	G89800													
	1-3/8	FC30-1-3/8	08288	SSFC30-1-3/8	G89801													
	1-7/16	FC30-1-7/16	08290	N/A	N/A													
	1-1/2	FC30-1-1/2	08292	N/A	N/A													
	1-5/8	FC30-1-5/8	52409	N/A	N/A													
FC38 and SSFC38	SOLID	FC38 SOLID	24650	SSFC38 SOLID	G89809	1-7/8	N/A	3-3/4	6-5/16	3-1/2	1-7/8	8-3/16	XFCBB38	08074	XFCR38	08088	XFCA38	08060
	1-1/4	FC38-1-1/4	08294	N/A	N/A		2-5/8											
	1-1/2	FC38-1-1/2	08296	N/A	N/A													
	1-9/16	FC38-1-9/16	08298	N/A	N/A													
	1-5/8	FC38-1-5/8	08300	N/A	N/A													
	1-3/4	FC38-1-3/4	08302	N/A	N/A													
FC45 and SSFC45	SOLID	FC45 SOLID	24816	SSFC45 SOLID	G89810	2-1/8	N/A	4-1/2	7-3/16	4	2-1/8	9-5/16	XFCBB45	08076	XFCR45	08090	XFCA45	08062
	1-3/4	FC45-1-3/4	08306	N/A	N/A		3											
	1-7/8	FC45-1-7/8	08308	N/A	N/A													
	2	FC45-2	08310	N/A	N/A													
2-1/8	FC45-2-1/8	08312	N/A	N/A														

*Length of hole in each half. **Total Length of assembled coupling with jaws engaged to full depth.

Notes: Bore tolerance +.001"/-.000"

Recommended shaft tolerance: Nominal +.000"/-.001"

Shaft Couplings

BF Series Bost-Flex® Spider Ring (3-Jaw) Type



ECONOMICAL 3-JAW COUPLING

SPIDER RING URETHANE INSERT absorbs shock and vibration. Provides through opening for close coupling of shafts.

BORE SIZES FROM 3/8" TO 1-1/4"

COMPLETE WITH KEYWAY AND SETSCREW.

STANDARD TOLERANCES

DIMENSIONS		TOLERANCE
Bore	All	+ .001 - .000

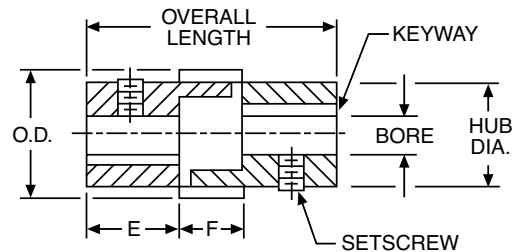

Reference Pages

Alignment—320

Keyways and Setscrews—321

ALL DIMENSIONS IN INCHES
ORDER BY CATALOG NUMBER OR ITEM CODE
Includes two coupling halves and one coupling insert

Coupling Size	Bore		Hub Diameter	O.D.	Overall Length	E	F	Assembly Clearance	Approx. Weight (Oz.)	Coupling		Replacement Insert
	A	B								Catalog Number	Item Code	Item Code
BF7	3/8	3/8	7/8	1-7/32	1-5/16	1/2	5/16	1-5/8	2	BF7 3/8-3/8	11730	11722
		1/2								BF7 3/8-1/2	11734	
	1/2	1/2								BF7 1/2-1/2	11732	
BF10	1/2	1/2	1-1/4	1-19/32	1-15/16	3/4	7/16	2-3/8	6.5	BF10 1/2-1/2	11736	11724
		5/8								BF10 1/2-5/8	11742	
		3/4								BF10 1/2-3/4	11744	
	5/8	5/8								BF10 5/8-5/8	11738	
		3/4								BF10 5/8-3/4	11746	
BF13	3/4	3/4	1-5/8	1-31/32	2-7/16	15/16	9/16	3	14	BF10 3/4-3/4	11740	11726
		7/8								BF13 3/4-3/4	11748	
		1								BF13 3/4-7/8	11754	
	7/8	7/8								BF13 3/4-1	11756	
		1								BF13 7/8-7/8	11750	
		1								BF13 7/8-1	11758	
BF18	1	1	2-1/4	2-23/32	2-15/16	1-1/8	11/16	3-5/8	37	BF13 1-1	11752	11728
		1-1/8								BF18 1-1	11760	
		1-1/4								BF18 1-1-1/8	11766	
	1-1/8	1-1/8								BF18 1-1-1/4	11768	
		1-1/4								BF18 1-1/8-1-18	11762	
		1-1/4								BF18 1-1/8-1-1/4	11770	
	1-1/4	BF18 1-1/4-1-1/4	11764									

HORSEPOWER AND TORQUE RATINGS

Size	Revolutions per Minute							Max Torque (Lb. Ins.)
	100	300	690	870	1150	1750	3450	
BF 7	.044	.13	.31	.39	.51	.78	1.5	28
BF 10	.11	.34	.78	1.00	1.30	2.00	3.9	72
BF13	.25	.76	1.70	2.20	2.90	4.40	8.8	160
BF 18	.48	1.40	3.30	4.10	5.50	8.30	16.4	300

Selection Procedure

For Service Factors and Procedures, refer to FC Couplings (Page 100).

Shaft Couplings

BG Series Shear Type

ALL DIMENSIONS IN INCHES
ORDER BY CATALOG NUMBER OR ITEM CODE

Coupling Size	Bore		Hub Diameter	O.D.	Overall Length	F	Catalog Number	Item Code
	A	B						
BG47	1/8	1/8	7/16	9/16	13/16	3/16	BG47-2-2	49887
		3/16					BG47-2-3	49888
	3/16	1/4					BG47-2-4	49889
		3/16					BG47-3-3	49890
1/4	1/4	BG47-3-4	49891					
		BG47-4-4	49892					
BG11-1	1/4	1/4	5/8	13/16	1-3/8	11/32	BG11-1-4-4	49895
BG11-2	1/4	1/4	3/4	1	1-3/4	13/32	BG11-2-4-4	49898
		5/16					BG11-2-4-5	49899
	5/16	3/8					BG11-2-4-6	49900
		3/8					BG11-2-5-5	49901
3/8	3/8	BG11-2-5-6	49902					
		BG11-2-6-6	49903					
		BG11-3-5-5	49904					
BG11-3	5/16	3/8	7/8	1-1/4	2-1/8	15/32	BG11-3-5-6	49905
		1/2					BG11-3-5-8	49906
	3/8	3/8					BG11-3-6-6	49907
		1/2					BG11-3-6-8	49908
BG11-4	3/8	3/8	1	1-3/8	2-1/4	17/32	BG11-4-6-6	49910
		5/8					BG11-4-6-8	49911
		5/8					BG11-4-6-10	49912
	1/2	1/2					BG11-4-8-8	49913
		5/8					BG11-4-8-10	49914
5/8	5/8	BG11-4-10-10	49915					
BG11-5	1/2	1/2	1-1/8	1-5/8	2-1/2	19/32	BG11-5-8-8	49916
		5/8					BG11-5-8-10	49917
	3/4	3/4					BG11-5-8-12	49918
		3/4					BG11-5-10-10	49919
BG11-6	1/2	1/2	1-3/8	1-13/16	2-11/16	11/16	BG11-6-8-8	49921
		5/8					BG11-6-10-10	49923
	3/4	3/4					BG11-6-10-12	49924
		3/4					BG11-6-12-12	49925
BG11-7	1	1	1-1/2	2	2-7/8	3/4	BG11-7-16-16	49931

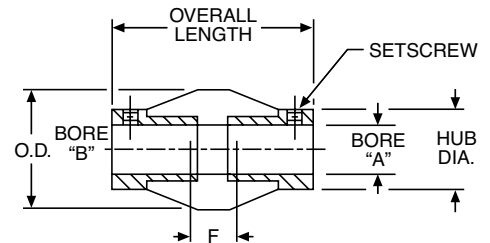

METAL HUBS JOINED PERMANENTLY BONDED ELASTOMER require no lubrication. Flexible in any direction—accommodates misalignment up to 1/32" parallel, 2" angular.

HIGH TORSIONAL DEFLECTION isolates low frequency vibration.

BORE SIZES FROM 1/8" TO 1"

COMPLETE WITH STANDARD SETSCREWS (Not installed).

Load Data

HORSEPOWER AND TORQUE RATINGS

Size	Revolutions per Minute							Max Torque (Lb. Ins.)
	100	300	690	870	1150	1750	3450	
BG-47	.001	.003	.008	.010	.013	.020	.039	.72
BG11-1	.004	.011	.025	.031	.041	.062	.123	2.25
BG11-2	.007	.021	.049	.062	.082	.125	.246	4.50
BG11-3	.014	.043	.099	.124	.164	.250	.493	9.00
BG11-4	.019	.057	.131	.166	.219	.333	.657	12.00
BG11-5	.029	.086	.197	.248	.328	.500	.985	18.00
BG11-6	.043	.129	.296	.313	.493	.750	1.478	27.00
BG11-7	.057	.171	.394	.497	.657	1.000	1.971	36.00

STANDARD TOLERANCES

DIMENSIONS		TOLERANCE
Bore	1/8 - 3/8	+ .001 - .000
	1/2 - 5/8	+ .0015 - .000
	3/4 - 1	+ .002 - .000

Reference Pages

Alignment—320

Keyways and Setscrews—321

E

Shaft Couplings

SCC Series

Clamping Type

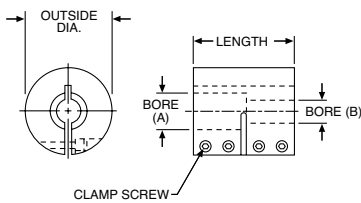

STANDARD TOLERANCES

DIMENSIONS		TOLERANCE
Bore	All	+.001 - .000

LOW CARBON STEEL COUPLINGS with a black oxide finish.

BORE SIZES FROM 1/4" to 2"

ALL DIMENSIONS IN INCHES
ORDER BY CATALOG NUMBER OR ITEM CODE

Bore		O.D.	Length	Clamp Screws (4)	Catalog Number	Item Code
A	B					
1/4	1/4	13/16	1-1/4	4-40	SCC1/4 x 1/4	49289
3/8	1/4	1-1/16	1-5/8	6-32	SCC3/8 x 1/4	49290
	3/8				SCC3/8 x 3/8	49291
1/2	3/8	1-1/4	1-7/8	8-32	SCC1/2 x 3/8	49292
	1/2				SCC1/2 x 1/2	49293
5/8	1/2	1-1/2	2-1/4	10-32	SCC5/8 x 1/2	49294
	5/8				SCC5/8 x 5/8	49295
3/4	1/2	1-3/4	2-5/8	1/4-28	SCC3/4 x 1/2	49296
	5/8				SCC3/4 x 5/8	49297
	3/4				SCC3/4 x 3/4	49298
7/8	5/8	1-7/8	2-7/8	1/4-28	SCC7/8 x 5/8	49299
	7/8				SCC7/8 x 7/8	49300
1	1	2	3	1/4-28	SCC1 x 1	49302
1-1/8	1	2-1/8	3-1/4	1/4-28	SCC1-1/8 x 1	49303
	1-1/8				SCC1-1/8 x 1-1/8	49304
1-1/4	1	2-1/4	3-3/8	1/4-28	SCC1-1/4 x 1	49305
	1-1/4				SCC1-1/4 x 1-1/4	49306
1-3/8	1	2-3/8	3-5/8	1/4-28	SCC1-3/8 x 1	49307
	1-3/8				SCC1-3/8 x 1-3/8	49308
1-1/2	1	2-1/2	3-3/4	1/4-28	SCC1-1/2 x 1	49309
	1-1/2				SCC1-1/2 x 1-1/2	49310
1-3/4	1-3/4	3	4-1/2	5/16-24	SCC1-3/4 x 1-3/4	49312
	2				2	3-1/4

Load Data

Capacity is based on a standard steel, one piece coupling mounted with recommended screw torque on a dry shaft. Capacities shown are for general guidance only. In applications involving control of torque loads, capacity should be determined experimentally on actual parts involved.

TORQUE CAPACITY

Bore	Torque Capacity (Lb. Ins.)	Screw Size	Recommended Screw Torque (Lb. Ins.)
1/4	72	4-40	20
3/8	192	6-32	30
1/2	480	8-32	55
5/8	1200	10-32	90
3/4	1500	1/4-28	220
7/8	1680		
1	1920		
1-1/8	2200		
1-1/4	3000		
1-3/8	3500		
1-1/2	4000	5/16-24	435
1-3/4	5400		
2	6000		

E

Shaft Couplings

FA Series Multi-Jaw Type

UNTREATED STEEL COUPLINGS for use in light duty applications, require no lubrication.

BORE SIZES FROM 3/16" to 1/2"

COMPLETE WITH STANDARD SETSCREWS

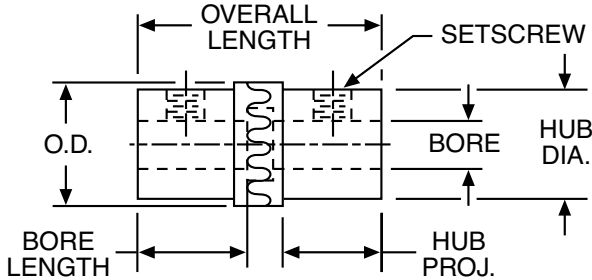
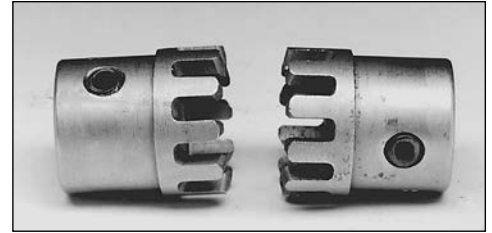

STANDARD TOLERANCES

DIMENSIONS		TOLERANCE
Bore	All	± .0005

Reference Pages

Alignment—320
Keyways and Setscrews—321

ALL DIMENSIONS IN INCHES
ORDER BY CATALOG NUMBER OR ITEM CODE

Coupling Size	Bore	O.D.	Length†	Bore Length++	Assembly Clearance‡	Hub		Teeth	Steel	
						Dia.	Proj.		Catalog Number	Item Code
FA5	3/16	1/2	1-1/8	1/2	1-9/32	7/16	7/16	10	FA5 3/16-3/16	07900
	7/32								FA5 7/32-7/32	07902
	1/4								FA5 1/4-1/4	07904
FA75	5/16	3/4	1-1/2	5/8	1-3/4	11/16	33/64	10	FA75 5/16-5/16	07910
	3/8								FA75 3/8-3/8	07912
FA10	7/16	1	2	7/8	2-9/32	15/16	3/4	12	FA10 7/16-7/16	07908
	1/2								FA10 1/2-1/2	07906

†Total length of coupling with jaws engaged full depth. ++Length of hole in each half.
‡Approximate total length of coupling with jaws completely disengaged.

CR Series Rigid (One Piece) Type

BORE SIZES FROM 1/4" TO 1-1/4"

COMPLETE WITH STANDARD SETSCREWS

ALL DIMENSIONS IN INCHES
ORDER BY CATALOG NUMBER OR ITEM CODE

Bore	O.D.	Overall Length	A	Catalog Number	Item Code
1/4	1/2	3/4	3/16	CR4	34200
5/16	5/8	1	1/4	CR5	34202
3/8	3/4	1	1/4	CR6	34204
1/2	1	1-1/2	3/8	CR8	34206
5/8	1-1/4	2	1/2	CR10	34208
3/4	1-1/2	2	1/2	CR12	34210
7/8	1-3/4	2	1/2	CR14	34212
1	2	3	3/4	CR16	34214
1-1/4	2-1/4	4	1	CR20	34216

STANDARD TOLERANCES

DIMENSIONS		TOLERANCE
Bore	All	+ .001 - .000

Reference Pages

Keyways and Setscrews—320

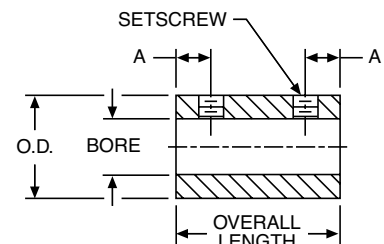

Shaft Couplings

FCP Series

Sleeve Type



SPLINED HUBS AND URETHANE SLEEVE accommodate misalignment to 5°.

SLEEVE STOCK available for producing special lengths.

NO LUBRICATION NEEDED

COMPLETE WITH SETSCREWS

Materials

Urethane Sleeves
Delrin Hubs
Aluminum Alloy Inserts

STANDARD TOLERANCES

DIMENSIONS	TOLERANCE
Bore	All
	+ .001 - .000

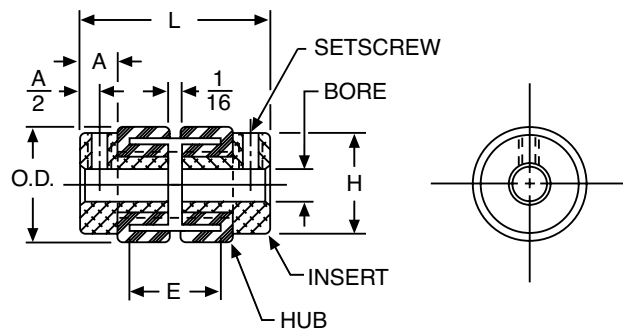

ALL DIMENSIONS IN INCHES ORDER BY CATALOG NUMBER OR ITEM CODE

Bore	O.D.	A	E	H	L	Setscrew	Complete Coupling		Insert and Hub Assembly		Sleeve Only	
							Catalog Number	Item Code	Catalog Number	Item Code	Catalog Number	Item Code
.125	37/64	7/32	7/16	9/16	15/16	4 - 40	FCP21 - 1/8	54893	XFCP21 - 1/8	54903	X5R21 - 16	54913
.1875						6 - 32	FCP21 - 3/16	54894	XFCP21 - 3/16	54904		
.250							FCP21 - 1/4	54895	XFCP21 - 1/4	54905		
.3125	1-5/64	3/8	11/16	1	1-9/16	8 - 32	FCP23 - 5/16	54899	XFCP23 - 5/16	54909	X5R23 - 32	54915
.375						10 - 32	FCP23 - 3/8	54900	XFCP23 - 3/8	54910		
.4375							FCP23 - 7/16	54901	XFCP23 - 7/16	54911		
.500						1/4 - 20	FCP23 - 1/2	54902	XFCP23 - 1/2	54912		

Load Data

HORSEPOWER RATINGS (MAXIMUM) AT 1750 RPM

Size	Horsepower
FCP21	1/20
FCP23	1/2

Sleeve Stock

ORDER BY CATALOG NUMBER OR ITEM CODE

O.D.	Length (Inches)	Catalog Number	Item Code
1/2	12	5R21 - 16S	54916
1		5R23 - 32S	54918

E

J/JS Series

Pin and Block Type; Steel and Stainless Steel

Boston Gear precision machined J and JS Series Universal Joints are designed for connecting shafts at angles up to 30 degrees and speeds up to 2000 RPM. All sizes are stocked with both solid and bored hubs.

Joints J100 and J100B and larger are equipped with self-closing, ball valve oilers, creating an oil reservoir to provide enclosed lubrication.

The self-locking assembly ring on joints with 7/8" and larger hub diameter, fits into recess provided in center bearing block and snaps around groove in small bearing pin — assuring locking of entire assembly allowing for quick and easy disassembly and reassembly.

Joints with 3/4" and smaller hub diameters are locked by riveting the small bearing pin. Joint covers (boots) keep dirt and moisture out and lubricants in.



Selection

Torque ratings may be calculated from data in tables. The tables indicate the Rated Static Torque (Lb. Ins.) of alloy and stainless steel joints and Speed-Angle factors suggested for various operating conditions.

The approximate service torque rating of a particular joint is obtained by dividing the Rated Static Torque by the appropriate Speed-Angle factor.

Selecting a universal to satisfy a specified torque requirement is also made convenient with the data provided.

The designated torque load should be multiplied by the appropriate Speed-Angle factor to obtain an equivalent static torque load.

A universal with a rated static torque equal to or greater than the calculated torque load would then be selected.

Example:

A pair of universal joints are desired to transmit 1/2 HP from one shaft running at 500 RPM to another located at an angle of 10 degrees (from a straight line).

The joints will be connected by an intermediate shaft and arranged to operate at equal angles of 5 degrees.

A Speed-Angle factor of 9 is indicated in the table for an operating angle of 5 degrees and a speed of 500 RPM.

$$\text{Torque Load} = \frac{63025 \times \text{HP}}{\text{RPM}} = \frac{63025 \times 1/2}{500} = 63 \text{ Lb. Ins.}$$

J100 size alloy steel or JS175 size stainless steel universals would be suggested for this application.

SPEED-ANGLE FACTORS

Speed In RPM	Operating Angle – Degrees (Deviation From Straight Line)														
	0	1/2	1	2	3	4	5	6	8	10	12	15	20	25	30
2000	21	22	23.2	25.2	27.4	29.4	31.6	-	-	-	-	-	-	-	-
1800	19	20	21.0	22.8	24.8	26.6	28.6	30.4	-	-	-	-	-	-	-
1600	17	17.8	18.8	20.4	22.2	23.8	25.6	27.2	-	-	-	-	-	-	-
1400	15	15.8	16.6	18.0	19.6	21.0	22.6	24.0	27	-	-	-	-	-	-
1200	13	13.6	14.4	15.6	17.0	18.2	19.6	20.8	23.4	-	-	-	-	-	-
1000	11	11.6	12.2	13.2	14.4	15.4	16.6	17.6	19.8	22	-	-	-	-	-
900	10	10.6	11.0	12.0	13.0	14.0	15.0	16.0	18.0	20	22	-	-	-	-
800	9.0	9.4	10.0	10.8	11.8	12.6	13.6	14.4	16.2	18	19.8	-	-	-	-
700	8.0	8.4	8.8	9.6	10.4	11.2	12.0	12.8	14.4	16	17.6	20	-	-	-
600	7.0	7.4	7.8	8.4	9.2	9.8	10.6	11.2	12.6	14	15.4	17.6	-	-	-
500	6.0	6.4	6.6	7.2	7.8	8.4	9.0	9.6	10.8	12	13.2	15.0	18	-	-
400	5.0	5.2	5.6	6.0	6.6	7.0	7.6	8.0	9.0	10	11.0	12.6	15	17.6	-
300	4.0	4.2	4.4	4.8	5.2	5.6	6.0	6.4	7.2	8.0	8.8	10.0	12	14.0	16
200	3.0	3.2	3.4	3.6	4.0	4.2	4.6	4.8	5.4	6.0	6.6	7.6	9.0	10.6	12
100	2.0	2.2	2.2	2.4	2.6	2.8	3.0	3.2	3.6	4.0	4.4	5.0	6.0	7.0	8.0
50	1.5	1.6	1.7	1.8	2.0	2.2	2.2	2.4	2.8	3.0	3.4	3.8	4.6	5.2	6.0
25	1.3	1.3	1.4	1.5	1.6	1.8	1.9	2.0	2.2	2.6	2.8	3.2	3.8	4.4	5.0
10	1.1	1.2	1.2	1.3	1.4	1.5	1.7	1.8	2.0	2.2	2.4	2.8	3.4	3.8	4.4
0	1.0	1.1	1.1	1.2	1.3	1.4	1.5	1.6	1.8	2.0	2.2	2.6	3.0	3.6	4.0

RATED STATIC TORQUE (LB. INS.)

STRAIGHT LINE

ALLOY STEEL UNIVERSAL JOINTS

Catalog Number	J37	J50	J62	J75	J87	J100	J112	J125	J150	J175	J200	J250	J300	J400
Torque – Lb. Ins.	20	80	166	320	370	600	670	1040	1680	2500	4400	7000	11,000	26,400

STAINLESS STEEL UNIVERSAL JOINTS

Catalog Number	JS37	JS50	JS62	JS75	JS87	JS100	JS112	JS125	JS150	JS175	JS200	JS250	JS300	JS400
Torque – Lb. Ins.	6	24	50	96	110	180	200	310	500	750	1320	1900	3100	7360

Universal Joints

J/JS Series Bored and Solid Hubs Pin and Block Type; Steel and Stainless Steel

STANDARD TOLERANCES

DIMENSIONS		TOLERANCE	
		Steel	Stainless
Bore	All	± .001	±.001
Hub Dia.	All	+ .000 - .003	±.020
Bore Length	All	±1/16	±1/64
Overall Length	1-3/4 - 4-1/4	±1/64	±1/64
Length	5 -10-5/8	±1/32	±1/32

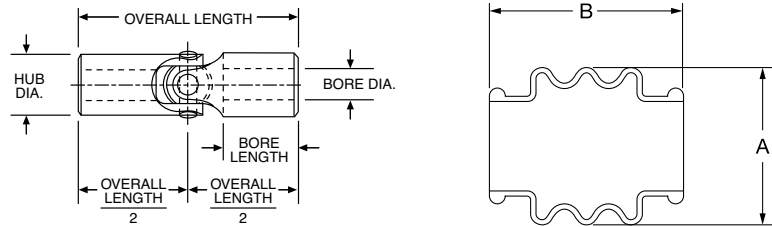

Reference Pages

Lubrication—320
Mounting—320

ALL DIMENSIONS IN INCHES ORDER BY CATALOG NUMBER OR ITEM CODE

Steel		Stainless Steel		Universal Joints								Boot Kits† ††			
Catalog Number	Item Code	Catalog Number	Item Code	Bore**	Bore Length*	Hub Dia.	Overall Length	Keyway	Setscrew	Approx. Weight Lbs.	A	B	Catalog Number	Item Code	
J37B	08426	JS37B	08472	3/16	11/16	3/8	1-3/4	-	-	.04	0.72	0.88	UB37	47602	
J37	08400	JS37	08452	-	-	3/8	1-3/4	-	-	.05					
J50B	08428	JS50B	08474	1/4	3/4	1/2	2	-	-	.08	0.95	0.88	UB50	47603	
J50	08402	JS50	08454	-	-	1/2	2	-	-	.10					
J62B	08430	JS62B	08476	5/16	13/16	5/8	2-1/4	-	-	.14	1.13	1.03	UB62	47604	
J62	08404	JS62	08456	-	-	5/8	2-1/4	-	-	.18					
J75B	08432	JS75B	08478	3/8	31/32	3/4	2-11/16	-	-	.24	1.38	1.25	UB75	47605	
J75	08406	JS75	08458	-	-	3/4	2-11/16	-	-	.30					
J87B	08434	JS87B	08480	7/16	1-1/32	7/8	3	-	-	.31	1.50	1.38	UB87	47606	
J87	08408	JS87	08460	-	-	7/8	3	-	-	.45					
J100A-1/2	72472	-	-	1/2	1-3/16	1	3-3/8	1/8x1/16	1/4-20NC	.50					
J100B	08436	JS100B	08482	1/2	1-3/16	1	3-3/8	-	-	.50	1.50	1.50	UB100	47607	
J100	08410	JS100	08462	-	-	1	3-3/8	-	-	.66					
J112B	72474	JS112B	72483	9/16	1-7/32	1-1/8	3-1/2	-	-	.69	1.75	1.63	UB112	72491	
J112	72475	JS112	72484	-	-	1-1/8	3-1/2	-	-	.88					
J125A-5/8	72476	-	-	5/8	1-1/4	1-1/4	3-3/4	3/16x3/32	5/16-18NC	.88					
J125B	08438	JS125B	08484	5/8	1-1/4	1-1/4	3-3/4	-	-	.88	1.88	2.09	UB125	47608	
J125	08412	JS125	08464	-	-	1-1/4	3-3/4	-	-	1.15					
J150A-3/4	72477	-	-	3/4	1-11/32	1-1/2	4-1/4	3/16x3/32	5/16-18NC	1.44					
J150B	08440	JS150B	08486	3/4	1-11/32	1-1/2	4-1/4	-	-	1.44	2.25	2.06	UB150	47609	
J150	08414	JS150	08466	-	-	1-1/2	4-1/4	-	-	1.81					
J175A-7/8	72478	-	-	7/8	1-9/16	1-3/4	5	3/16x3/32	5/16-18NC	2.31					
J175B	08442	JS175B	08488	7/8	1-9/16	1-3/4	5	-	-	2.31	2.69	2.63	UB175	47610	
J175	08416	JS175	08468	-	-	1-3/4	5	-	-	2.86					
J200A-1	72479	-	-	1	1-5/8	2	5-1/2	1/4x1/8	3/8-16NC	3.31					
J200B	08444	JS200B	08490	1	1-5/8	2	5-1/2	-	-	3.31	2.69	3.00	UB200	47611	
J200	08418	JS200	08470	-	-	2	5-1/2	-	-	4.06					
J250A-1-1/4	72480	-	-	1-1/4	2-3/32	2-1/2	7	1/4x1/8	3/8-16NC	6.81					
J250B	08446	JS250B	72485	1-1/4	2-3/32	2-1/2	7	-	-	6.81	3.50	4.00	UB250	47612	
J250	08420	JS250	72486	-	-	2-1/2	7	-	-	8.25					
J300B	08448	JS300B	72487	1-1/2	2-27/32	3	9	-	-	12.5	4.25	4.63	UB300	47613	
J300	08422	JS300	72488	-	-	3	9	-	-	15.25					
J400B	08450	JS400B	72489	2	3-1/8	4	10-5/8	-	-	25.8	6.00	5.50	UB400	47614	
J400	08424	JS400	72490	-	-	4	10-5/8	-	-	31.3					

*Approximate Hub Projection

†Each Kit contains (2) Boots and (4) Ties together with complete instructions for installation and lubrication.

**Style A includes bore, keyway and setscrew. Style B includes bore only. Units without an A & B letter have a solid bore.

†† Assemble the boot to be positioned central to the joint.

The shape of the boot may vary from the image shown above.

UJAS/UJNL Series BOS-Trong®

Cast Steel

A BOS-trong joint is composed of two yokes and a center kit. BOS-trong joints may be purchased assembled, or as separate yokes and center kits. Individually boxed.

AVAILABLE IN TWO SIZES

EQUIPPED WITH NEEDLE BEARINGS

PRECISION MACHINED FOR LONG, SMOOTH OPERATION

CONTINUOUS OR INTERMITTENT SERVICE

HIGH CAPACITY WITH MINIMUM SWING DIAMETERS

AVAILABLE WITH ROUND, SQUARE OR HEXAGON HOLES

COMPLETE WITH KEYWAY AND SETSCREW

REPLACEABLE CENTER KITS

FITTING FOR LUBRICATION



Selection

Universal Joints are used in many different types of applications and under a wide variety of operating conditions. No convenient method can be presented for determining ratings for all possible circumstances. Performance will be affected by vibration, shock loading, high temperature, dusty environment, etc.

The simplest solution to this problem is to provide approximate ratings of universal joints operating at various angles and speeds under normal service conditions.

The suggested ratings are for general use in applications where two joints are arranged at equal angles with the bearing pins of the intermediate yokes in line with each other.

Service torque ratings of the two sizes of BOS-trong Needle Bearing universals are listed in tables. Ratings for intermediate speeds and/or angles not shown may be found by interpolation.

Load Data

APPROXIMATE TORQUE RATINGS (LB. INS.)

Speed RPM	UJAS Series						UJNL Series					
	Operating Angle* – Degrees (Deviation from Straight Line)						Operating Angle† – Degrees (Deviation from Straight Line)					
	Up to 3°	5°	8°	12°	20°	30°	Up to 3°	5°	8°	12°	20°	30°
1800	610	515	440	—	—	—	845	710	610	—	—	—
1200	700	590	505	435	—	—	965	815	695	600	—	—
900	770	650	555	480	365	—	1060	895	765	660	500	—
600	880	740	635	545	415	260	1210	1020	875	755	575	355
300	1110	935	800	690	525	325	1530	1290	1100	950	725	450
200	1270	1070	915	790	600	370	1750	1480	1260	1090	825	515
100	1600	1350	1150	995	755	470	2210	1860	1590	1370	1040	645
50	2020	1700	1450	1250	950	590	2780	2350	2000	1730	1310	815
25	2540	2140	1830	1580	1200	745	3500	2960	2530	2180	1650	1020
10	3450	2900	2480	2140	1630	1010	4760	4010	3430	2960	2250	1390

NON-OPERATING FLEX-ANGLE—90°

*Maximum Angles (Momentary)—45°

†Maximum Angle (Momentary)—35°

Universal Joints

UJAS/UJNL Series BOS-Trong®

Cast Steel



All joints are furnished with keyways and setscrews.

DIMENSION IN INCHES

Overall Length	Bore		Hub Dia.		App. Wt. (Lbs.)	Catalog Number	Item Code
	Hub-A	Hub-B	Hub-A	Hub-B			
UJAS SERIES							
SWING DIAMETER 2-1/2"							
5	5/8	5/8	1-5/8	1-5/8	2	UJAS 10-10	G01409
		3/4		1-5/8		UJAS 10-12	G01410
		13/16				UJAS 10-13	G01411
		7/8				UJAS 10-14	G01412
		15/16				UJAS 10-15	G01413
		1				UJAS 10-16	G01414
		1-1/8		2-1/4		UJAS 10-18	G01415
5	3/4	3/4	1-5/8	1-5/8	2	UJAS 12-12	G01416
		13/16		1-5/8		UJAS 12-13	G01417
		7/8				UJAS 12-14	G01418
		15/16				UJAS 12-15	G01419
		1				UJAS 12-16	G01420
		1-1/8		2-1/4		UJAS 12-18	G01421
5	13/16	13/16	1-5/8	1-5/8	2	UJAS 13-13	G01422
		7/8		1-5/8		UJAS 13-14	G01423
		15/16				UJAS 13-15	G01424
		1				UJAS 13-16	G01425
		1-1/8		2-1/4		UJAS 13-18	G01426
5	7/8	7/8	1-5/8	1-5/8	2	UJAS 14-14	G01427
		15/16		1-5/8		UJAS 14-15	G01428
		1				UJAS 14-16	G01429
		1-1/8		2-1/4		UJAS 14-18	G01430
5	15/16	15/16	1-5/8	1-5/8	2	UJAS 15-15	G01431
		1		1-5/8		UJAS 15-16	G01432
		1-1/8				UJAS 15-18	G01433
5	1	1	1-5/8	1-5/8	2	UJAS 16-16	G01434
		1-1/8		2-1/4		UJAS 16-18	G01435
5	1-1/8	1-1/8	2-1/4	2-1/4	3	UJAS 18-18	G01436
UJNL SERIES							
SWING DIAMETER 2-3/4"							
5-1/2	1	1	2	2	3-3/4	UJNL 16-16	17354
		1-1/8		2-1/4		UJNL 16-18	17356
		1-3/16				UJNL 16-19	17358
		1-1/4				UJNL 16-20	17360
		1-3/8				UJNL 16-22	17362
		1-7/16				UJNL 16-23	17364
		1-1/2				UJNL 16-24	17366
5-1/2	1-1/8	1-1/8	2-1/4	2-1/4	3-3/4	UJNL 18-18	17368
		1-3/16		2-1/4		UJNL 18-19	17370
		1-1/4				UJNL 18-20	17372
		1-3/8				UJNL 18-22	17374
		1-7/16				UJNL 18-23	17376
		1-1/2				UJNL 18-24	17378
5-1/2	1-3/16	1-3/16	2-1/4	2	3-1/4	UJNL 19-19	17380
		1-1/4		2-1/4		UJNL 19-20	17382
		1-3/8				UJNL 19-22	17384
		1-7/16				UJNL 19-23	17386
		1-1/2				UJNL 19-24	17388
5-1/2	1-1/4	1-1/4	2-1/4	2	3-1/4	UJNL 20-20	17390
		1-3/8		2-1/4		UJNL 20-22	17392
		1-7/16				UJNL 20-23	17394
		1-1/2				UJNL 20-24	17396
5-1/2	1-3/8	1-3/8	2-1/4	2-1/4	3-1/4	UJNL 22-22	17398
		1-7/16		2-1/4		UJNL 22-23	17400
		1-1/2				UJNL 22-24	17402
5-1/2	1-7/16	1-7/16	2-1/4	2-1/4	3-1/4	UJNL 23-23	17404
		1-1/2		2-1/4		UJNL 23-24	17406
5-1/2	1-1/2	1-1/2	2-1/4	2-1/4	3-1/4	UJNL 24-24	17408

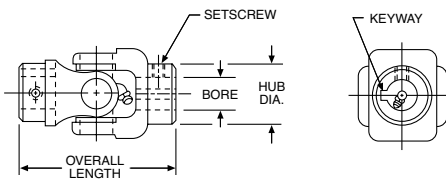

STANDARD TOLERANCES

DIMENSIONS		TOLERANCE
Bore	All	+ .002 - .000

Reference Pages

Lubrication—320

Mounting—320

ORDERING INFORMATION

Joints can also be ordered in various combinations of round, square or hex holes. To order the combination desired, specify "UJAS" or "UJNL" and hole size and type as listed in table of Yokes, Page 111. Use "S" for square and "H" for hexagon.

UJYS/UJL Series Cast Steel

STANDARD TOLERANCES

DIMENSION		TOLERANCE
Bore	Round	+.002- .000
	Square	3/4-13/16 +.000-+.002 7/8-1-1/2 +.001 +.003
	Hexagon	+.002 +.004

Yokes

These yokes are for assembly with UJASC/UJLC Center Kits.

All yokes are furnished with a 3/8-16 hex socket setscrew otherwise noted.

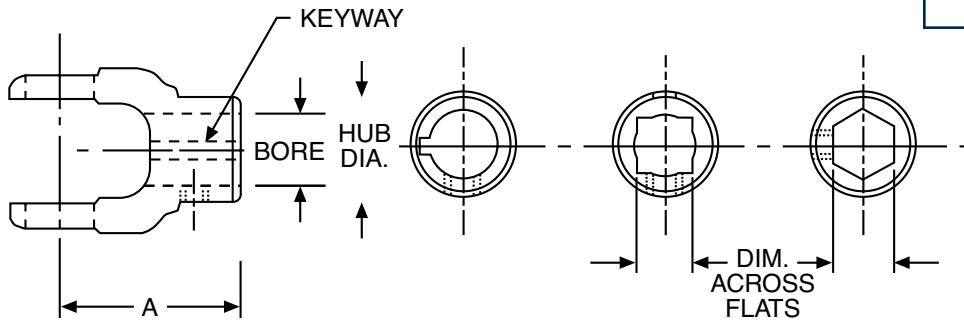

ALL DIMENSIONS IN INCHES

A	Round Bores							Square Bores							Hexagon Bores			
	Bore	Hub Dia.	Keyway	Setscrew Location	Approx. Weight (Lbs.)	Catalog Number	Item Code	Dim. Across Flats	Hub Dia.	Approx. Weight (Lbs.)	Setscrew Location	Catalog Number	Item Code	Setscrew Location	Catalog Number	Item Code		
UJYS Series																		
2-1/2	0.625	1.63	3/16x3/32	(4)	3/4	UJYS 10	G01437	—	—	—	—	—	—	—	—	—		
	0.750		3/16x3/32, (5)	(3)		UJYS12	G01438	0.750	1.63	3all4	(3)	UJYS 12S	G01444	—	—	—		
	0.813		1/4x1/8, (5)	(3)		UJYS 13	G01439	—	—	—	—	—	—	—	—	—		
	0.875		(1)	(4)		UJYS14	G01440	.875 (7)	2.25	3/4	(4)	UJYS 14S	G01445	(3)	UJYS 14H	G01447		
	0.938		1/4x1/8, (5)	5/16-24, (4)		UJYS15	G01441	—	—	—	—	—	—	—	—	—		
	1.000		(1)			UJYS16	G01442	1.000 (7)	2.25	1	(4)	UJYS 16S	G01446	—	—	—		
	1.125		(2)			(4)	1-1/4	UJYS18	G01443	—	—	—	—	—	—	—	—	
UJL Series																		
2-3/4	1.000	2.00	1/4x1/8 (3)	(4)	1-1/2	UJL16	17424	1.000	2.00	1-1/2	(4)	UJL16S	17450	—	—	—		
	1.125	2.25	1/4x1/8	(5)	1-1/4	UJL18	17426	1.126	2.25	1-1/2	(5)	—	—	—	—	—		
	1.188					UJL19	17428	(1) Two keyways 180° apart, 3/16x3/32 and 1/4x1/8										
	1.250					UJL20	17430	(2) Two keyways 180° apart, 1/4x1/8 and 5/16x5/32										
	1.375					5/16x5/32	UJL22	17432	(3) Located 90° from shown									
	1.438					3/8x3/16	UJL23	17434	(4) Located as shown									
	1.500						(4), (6)	UJL24	17436	(5) Located 180° from shown								
										(6) Additional setscrew over keyway								
										(7) Has both .875 and 1.000 square bores @ 45°								

Center Kits

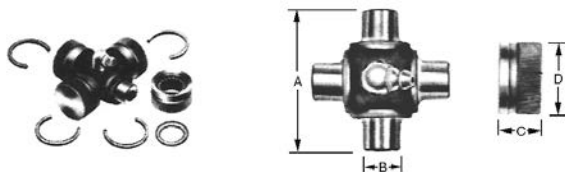

Double Yokes

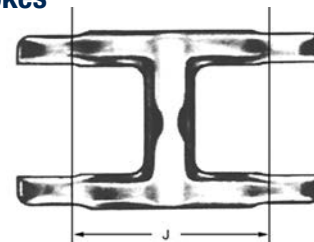

ALL DIMENSIONS IN INCHES

Center Kits*							Double Yokes				
A	B	C	D	Approx. Weight (Lbs.)	Catalog Item	Item Code	J	Maximum Operating Angle	Approx. Weight (Lbs.)	Catalog Number	Item Code
UJYS Series**							UJYS Series**				
1-61/64	.547	.594	0.938	1/2	UJASC	G06130	2-1/2	15°	1	UJYSD	G06133
UJS Series***							UJS Series***				
1-61/64	.547	.594	0.969	1/2	UJSC-969	G06146	2-1/2	15°	1	UJSD	17460
UJL Series							—				
2-5/16	.644	.625	1.0625	3/4	UJLC	17466	—	—	—	—	—

* Center kits include 1 cross, 4 bearings and 4 lock rings.

** Yokes from UJYS Series and double yoke UJYSD are only compatible with UJASC center kit.

*** Yokes from UJS Series (old series) and double yoke UJSD are only compatible with UJSC-969 center kit.

Universal Joints

JP Series Single and Double

Molded Type



MOLDED DELRIN BODY provides vibration dampening and electrical insulation.

MAX. ANGULAR DISPLACEMENT — Single 45° — Double 90°

MAX. AMBIENT TEMPERATURE — 180°F

COMPLETE WITH SETSCREWS

STANDARD TOLERANCES

DIMENSIONS		TOLERANCE
Bore	All	+ .001 - .000

Reference Pages

Mounting — 320

Materials

Delrin Body
Nickel Plated Brass Spider and Insert

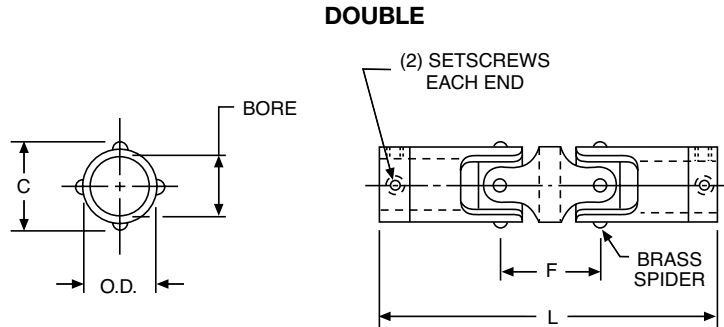
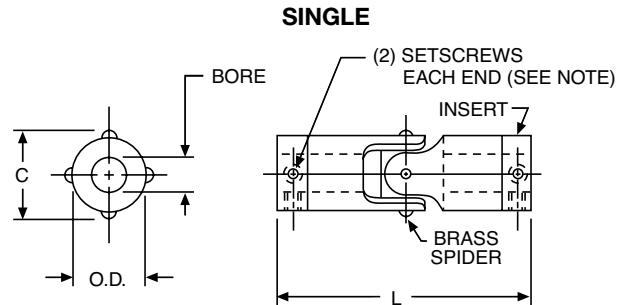

**ALL DIMENSIONS IN INCHES
ORDER BY CATALOG NUMBER OR ITEM CODE**

Bore	Bore Depth (Typical)	O.D.	C	L		Double Only		Setscrew	Single		Double	
				Single	Double	F	Max. Parallel Offset		Catalog Number	Item Code	Catalog Number	Item Code
1/8	.39	1/4	.27	1-3/64	1-23/64	5/16	.22	#4 - 40	JP25 - 1/8*	54194	JPD25 - 1/8	54202
1/8	.52	3/8	.41	1-31/64	2	17/32	.36	#4 - 40	JP37 - 1/8*	54195	JPD37 - 1/8	54203
3/16	.63	1/2	.54	1-13/16	2-7/16	5/8	.43	#6 - 32	JP37 - 3/16	54196	JPD37 - 3/16	54204
1/4	.63	1/2	.54	1-13/16	2-7/16	5/8	.43	#6 - 32	JP50 - 3/16	54197	JPD50 - 3/16	54205
1/4	.63	1/2	.54	1-13/16	2-7/16	5/8	.43	#6 - 32	JP50 - 1/4	54198	JPD50 - 1/4	54206
5/16	.86	5/8	.68	2-41/64	3-33/64	7/8	.61	#8 - 32	JP62 - 1/4	54199	JPD62 - 1/4	54207
3/8	.86	5/8	.68	2-41/64	3-33/64	7/8	.61	#8 - 32	JP62 - 5/16	54200	JPD62 - 5/16	54208
3/8	.86	5/8	.68	2-41/64	3-33/64	7/8	.61	#8 - 32	JP62 - 3/8	54201	JPD62 - 3/8	54209

* One setscrew each end.

LOAD DATA

Basic Size	Maximum Torque† (Lb. Ins.)	
	Single	Double
25	5	2.5
37	16	7
50	26	12
62	60	47

† This is the ultimate or breaking torque for static, zero angle conditions. Actual operating conditions will dictate use of significantly lower values.

E

JPE Series With Slide Extension Molded Type

MOLDED DELRIN BODY — provides vibration dampening and electrical insulation.

MAX. ANGULAR DISPLACEMENT — Single 45° — Double 90°

MAX. AMBIENT TEMPERATURE — 180°F

COMPLETE WITH SETSCREWS



STANDARD TOLERANCES

DIMENSIONS		TOLERANCE
Bore	All	+ .001 - .000

Reference Pages

Mounting — 312

Materials

Delrin Body
Nickel Plated Brass Spider and Insert

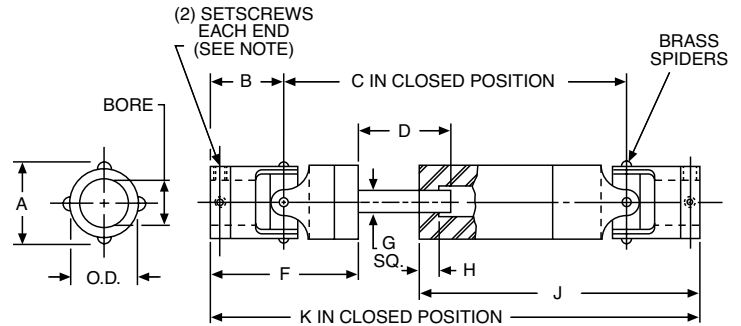

ALL DIMENSIONS IN INCHES ORDER BY CATALOG NUMBER OR ITEM CODE

Bore	Bore Depth (Typical)	O.D.	A	B	C	D	E	F	G (Sq.)	H	J	K	Setscrew	Catalog Number	Item Code
1/8	.52	3/8	.41	.74	2-59/64	1-1/8	-	1-47/64	3/16	23/64	2-43/64	4-13/32	#4 - 40	JPE37 - 1/8	54210
3/16	.52	3/8	.41	.74	2-59/64	1-1/8	-	1-47/64	3/16	23/64	2-43/64	4-13/32	#4 - 40	JPE37 - 3/16	54211
3/16	.63	1/2	.54	.91	2-23/64	1-1/8	3/8	1-34/64	3/16	23/64	2-9/16	4-11/64	#6 - 32	JPE50 - 3/16	54212
1/4	.63	1/2	.54	.91	2-23/64	1-1/8	3/8	1-34/64	3/16	23/64	2-9/16	4-11/64	#6 - 32	JPE50 - 1/4	54213

LOAD DATA

Basic Size	Maximum Recommended Torque (Lb. Ins.)	
	Closed	Open
JPE37	8	5
JPE50	14	10

†This is the ultimate or breaking torque for static, zero angle conditions. Actual operating conditions will dictate use of significantly lower values.

Setscrew Collars

SC/SSC Series

Steel and Stainless Steel

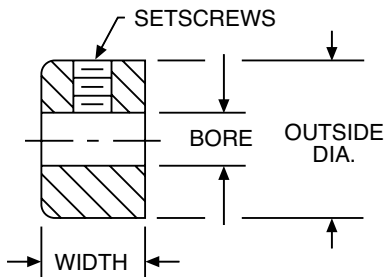

STANDARD TOLERANCES

DIMENSIONS		TOLERANCE
Bore	1/8-1	+ .001 + .003
	1-1/16-3	+ .001 + .004

Materials

Stainless Steel—Type 303 Austenitic.
Steel—Low Carbon, Zinc plated finish.

STEEL BORE SIZES FROM 1/8" TO 3"

STAINLESS STEEL BORE SIZES FROM 1/8" TO 2"

STAINLESS STEEL COLLARS ARE CORROSION-RESISTANT AND NON-MAGNETIC suitable for temperatures up to 800°F. Ideal for applications requiring hygienic cleanliness.

ALL COLLARS COMPLETE WITH STANDARD HOLLOW POINT SETSCREWS.

ALL DIMENSIONS IN INCHES
ORDER BY CATALOG NUMBER OR ITEM CODE

Bore	Outside Diameter	Width	Alloy Steel		Stainless Steel	
			Catalog Number	Item Code	Catalog Number	Item Code
1/8	3/8	1/4	SC12	67697	SSC12	67740
3/16	7/16	1/4	SC18	67698	SSC18	67741
1/4	1/2	5/16	SC25	67699	SSC25	67742
5/16	5/8	11/32	SC31	67700	SSC31	67743
3/8	3/4	3/8	SC37	67701	SSC37	67744
7/16	7/8	7/16	SC43	67702	—	—
1/2	1	7/16	SC50	67703	SSC50	67745
9/16	1	7/16	SC56	67704	—	—
5/8	1-1/8	1/2	SC62	67705	SSC62	67746
11/16	1-1/4	9/16	SC68	67706	—	—
3/4	1-1/4	9/16	SC75	67707	SSC75	67747
13/16	1-1/4	9/16	SC81	67708	—	—
7/8	1-1/2	9/16	SC87	67709	SSC87	67748
15/16	1-5/8	9/16	SC93	67710	—	—
1	1-1/2	5/8	SC100	67711	SSC100	67749
1-1/16	1-3/4	5/8	SC106	67712	—	—
1-1/8			SC112	67713	SSC112	67784
1-3/16	2	11/16	SC118	67714	—	—
1-1/4			SC125	67715	SSC125	67785
1-5/16	2-1/8	11/16	SC131	67716	—	—
1-3/8			SC137	67717	—	—
1-7/16	2-1/4	3/4	SC143	67718	—	—
1-1/2			SC150	67719	SSC150	67788
1-9/16	2-1/2	13/16	SC156	67720	—	—
1-5/8			SC162	67721	—	—
1-11/16			SC168	67722	—	—
1-3/4	2-5/8	7/8	SC175	67723	SSC175	67789
1-13/16			SC181	67724	—	—
1-7/8			SC187	67725	—	—
1-15/16	3	7/8	SC193	67726	—	—
2			SC200	67727	SSC200	67790
2-1/8			SC212	67728	—	—
2-3/16	3-1/4	15/16	SC218	67729	—	—
2-1/4			SC225	67730	—	—
2-5/16			SC231	67731	—	—
2-3/8			SC237	67732	—	—
2-7/16	3-1/2	1	SC243	67733	—	—
2-1/2			SC250	67734	—	—
2-9/16	3-3/4	1	SC256	67735	—	—
2-11/16	4	1-1/8	SC268	67736	—	—
2-3/4			SC275	67737	—	—
2-15/16	4	1-1/8	SC293	67738	—	—
3			SC300	67739	—	—

Clamping Collars

CSC/CSSC Series

Threaded Type; Steel and Stainless Steel

DESIGN PROVIDES CONVENIENT SETTING, ADJUSTING AND REMOVAL
prevents shaft damage.
OSHA CONFORMANCE collars have completely recessed screw head.
BORE THREADS FROM 10–32 TO 200–12



ORDER BY CATALOG NUMBER OR ITEM CODE

Bore Thread	Outside Dia.	Width	Clamp Screws	Steel		Stainless Steel	
				Catalog Number	Item Code	Catalog Number	Item Code
10-32	11/16	1/4	4-40	CSC10-32	49237	—	—
1/4-20	13/16	1/4	4-40	CSC25-20	49238	CSSC25-20	49265
1/4-28				CSC25-28	49239	—	—
5/16-18				CSC31-18	49240	—	—
5/16-24				CSC31-24	49241	—	—
3/8-16	1-1/16	5/16	6-32	CSC37-16	49242	CSSC37-16	49269
3/8-24				CSC37-24	49243	CSSC37-24	49270
1/2-13	1-1/4	3/8	8-32	CSC50-13	49244	CSSC50-13	49271
1/2-20				CSC50-20	49245	CSSC50-20	49272
5/8-11	1-1/2	13/32	10-32	CSC62-11	49246	CSSC62-11	49273
5/8-18				CSC62-18	49247	CSSC62-18	49274
3/4-10	1-3/4	1/2	1/4-28	CSC75-10	49248	CSSC75-10	49275
3/4-16				CSC75-16	49249	CSSC75-16	49276
7/8-9	1-7/8	1/2	1/4-28	CSC87-9	49250	—	—
7/8-14				CSC87-14	49251	—	—
1-8	2	1/2	1/4-28	CSC100-8	49252	CSSC100-8	49279
1-14				CSC100-14	49253	CSSC100-14	49280
1-1/8-7	2-1/8	1/2	1/4-28	CSC125-7	49254	—	—
1-1/8-12				CSC112-12	49255	—	—
1-1/4-7	2-1/4	1/2	1/4-28	CSC125-7	49256	—	—
1-1/4-12				CSC125-12	49257	CSSC125-12	49284
1-1/2-6	2-1/2	1/2	1/4-28	CSC150-6	49258	—	—
1-1/2-12				CSC150-12	49259	—	—
1-3/4-16	3	5/8	5/16-24	CSC175-16	49260	—	—
2-12	3-1/4	5/8	5/16-24	CSC200-12	49261	—	—

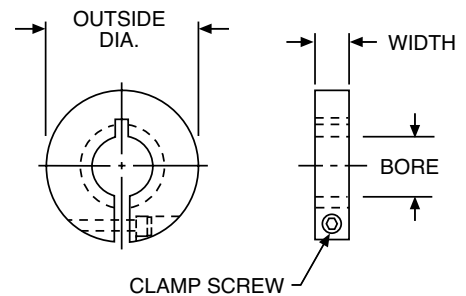

Materials

Steel—Low Carbon,
Black Oxide Finish
Stainless—Type 303 Austenitic

Clamping Collars

CSC/CSSC/CASC Series

1 Piece Type Steel, Stainless Steel and Aluminum

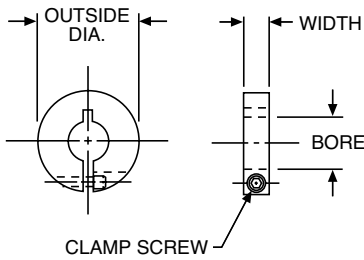
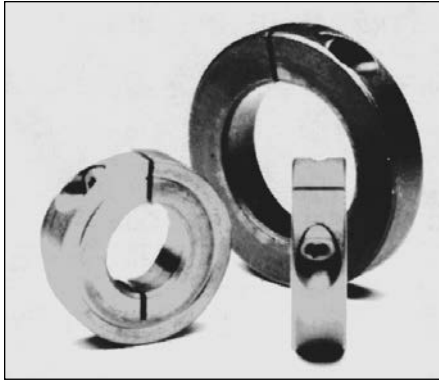

STANDARD TOLERANCES

DIMENSIONS		TOLERANCE
Bore	All	+ .003 - .000

Materials

Steel—Low Carbon
 Black Oxide Finish Stainless—Type 303
 Austenitic

Load Data

Capacity is based on a standard steel, one-piece collar mounted with recommended screw torque on a lightly oiled shaft. Capacity is load to move collar .010". Data shown is for guidance only. In applications involving control of axial loads, capacity should be determined experimentally on actual parts involved.

DESIGN PROVIDES CONVENIENT SETTING, ADJUSTING AND REMOVAL prevents shaft damage.
OSHA CONFORMANCE collars have completely recessed screw head.
BORE THREADS FROM 1/8" TO 3"

ALL DIMENSIONS IN INCHES ORDER BY CATALOG NUMBER OR ITEM CODE

Bore	O.D.	Width	Clamp Screws	Steel		Stainless Steel		Aluminum	
				Catalog Number	Item Code	Catalog Number	Item Code	Catalog Number	Item Code
1/8	13/16	1/4	4-40	CSC12	49000	CSSC12	49094	—	—
3/16				CSC18	49001	CSSC18	49095	CASC18	49048
1/4				CSC25	49002	CSSC25	49096	CASC25	49049
5/16				CSC31	49003	CSSC31	49097	CASC31	49050
3/8	1-1/16	5/16	6-32	CSC37	49004	CSSC37	49098	CASC37	49051
7/16				CSC43	49005	CSSC43	49099	—	—
1/2	1-1/4	3/8	8-32	CSC50	49006	CSSC50	49100	CASC50	49053
9/16				CSC56	49007	CSSC56	49101	CASC56	49054
5/8	1-1/2	13/32	10-32	CSC62	49008	CSSC62	49102	CASC62	49055
11/16				CSC68	49009	—	—	—	—
3/4	1-3/4			CSC75	49010	CSSC75	49104	CASC75	49057
13/16				CSC81	49011	—	—	—	—
7/8	1-7/8			CSC87	49012	CSSC87	49106	CASC87	49059
15/16				CSC93	49013	CSSC93	49107	—	—
1	2			CSC100	49014	CSSC100	49108	CASC100	49061
1-1/16				CSC106	49015	CSSC106	49109	—	—
1-1/8	2-1/8	1/2	1/4-28	CSC112	49016	CSSC112	49110	CASC125	49065
1-3/16				CSC118	49017	CSSC118	49111	—	—
1-3/8	2-3/8			CSC137	49020	—	—	—	—
1-5/16				CSC143	49021	CSSC143	49115	—	—
1-1/2	2-1/2			CSC150	49022	CSSC150	49116	CASC150	49069
1-9/16				CSC156	49023	—	—	—	—
1-5/8	3	5/8	5/16-24	CSC162	49024	—	—	—	—
1-11/16				CSC168	49025	—	—	—	—
1-3/4				CSC175	49026	—	—	CASC175	49073
1-7/8	3-1/4	5/8	5/16-24	CSC187	49028	—	—	—	—
1-15/16				CSC193	49029	CSSC193	49123	—	—
2				CSC200	49030	CSSC200	49124	CASC200	49077
2-3/16	3-1/2			CSC218	49033	—	—	—	—
2-1/4				CSC225	49034	—	—	—	—
2-3/8				CSC237	49036	—	—	—	—
2-7/16	4			CSC243	49037	—	—	—	—
2-1/2				CSC250	49038	—	—	—	—
2-5/8				CSC262	49040	—	—	—	—
2-11/16	4-1/4	3/4	3/8-24	CSC268	49041	—	—	—	—
2-3/4				CSC275	49042	—	—	—	—
2-7/8				CSC287	49044	—	—	—	—
2-15/16	4-1/2			CSC293	49045	—	—	—	—
3				CSC300	49046	—	—	—	—

DIMENSION IN INCHES

Bore	Axial Load Capacity (Lbs.)	Screw Size	Recommended Screw Torque (Lb. Ins.)	
			Steel	Stainless Steel
1/8-5/16	400	4-40	20	16
3/8-7/16	600	6-32	30	24
1/2-9/16	1400	8-32	55	35
5/8-11/16	1800	10-32	90	72
3/4-1-9/16	4000	1/4-28	220	170
1-5/8-2-3/8	6500	5/16-24	435	340
2-7/16-3	8500	3/8-24	710	550

E

Clamping Collars

2SC/2SSC Series

2 Piece Type Steel, Stainless Steel and Aluminum

DESIGN PROVIDES CONVENIENT SETTING, ADJUSTING AND REMOVAL

prevents shaft damage.

OSHA CONFORMANCE collars have completely recessed screw head.

BORE THREADS FROM 1/4" TO 3"

ALL DIMENSIONS IN INCHES
ORDER BY CATALOG NUMBER OR ITEM CODE

Bore	O.D.	Width	Clamp Screws	Steel		Stainless Steel	
				Catalog Number	Item Code	Catalog Number	Item Code
1/4 5/16	13/16	1/4	4-40	2SC25 2SC31	49143 49144	2SSC25 2SSC31	49190 49191
3/8 7/16	1-1/16	5/16	6-32	2SC37 2SC43	49145 49146	2SSC37 2SSC43	49192 49193
1/2 9/16	1-1/4	3/8	8-32	2SC50 2SC56	49147 49148	2SSC50 2SSC56	49194 49195
5/8 11/16	1-1/2	13/32	10-32	2SC62 2SC68	49149 49150	2SSC62 2SSC68	49196 49197
3/4 13/16	1-3/4	1/2	1/4-28	2SC75	49151	2SSC75	49198
7/8 15/16	1-7/8			2SC81	49152	—	—
1 1-1/16	2			2SC87	49153	2SSC87	49200
1-1/8 1-3/16	2-1/8			2SC93	49154	—	—
1-1/4 1-5/16	2-1/4			2SC100	49155	2SSC100	49202
1-3/8 1-7/16	2-3/8			2SC106	49156	2SSC106	49203
1-1/2 1-9/16	2-1/2			2SC112	49157	2SSC112	49204
1-5/8 1-11/16	3			2SC118	49158	2SSC118	49205
1-3/4 1-13/16				2SC125	49159	2SSC125	49206
2 2-1/16				2SC131	49160	2SSC131	49207
2-1/8 2-3/16	3-1/4	5/8	5/16-24	2SC137	49161	—	—
2-1/4 2-3/8				2SC143	49162	2SSC143	49209
2-7/16 2-1/2				2SC150	49163	2SSC150	49210
2-5/8 2-11/16				2SC156	49164	—	—
2-3/4 2-7/8	4-1/4	3/4	3/8-24	2SC162	49165	—	—
2-7/8 2-15/16				2SC168	49166	—	—
3 3				2SC175	49167	—	—
				2SC187	49169	2SSC187	49216
				2SC193	49170	2SSC193	49217
				2SC200	49171	2SSC200	49218
				—	—	—	
				2SC212	49173	—	—
				2SC218	49174	—	—
				2SC225	49175	—	—
				2SC237	49177	—	—
				2SC243	49178	—	—
				2SC250	49179	—	—
				2SC262	49181	—	—
				2SC268	49182	—	—
				2SC275	49183	—	—
				2SC287	49185	—	—
				2SC293	49186	—	—
				2SC300	49187	—	—

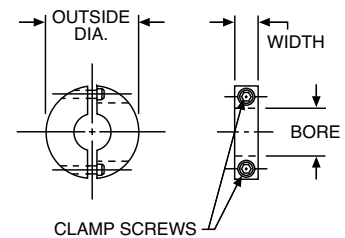

STANDARD TOLERANCES

DIMENSIONS		TOLERANCE
Bore	All	+ .003 - .000

Materials

Steel—Low Carbon, Black Oxide Finish
Stainless—Type 303 Austenitic

Load Data

Capacity is based on a standard steel, one-piece collar mounted with recommended screw torque on a lightly oiled shaft. Capacity is load to move collar .010". Data shown is for guidance only. In applications involving control of axial loads, capacity should be determined experimentally on actual parts involved.

DIMENSION IN INCHES

Bore	Axial Load Capacity (Lbs.)	Screw Size	Recommended Screw Torque (Lb. Ins.)	
			Steel	Stainless Steel
1/8-5/16	400	4-40	20	16
3/8-7/16	600	6-32	30	24
1/2-9/16	1400	8-32	55	35
5/8-11/16	1800	10-32	90	72
3/4-1-9/16	4000	1/4-28	220	170
1-5/8-2-3/8	6500	5/16-24	435	340
2-7/16-3	8500	3/8-24	710	550

Thrust Washers

Steel and Stainless Steel

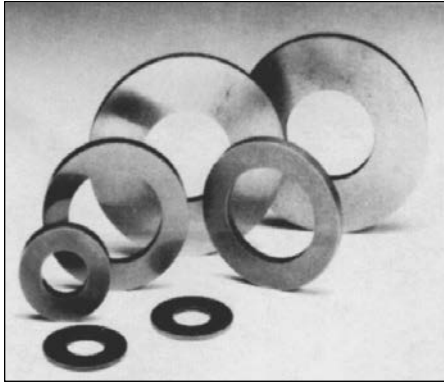

HARDENED AND GROUND STEEL BORE SIZES FROM 3/16" TO 2"
STAINLESS STEEL BORE SIZES FROM 3/16" TO 1/2"

ALL DIMENSIONS IN INCHES
ORDER BY CATALOG NUMBER OR ITEM CODE

STANDARD TOLERANCES

DIMENSIONS		TOLERANCE
Bore	06700 Series	+ .0015 + .0070
	18000 Series	+ .002 + .007
O.D.	06700 Series	+ .000 - .005
	18000 Series	± .030
Thickness	All	+ .000 - .005

Bore	Outside Diameter	Thick-ness	Catalog Number
HARDENED STEEL			
3/16	9/32	1/16	18800
	3/8	1/16	18804
		3/32	18806
	7/16	1/16	06724*
1/4	1/2	1/16	18808
		3/32	18810
	9/16	1/16	06726*
5/16	5/8	5/64	06728*
		1/16	18812
		1/8	18814
3/8	5/8	1/16	18816
		1/8	18818
	11/16	3/32	06730*
7/16	7/8	1/16	18820
		5/32	18822
1/2	3/4	1/16	18824
		1/8	18826
	7/8	1/8	06734*
	1-1/8	1/16	18828
5/32		18830	
	1-1/4	3/16	18832
9/16	1-3/8	3/32	18834
		3/16	18836
5/8	25/32	1/16	18838
		1/8	18840
	1-1/4	3/32	18842
		3/16	18844
	1-3/8	3/16	18846
	1-1/2	3/32	18848
3/16		18850	
3/4	1	3/32	18852
	1-5/16	3/32	18854
		3/16	18856
	1-5/8	3/16	18858
		1/8	18860
	1-3/4	3/16	18862
2		3/16	18864
	2	3/16	18866

Bore	Outside Diameter	Thick-ness	Catalog Number
HARDENED STEEL			
7/8	1-3/16	3/32	18868
	2	1/8	18870
	2	3/16	18872
	2-1/4	3/16	18874
1	1-9/16	1/8	18876
		3/16	18878
	2	1/8	18880
		3/16	18882
	2-1/4	9/64	18884
	3/16	18886	
	2-1/2	1/4	18888
1-1/16	2-1/2	1/4	18890
1-1/8	2-1/2	1/4	18894
1-3/16	2	3/16	18896
1-1/4	2	9/64	18898
		3/16	18922
	2-7/16	9/64	18900
		1/4	18924
	2-3/4	9/64	18902
	3	1/4	18904
1-5/16	2-3/4	1/4	18906
1-3/8	3	5/32	18908
		1/4	18910
1-1/2	3	5/32	18912
		1/4	18914
	3-1/4	1/8	18916
2	4	5/32	18918
		5/16	18920
STAINLESS STEEL†			
3/16	7/16	1/16	06760
1/4	9/16	1/16	06762
5/16	5/8	5/64	06764
3/8	11/16	3/32	06766
1/2	7/8	1/8	06770

*These washers also listed with AO Bearings.
 †These washers also listed with SAO Bearings.

Bushings

Soft Steel

BORE SIZES FROM 3/16" TO 1-1/4"

MULTI-PURPOSE BUSHINGS suitable for use as hole reducers, spacers, standoffs or slip bushings.

ADAPTABLE FOR OTHER USES including wear sleeves, liners or cutting arbor studs.

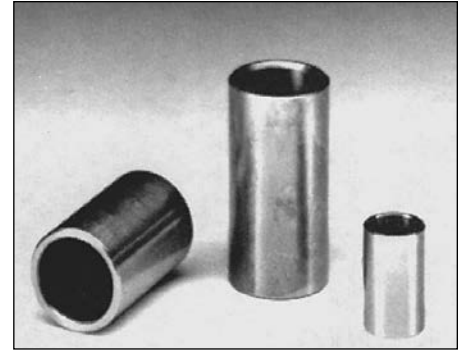

ALL DIMENSIONS IN INCHES ORDER BY CATALOG NUMBER

Bore	Outside Diameter	Thick-ness	Catalog Number	
3/16	1/4	5/8	18510	
	5/16		18512	
	3/8		18516	
1/4	5/16	5/8	18514	
	3/8		18518	
	1/2	3/4	18522	
5/16	1/2	1	18524	
	3/8	5/8	18520	
	1/2		3/4	18526
3/8	1/2	1	18528	
	5/8	3/4	18530	
	1	1	18532	
7/16	1/2	3/4	18534	
	5/8	1-1/4	18536	
	3/4	3/4	18538	
1/2	5/8	1	18542	
	1	1-1/4	18544	
	1-1/4	1	18546	
5/8	3/4	3/4	18554	
	1	1	18556	
	1-1/4	1-1/4	18560	
3/4	7/8	1-1/4	18562	
	1	1-1/4	18568	
	1-1/2	1-1/2	18574	
7/8	1-3/8	2	18626	
	1-1/2	1-1/2	18606	
	1	1-1/2	18576	
1	1-1/4	2	18596	
	1-3/8		18602	
	2		18622	
1-1/8	1-1/4	2	18598	
1-1/4	1-3/8	2	18604	
	1-1/2		1-1/2	18614
	2		3	18624

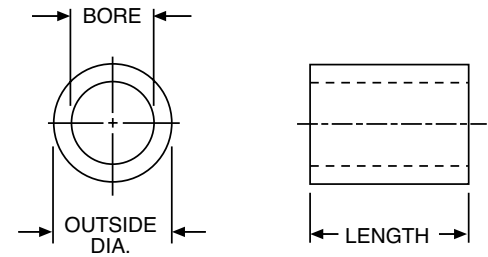

STANDARD TOLERANCES

DIMENSIONS		TOLERANCE
BORE	All	± .0005
O.D.	Up to 1-1/4	+ .0005 +.0015
	Over 1-1/4	+ .001 +.002
LENGTH	Up to 1"	+ .000 -.007
	Over 1"	+ .000 -.010

Grooved Pulleys

G1200

Round Belt Type

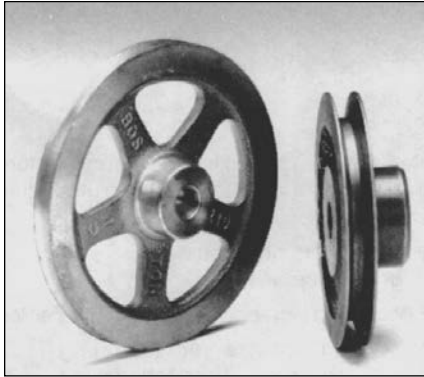

**BRASS IRON AND STEEL
BORE SIZES FROM 3/16" TO 3/4"
COMPLETE WITH STANDARD SETSCREWS**

**ALL DIMENSIONS IN INCHES
ORDER BY CATALOG NUMBER OR ITEM CODE**

Bore	Outside Diameter	Hub Dia.	Project	V Groove	Style	Catalog Number	Item Code
BRASS—3/16" ROUND BELT (or smaller)—1/4" FACE							
3/16	1/2 7/8	1/2 5/8	1/4	74° 46°	Plain	G1214 G1215	18700 18702
1/4	1 1-1/2	5/8	5/16	46°	Plain	G1216 G1217	18704 18706
5/16	2 3 4	5/8 3/4 3/4	5/16	46°	Webbed Spoked Spoked	G1218 G1219 G1220	18708 18710 18712
IRON†—3/8" ROUND BELTS (or smaller)—1/2" FACE							
1/2	1	15/16	1/2	53°	Plain	G1202	18718
	1-1/2	1				G1203	18720
	2	1			G1204	18722	
	3	1-1/4			G1205	18724	
5/8	4	1-5/8	3/4		Webbed	G1206	18726
	5					G1207	18728
	6					G1208	18730
3/4	8	1-3/4	1		Spoked	G1209	18732

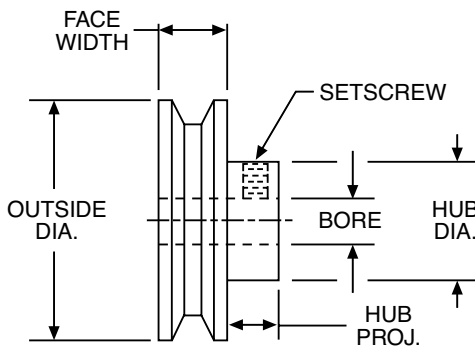

†Outside diameter, sides, grooves, hole and ends of hub finished.

STANDARD TOLERANCES

DIMENSIONS		TOLERANCE
BORE	All	+ .001 - .000

Miniature Timing Belts and Pulleys

Miniature HTD Timing Belt Drives

Basic Construction

Timing belts are essentially flat belts with the addition of evenly spaced teeth along the surface that contacts toothed pulleys. Power is transmitted smoothly and without slippage. Pulley pitch diameters are larger than their outside diameters and the belt pitch lines lie within the flat portion. Tension members are molded in the flat portion to serve as load-carrying elements. Miniature HTD timing belts have deep curvilinear tooth forms, as contrasted to trapezoidal for conventional timing belts. Greater strength, lower tooth pressures and decreased stress concentration result in superior performance.

Selection

The following general guidelines apply to selection of miniature HTD timing belts and pulleys:

Design with ample reserve horsepower capacity and apply the proper service factors.

The belt must have six or more teeth in engagement with the smaller pulley to carry rated Horsepower.

Avoid small pulley diameters where practical to assure satisfactory belt life.

Belt speed should not exceed 6500 feet per minute.

At least one pulley in the drive should be flanged.

For vertical shafts or where center distance exceeds eight times the smaller pulley diameter, both pulleys should be flanged.

Horsepower Rating Tables provide ratings for operation no more than ten hours per day under uniform loading. Selection procedures is as follows:

1. Select Service Factor for chart below.
2. Determine Design Horsepower.

Design Horsepower = Application Horsepower x Service Factor

3. Select small pulley and belt size from the rating tables, choosing a combination whose rating does not exceed the Design Horsepower.
4. For speed increasing applications an additional amount must be added to the Service Factor.
5. For speeds higher than shown in Rating Tables, consult factory.

SERVICE FACTORS

Load Classification	Service Factor
Uniform to 10 hrs./day	1.0
Uniform over 10 hrs./day Moderate Shock to 10 hrs./day	1.5
Moderate Shock over 10 hrs./day Heavy Shock to 10 hrs./day	2.0

SPEED-UP DRIVES

Ratio Range	Additional Factor
1 through 1.24	0
1.25 through 1.74	0.1
1.75 through 2.49	0.2
2.50 through 3.49	0.3
3.50 and over	0.4

Miniature Timing Belts and Pulleys

Miniature HTD Timing Belt Drives (Continued)

Horsepower Ratings

3mm Pitch—6mm Wide Belt

NUMBER OF GROOVES ON THE SMALL PULLEY

	10	11	12	14	15	16	18	20	22	24	25	28	30	32	
PD	.376	.414	.451	.526	.564	.602	.677	.752	.827	.902	.940	1.053	1.128	1.203	
RPM of Small Pulley	100	.005	.005	.006	.007	.008	.009	.010	.011	.012	.013	.013	.016	.019	.020
	300	.016	.017	.018	.021	.023	.025	.029	.033	.037	.040	.041	.048	.055	.059
	500	.022	.024	.027	.030	.032	.035	.039	.043	.048	.053	.055	.062	.066	.070
	700	.031	.035	.037	.042	.046	.049	.054	.061	.068	.075	.078	.087	.092	.098
	1160	.040	.045	.050	.056	.061	.066	.072	.078	.089	.097	.101	.113	.120	.127
	1500	.052	.058	.064	.072	.078	.085	.093	.101	.115	.125	.130	.145	.155	.165
	1750	.061	.068	.075	.085	.091	.099	.108	.117	.134	.146	.152	.170	.182	.194
	2500	.067	.074	.080	.091	.101	.107	.117	.134	.148	.161	.168	.192	.200	.213
	3500	.094	.103	.113	.127	.141	.151	.165	.188	.207	.226	.236	.268	.278	.296

3mm Pitch—9mm Wide Belt

NUMBER OF GROOVES ON THE SMALL PULLEY

	10	11	12	14	15	16	18	20	22	24	25	28	30	32	
PD	.376	.414	.451	.526	.564	.602	.677	.752	.827	.902	.940	1.053	1.128	1.203	
RPM of Small Pulley	100	.007	.008	.009	.011	.013	.014	.016	.017	.019	.021	.022	.025	.030	.032
	300	.025	.027	.029	.033	.036	.040	.046	.052	.059	.063	.066	.076	.087	.092
	500	.035	.038	.043	.048	.051	.055	.062	.068	.076	.084	.088	.098	.104	.111
	700	.049	.056	.059	.067	.073	.078	.085	.096	.107	.119	.124	.138	.146	.156
	1160	.063	.071	.079	.089	.097	.104	.114	.123	.141	.154	.160	.179	.190	.203
	1500	.082	.092	.101	.114	.123	.135	.147	.160	.182	.198	.206	.230	.246	.263
	1750	.097	.108	.119	.135	.144	.157	.171	.185	.212	.231	.241	.269	.289	.308
	2500	.106	.117	.127	.144	.160	.169	.185	.212	.235	.255	.266	.304	.317	.338
	3500	.149	.163	.179	.201	.223	.239	.262	.298	.328	.358	.372	.425	.441	.470

5mm Pitch—9mm Wide Belt

NUMBER OF GROOVES ON THE SMALL PULLEY

	11	12	14	15	16	18	20	22	24	25	28	30	
PD	.689	.752	.877	.940	1.003	1.128	1.253	1.379	1.504	1.566	1.754	1.880	
RPM of Small Pulley	100	.021	.024	.027	.030	.033	.039	.042	.045	.051	.053	.063	.069
	300	.063	.069	.081	.090	.096	.108	.126	.138	.153	.159	.186	.204
	500	.090	.099	.117	.126	.132	.150	.165	.183	.198	.206	.231	.249
	700	.129	.138	.162	.174	.186	.210	.231	.255	.279	.291	.324	.348
	1160	.162	.180	.207	.225	.240	.270	.300	.327	.360	.375	.420	.447
	1500	.210	.231	.270	.291	.309	.348	.387	.423	.465	.484	.543	.579
	1750	.243	.270	.315	.339	.360	.405	.453	.495	.540	.562	.633	.675
	2500	.267	.291	.342	.366	.393	.441	.492	.540	.588	.613	.687	.735
	3500	.372	.405	.477	.510	.549	.615	.690	.756	.822	.856	.960	1.03

Miniature Timing Belts and Pulleys

Miniature HTD Timing Belt Drives (Continued)

Horsepower Ratings

5mm Pitch—15mm Wide Belt

NUMBER OF GROOVES ON THE SMALL PULLEY

	11	12	14	15	16	18	20	22	24	28	30
PD	.689	.752	.877	.940	1.003	1.128	1.253	1.379	1.504	1.754	1.880
100	.038	.043	.049	.054	.060	.071	.076	.082	.093	.115	.126
300	.115	.126	.148	.164	.175	.197	.230	.252	.280	.340	.373
500	.164	.181	.214	.230	.241	.274	.302	.335	.362	.423	.456
700	.236	.252	.296	.318	.340	.384	.423	.467	.511	.593	.637
1160	.296	.329	.379	.412	.439	.494	.549	.599	.659	.769	.819
1500	.384	.423	.494	.533	.566	.637	.709	.775	.852	.995	1.06
1750	.445	.494	.577	.621	.649	.742	.830	.907	.989	1.16	1.23
2500	.489	.533	.626	.670	.720	.808	.901	.989	1.07	1.25	1.34
3500	.681	.742	.874	.934	1.00	1.12	1.26	1.38	1.50	1.75	1.88

Belt life will be reduced for ratings to the left of the heavy line.

Center Distance

To calculate the approximate Belt Length:

$$BL = 2C + \frac{D_1 - D_2}{4C} + 1.57 (D_1 + D_2)$$

An approximate formula for center distance of a timing belt drive is:

$$C = \frac{P}{4} \left[NB - \frac{N_1 + N_2}{2} \right] + \sqrt{\left(NB - \frac{N_1 + N_2}{2} \right)^2 - 2 \left(\frac{N_1 - N_2}{\pi} \right)^2}$$

$$BL = 2C + \frac{(D_1 - D_2)}{4C} + 1.57 (D_1 + D_2)$$

Where:

C = Center Distance—Inches

P = Belt Pitch—Inches

NB = Number of Teeth in Belt

N₁ = Number of Grooves in larger Pulley

N₂ = Number of Grooves in smaller Pulley

BL = Belt Length

D₁ = Pitch Diameter of larger Pulley

D₂ = Pitch Diameter of smaller Pulley

Installation Suggestions

1. Use care in handling belts to avoid breakage of the reinforcing fibers.
2. Make sure shafts are parallel and pulleys in alignment.
3. Belt should fit snugly, neither too loose nor too tight. Avoid preload, which can cause premature failure.
4. Provision for some Center Distance adjustment will ease the installation and permit proper initial fitting of belts.

Miniature HTD® Timing Belts

3M Series 6 and 9mm Widths

3mm Pitch

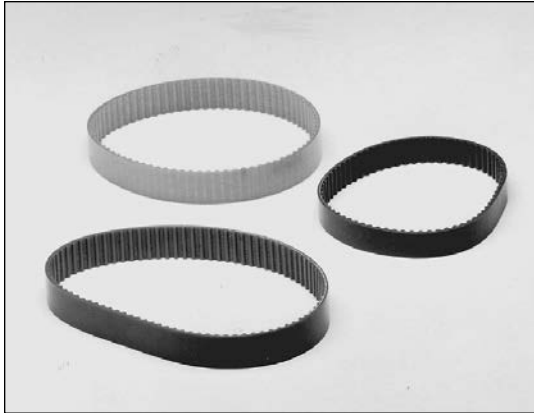

NEOPRENE-NYLON COVERED, FIBERGLASS REINFORCED
AMBIENT TEMPERATURE RANGE— -18°C TO +85°C
BREAKING STRENGTH—6 mm WIDTH – 74.4 KGS
9 mm WIDTH – 111.6 KGS

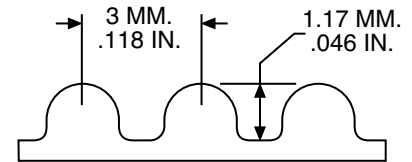
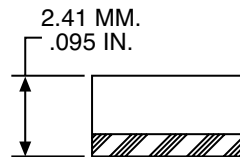

ORDER BY CATALOG NUMBER OR ITEM CODE

Number of Grooves	Pitch Length		6mm Belt Width		9mm Belt Width	
	mm	Inch	Catalog Number	Item Code	Catalog Number	Item Code
35	105	4.134	3M035060	54214	3M035090	54290
37	111	4.370	3M037060	54215	3M037090	54291
48	144	5.669	3M048060	54216	3M048090	54292
49	147	5.787	3M049060	54217	3M049090	54293
50	150	5.905	3M050060	54218	3M050090	54294
52	156	6.142	3M052060	54219	3M052090	54295
53	159	6.260	3M053060	54220	3M053090	54296
56	168	6.614	3M056060	54221	3M056090	54297
59	177	6.968	3M059060	54222	3M059090	54298
60	180	7.087	3M060060	54223	3M060090	54299
65	195	7.677	3M065060	54224	3M065090	54300
67	201	7.913	3M067060	54225	3M067090	54301
68	204	8.031	3M068060	54226	3M068090	54302
69	207	8.150	3M069060	54227	3M069090	54303
70	210	8.268	3M070060	54228	3M070090	54304
71	213	8.386	3M071060	54229	3M071090	54305
75	225	8.858	3M075060	54230	3M075090	54306
78	234	9.213	3M078060	54231	3M078090	54307
80	240	9.449	3M080060	54232	3M080090	54308
84	252	9.921	3M084060	54233	3M084090	54309
85	255	10.039	3M085060	54234	3M085090	54310
89	267	10.512	3M089060	54236	3M089090	54312
90	270	10.630	3M090060	54237	3M090090	54313
92	276	10.866	3M092060	54238	3M092090	54314
94	282	11.102	3M094060	54239	3M094090	54315
95	285	11.220	3M095060	54240	3M095090	54316
96	288	11.339	3M096060	54241	3M096090	54317
97	291	11.457	3M097060	54242	3M097090	54318
99	297	11.693	3M099060	54243	3M099090	54319
100	300	11.811	3M100060	54244	3M100090	54320
104	312	12.283	3M104060	54245	3M104090	54321
106	318	12.520	3M106060	54246	3M106090	54322
111	333	13.110	3M111060	54247	3M111090	54323
112	336	13.228	3M112060	54248	3M112090	54324
113	339	13.346	3M113060	54249	3M113090	54325
115	345	13.583	3M115060	54250	3M115090	54326
119	357	14.055	3M119060	54251	3M119090	54327

Number of Grooves	Pitch Length		6mm Belt Width		9mm Belt Width	
	mm	Inch	Catalog Number	Item Code	Catalog Number	Item Code
121	363	14.291	3M121060	54252	3M121090	54328
128	384	15.118	3M128060	54253	3M128090	54329
130	390	15.354	3M130060	54254	3M130090	54330
132	396	15.591	3M132060	54255	3M132090	54331
140	420	16.535	3M140060	54256	3M140090	54332
145	435	17.126	3M145060	54257	3M145090	54333
149	447	17.598	3M149060	54258	3M149090	54334
153	459	18.071	3M153060	54259	3M153090	54335
155	465	18.307	3M155060	54260	3M155090	54336
158	474	18.661	3M158060	54261	3M158090	54337
160	480	18.898	3M160060	54262	3M160090	54338
162	486	19.134	3M162060	54263	3M162090	54339
163	489	19.252	3M163060	54264	3M163090	54340
167	501	19.724	3M167060	54265	3M167090	54341
171	513	20.197	3M171060	54266	3M171090	54342
175	525	20.670	3M175060	54267	3M175090	54343
177	531	20.905	3M177060	54268	3M177090	54344
179	537	21.142	3M179060	54269	3M179090	54345
188	564	22.205	3M188060	54270	3M188090	54346
192	576	22.677	3M192060	54271	3M192090	54347
199	597	23.504	3M199060	54272	3M199090	54348
200	600	23.622	3M200060	54273	3M200090	54349
204	612	24.094	3M204060	54274	3M204090	54350
211	633	24.921	3M211060	54275	3M211090	54351
223	669	26.338	3M223060	54276	3M223090	54352
237	711	27.992	3M237060	54277	3M237090	54353
250	750	29.527	3M250060	54278	3M250090	54354
251	753	29.646	3M251060	54279	3M251090	54355
294	892	34.724	3M294060	54280	3M294090	54356
315	945	37.205	3M315060	54281	3M315090	54357
354	1062	41.811	3M354060	54282	3M354090	54358
375	1125	44.291	3M375060	54283	3M375090	54360
415	1245	49.016	3M415060	54284	3M415090	54361
421	1263	49.724	3M421060	54285	3M421090	54362
500	1500	59.055	3M500060	54286	3M500090	54363
510	1530	60.235	3M510060	54287	3M510090	54364
621	1863	73.346	3M621060	54288	3M621090	54365

*Registered trademark of UNIROYAL, INC.

Timing Belt Pulleys

PA Series For 6mm Wide Belts 3mm Pitch; Aluminum

ALUMINUM ALLOY – CLEAR ANODIZED
COMPLETE WITH SETSCREWS



**WITH FLANGES
10 TO 17 GROOVES**

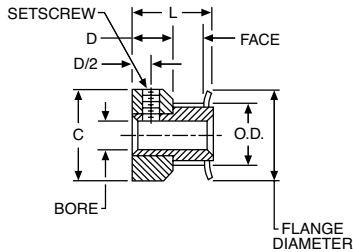

**WITH FLANGES
18 TO 44 GROOVES**

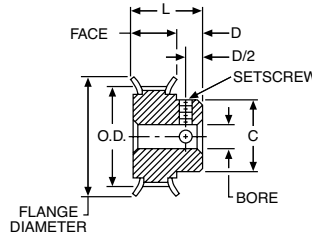

WITHOUT FLANGES

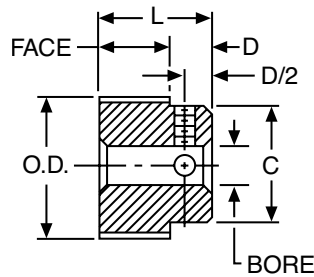

STANDARD TOLERANCES

DIMENSIONS		TOLERANCE
Bore	All	+0.001 to -0.000
	10-26 Grooves	+0.002 to -0.000
O.D.	28-48 Grooves	+0.003 to -0.000
	60-72 Grooves	+0.004 to -0.000

ORDER BY CATALOG NUMBER OR ITEM CODE

Number of Grooves	Pitch Dia.	O.D.	B	Face Width	C	D	L	Flange Dia.	Setscrew*	With Flanges		Without Flanges	
										Catalog Number	Item Code	Catalog Number	Item Code
10	.376	.346	.125	.282	.505	15/64	9/16	.505	#4-40	PA3010DF060	54448	-	-
11	.414	.384			.530			.530		PA3011DF060	54449	-	-
12	.451	.421	.1875	.282	.580	15/64	9/16	.580	#6-40	PA3012DF060	54450	-	-
13	.489	.459			.610			.610		PA3013DF060	54451	-	-
14	.526	.496			.635			.635		PA3014DF060	54452	-	-
15	.564	.534			.685			.685		PA3015DF060	54453	-	-
16	.602	.572			.710			.710		PA3016DF060	54454	-	-
17	.639	.609			.740			.740		PA3017DF060	54455	-	-
18	.677	.647			.250			.386		.442	19/64	11/16	.790
19	.714	.684	.468	.815		PA3019DF060	54457		PA3019NF060	54472			
20	.752	.722	.500	.895		PA3020DF060	54458		PA3020NF060	54473			
22	.827	.797	.562	.945		PA3022DF060	54459		PA3022NF060	54474			
24	.902	.872	.625	1.025		PA3024DF060	54460		PA3024NF060	54475			
25	.940	.910	.625	1.060		PA3025DF060	54461		PA3025NF060	54476			
26	.977	.947	.625	1.105		PA3026DF060	54462		PA3026NF060	54477			
28	1.053	1.023	.701	1.173		PA3028DF060	54463		PA3028NF060	54478			
30	1.128	1.098	.776	1.250		PA3030DF060	54464		PA3030NF060	54479			
32	1.203	1.173	.851	1.323		PA3032DF060	54465		PA3032NF060	54480			
34	1.278	1.248	.921	1.398		PA3034DF060	54466		PA3034NF060	54481			
36	1.353	1.323	1.000	1.473		PA3036DF060	54467		PA3036NF060	54482			
38	1.429	1.399	1.075	1.549		PA3038DF060	54468		PA3038NF060	54483			
40	1.504	1.474	1.150	1.625		PA3040DF060	54469		PA3040NF060	54484			
44	1.654	1.624	1.300	1.775	PA3044DF060	54470	PA3044NF060	54485					
48	1.805	1.775	.3125	.407	-	21/64	47/64	-		-	-	PA3048NF060	54486
50	1.880	1.850			-			-		-	-	PA3050NF060	54487
56	2.105	2.075			-			-		-	-	PA3056NF060	54488
60	2.256	2.226			-			-		-	-	PA3060NF060	54489
62	2.331	2.301			-			-		-	-	PA3062NF060	54490
72	2.707	2.677			-			-		-	-	PA3072NF060	54991

*Pulleys with 10 to 13 grooves have one setscrew. All others have two at 90°

Timing Belt Pulleys

PA Series For 9mm Wide Belts

3mm Pitch; Aluminum



ALUMINUM ALLOY - CLEAR ANODIZED
COMPLETE WITH SETSCREWS

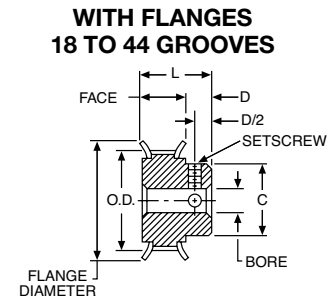
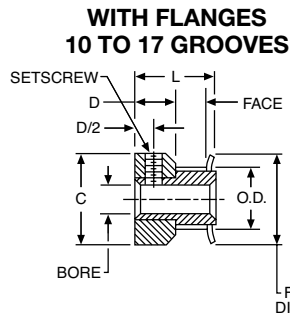

WITHOUT FLANGES

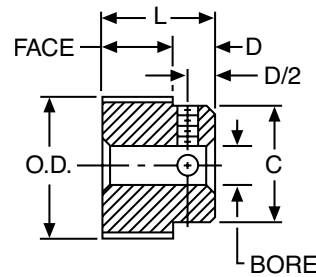

STANDARD TOLERANCES

DIMENSIONS		TOLERANCE
Bore	All	+0.001 to -0.000
	10-26 Grooves	+0.002 to -0.000
O.D.	28-48 Grooves	+0.003 to -0.000
	60-72 Grooves	+0.004 to -0.000

ORDER BY CATALOG NUMBER OR ITEM CODE

Number of Grooves	Pitch Dia.	O.D.	B	Face Width	C	D	L	Flange Dia.	Setscrew*	With Flanges		Without Flanges				
										Catalog Number	Item Code	Catalog Number	Item Code			
10	.376	.346	.125	.401	.505	15/64	11/16	.505	#4-40	PA3010DF090	54492	-	-			
11	.414	.384			.530			.530		PA3011DF090	54493	-	-			
12	.451	.421	.1875	.506	.580	19/64	13/16	.580	#6-40	PA3012DF090	54494	-	-			
13	.489	.459			.610			.610		PA3013DF090	54495	-	-			
14	.526	.496			.635			.635		PA3014DF090	54496	-	-			
15	.564	.534			.685			.685		PA3015DF090	54497	-	-			
16	.602	.572			.710			.710		PA3016DF090	54498	-	-			
17	.639	.609			.740			.740		PA3017DF090	54499	-	-			
18	.677	.647			.250			.527		.442	27/32	1.025	.790	#8-32	PA3018DF090	54500
19	.714	.684	.468	.815		PA3019DF090	54501		PA3019NF090	54516						
20	.752	.722	.500	.895		PA3020DF090	54502		PA3020NF090	54517						
22	.827	.797	.562	.945		PA3022DF090	54503		PA3022NF090	54518						
24	.902	.872	.625	1.060		PA3024DF090	54504		PA3024NF090	54519						
25	.940	.910	.625	1.105		PA3025DF090	54505		PA3025NF090	54520						
26	.977	.947	.625	1.173		PA3026DF090	54506		PA3026NF090	54521						
28	1.053	1.023	.701	1.173		PA3028DF090	54507		PA3028NF090	54522						
30	1.128	1.098	.776	1.250		PA3030DF090	54508		PA3030NF090	54523						
32	1.203	1.173	.851	1.323		PA3032DF090	54509		PA3032NF090	54524						
34	1.278	1.248	.921	1.398		PA3034DF090	54510		PA3034NF090	54525						
36	1.353	1.323	1.000	1.473		PA3036DF090	54511		PA3036NF090	54526						
38	1.429	1.399	1.075	1.549		PA3038DF090	54512		PA3038NF090	54527						
40	1.504	1.474	1.150	1.625		PA3040DF090	54513		PA3040NF090	54528						
44	1.654	1.624	1.300	1.775	PA3044DF090	54514	PA3044NF090	54529								
48	1.805	1.775	.3125	.500	-	3/8	7/8	-	-	-	-	PA3048NF090	54530			
50	1.880	1.850			-			-	-	-	-	-	PA3050NF090	54531	-	-
56	2.105	2.075			-			-	-	-	-	-	PA3056NF090	54532	-	-
60	2.256	2.226			-			-	-	-	-	-	PA3060NF090	54533	-	-
62	2.331	2.301			-			-	-	-	-	-	PA3062NF090	54534	-	-
72	2.707	2.677			-			-	-	-	-	-	-	-	PA3072NF090	54535

*Pulleys with 10 to 13 grooves have one setscrew. All others have two at 90°

Timing Belt Pulleys

PL Series For 9mm Wide Belts

3mm Pitch; Lexan

LEXAN – FIBERGLASS REINFORCED

**SINGLE FLANGE
10-28 GROOVES**

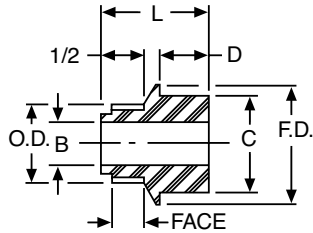

**SINGLE FLANGE
32-120 GROOVES**

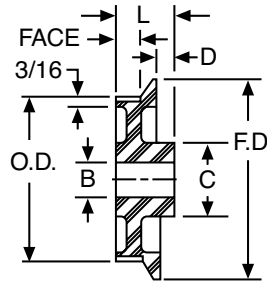

**DOUBLE FLANGE
10-28 GROOVES**

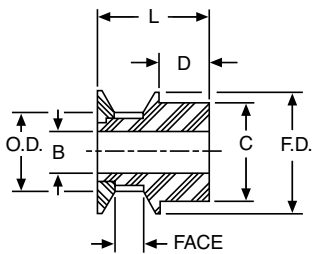

**DOUBLE FLANGE
32-80 GROOVES**

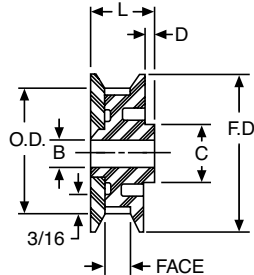

STANDARD TOLERANCES

DIMENSIONS		TOLERANCE
Bore	All	+0.001 to -0.000

ORDER BY CATALOG NUMBER OR ITEM CODE

Number of Grooves	Pitch Dia.	O.D.	B	Face Width	C	D	L	Flange Dia.	Single Flange		Double Flange	
									Catalog Number	Item Code	Catalog Number	Item Code
10	.376	.346	3/16	7/16	5/8	1/4	3/4*	.63	PL3010SF090	54536	PL3010DF090	54560
11	.414	.384							PL3011SF090	54537	PL3011DF090	54561
12	.451	.421							PL3012SF090	54538	PL3012DF090	54562
13	.489	.459							PL3013SF090	54539	PL3013DF090	54563
14	.526	.496							PL3014SF090	54540	PL3014DF090	54564
15	.564	.534			PL3015SF090		54541	PL3015DF090	54565			
16	.602	.572			PL3016SF090		54542	PL3016DF090	54566			
17	.639	.609			PL3017SF090		54543	PL3017DF090	54567			
18	.677	.647			PL3018SF090		54544	PL3018DF090	54568			
19	.714	.684			PL3019SF090		54545	PL3019DF090	54569			
20	.752	.722	PL3020SF090	54546	PL3020DF090	54570						
22	.827	.797	1/4	3/4	7/8	13/16	13/16	1.06	PL3022SF090	54547	PL3022DF090	54571
25	.940	.910						1.19	PL3025SF090	54548	PL3025DF090	54572
28	1.053	1.023						1.24	PL3028SF090	54549	PL3028DF090	54573
32	1.203	1.173						1.44	PL3032SF090	54550	PL3032DF090	54574
36	1.353	1.323						1.57	PL3036SF090	54551	PL3036DF090	54575
40	1.504	1.474						1.76	PL3040SF090	54552	PL3040DF090	54576
48	1.805	1.775						2.02	PL3048SF090	54553	PL3048DF090	54577
60	2.256	2.226						2.46	PL3060SF090	54554	PL3060DF090	54578
72	2.707	2.677						2.92	PL3072SF090	54555	PL3072DF090	54579
80	3.008	2.978						3.29	PL3080SF090	54556	PL3080DF090	54580
84	3.158	3.128	13/16	1	3/8	7/8	3.38	PL3084SF090	54557	-	-	
96	3.609	3.579					3.83	PL3096SF090	54558	-	-	
120	4.511	4.481					-	PL3120NF090†	54559	-	-	

*13/16" for Double Flanges

**7/8" for Double Flanges

†No Flange

E

Timing Belt Pulleys

PLB Series For 9mm Wide Belts

3mm Pitch; Lexan



**LEXAN – FIBERGLASS REINFORCED
KNURLED ALUMINUM INSERTS
COMPLETE WITH SETSCREWS**

**SINGLE FLANGE
10-16 GROOVES**

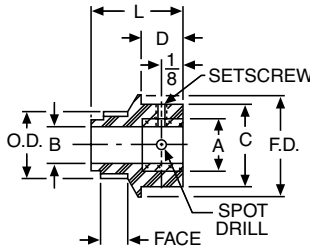

**SINGLE FLANGE
17-28 GROOVES**

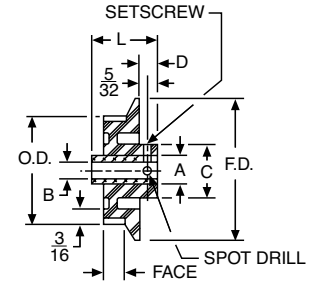

**DOUBLE FLANGE
10-16 GROOVES**

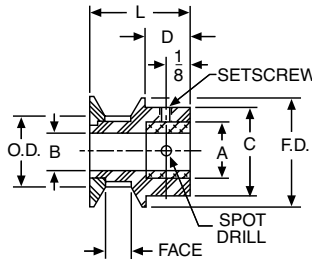

**DOUBLE FLANGE
17-28 GROOVES**

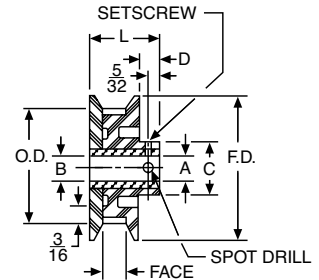

STANDARD TOLERANCES

DIMENSIONS		TOLERANCE
Bore	All	+.001 to -.000

ORDER BY CATALOG NUMBER OR ITEM CODE

Number of Grooves	Pitch Dia.	O.D.	B	Face Width	C	D	Insert Dia.	L	Flange Dia.	Set-screw	Single Flange		Double Flanges	
											Catalog Number	Item Code	Catalog Number	Item Code
10	.376	.346	3/16	7/16	5/8	1/4	3/8	3/4	.63	#6-32	PLB3010SF090	54581	PLB3010DF090	54633
11	.414	.384									PLB3011SF090	54582	PLB3011DF090	54634
12	.451	.421									PLB3012SF090	54583	PLB3012DF090	54635
13	.489	.459									PLB3013SF090	54584	PLB3013DF090	54636
14	.526	.496									PLB3014SF090	54585	PLB3014DF090	54637
15	.564	.534									PLB3015SF090	54586	PLB3015DF090	54638
16	.602	.572									PLB3016SF090	54587	PLB3016DF090	54639
17	.639	.609	3/16 1/4	7/16	11/16	1/4	3/8	13/16	.69	#6-32	PLB3017SF09-3/16	54588	PLB3017DF09-3/16	54640
18	.677	.647	3/16 1/4								PLB3017SF09-1/4	54589	PLB3017DF09-1/4	54641
											PLB3018SF09-3/16	54590	PLB3018DF09-3/16	54642
19	.714	.684	3/16								PLB3018SF09-1/4	54591	PLB3018DF09-1/4	54643
											PLB3019SF09-3/16	54592	PLB3019DF09-3/16	54644
20	.752	.722	3/16 1/4								PLB3019SF-09-1/4	54593	PLB3019DF09-1/4	54645
											PLB3020SF09-3/16	54594	PLB3020DF09-3/16	54646
22	.827	.797	3/16	PLB3020SF09-1/4	54595	PLB3020DF09-1/4	54647							
				PLB3022SF09-3/16	54596	PLB3022DF09-3/16	54649							
25	.940	.910	1/4 5/16 3/8	3/4	1/2	1/2	1/2	1.06	1.19	#8-32	PLB3025SF09-1/4	54598	PLB3025DF09-1/4	54650
											PLB3025SF09-5/16	54599	PLB3025DF09-5/16	54651
											PLB3025SF09-3/8	54600	PLB3025DF09-3/8	54652
28	1.053	1.023	1/4 5/16 3/8	3/4	1/2	1/2	1/2	1.19	1.24	#8-32	PLB3028SF09-1/4	54601	PLB3028DF09-1/4	54653
											PLB3028SF09-5/16	54602	PLB3028DF09-5/16	54654
											PLB3028SF09-3/8	54603	PLB3028DF09-3/8	54655

E

Timing Belt Pulleys

PLB Series For 9mm Wide Belts

3mm Pitch; Lexan

LEXAN – FIBERGLASS REINFORCED
KNURLED ALUMINUM INSERTS
COMPLETE WITH SETSCREWS

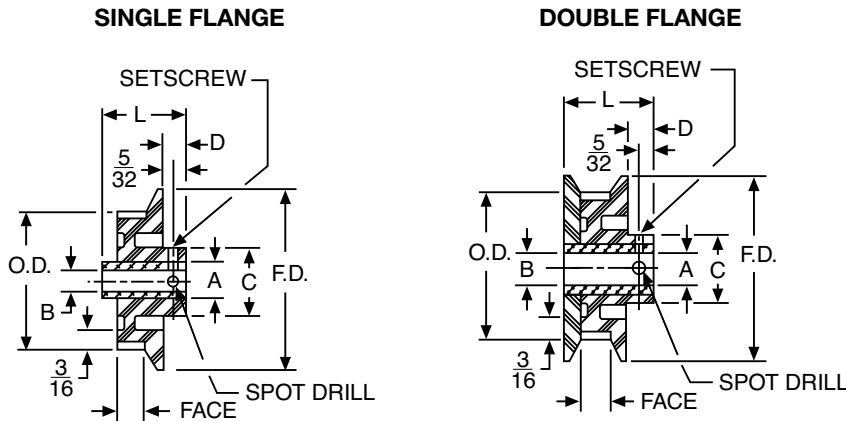

STANDARD TOLERANCES

Dimension	Tolerance
Bore	All
	+0.001 to -0.000

ORDER BY CATALOG NUMBER OR ITEM CODE

Number of Grooves	Pitch Dia.	O.D.	B	Face Width	C	D	Insert Dia.	L	Flange Dia.	Set-screw	Single Flange		Double Flanges	
											Catalog Number	Item Code	Catalog Number	Item Code
32	1.203	1.173	1/4	7/16	3/4	1/4	1/2	13/16	1.44	#8-32	PLB3032SF09-1/4	54604	PLB3032DF09-1/4	54656
			5/16						PLB3032SF09-5/16		54605	PLB3032DF09-5/16	54657	
			3/8						PLB3032SF09-3/8		54606	PLB3032DF09-3/8	54658	
36	1.353	1.323	1/4	7/16	7/8	1/4	1/2	13/16	1.57	#8-32	PLB3036SF09-1/4	54607	PLB3036DF09-1/4	54659
			5/16						PLB3036SF09-5/16		54608	PLB3036DF09-5/16	54660	
			3/8						PLB3036SF09-3/8		54609	PLB3036DF09-3/8	54661	
40	1.504	1.474	1/4	7/16	7/8	1/4	1/2	13/16	1.76	#8-32	PLB3040SF09-1/4	54610	PLB3040DF09-1/4	54662
			5/16						PLB3040SF09-5/16		54611	PLB3040DF09-5/16	54663	
			3/8						PLB3040SF09-3/8		54612	PLB3040DF09-3/8	54664	
48	1.805	1.775	1/4	7/16	7/8	1/4	1/2	13/16	2.02	#8-32	PLB3048SF09-1/4	54613	PLB3048DF09-1/4	54665
			5/16						PLB3048SF09-5/16		54614	PLB3048DF09-5/16	54666	
			3/8						PLB3048SF09-3/8		54615	PLB3048DF09-3/8	54667	
60	2.256	2.226	5/16	7/16	7/8	1/4	1/2	13/16	2.46	#8-32	PLB3060SF09-5/16	54616	PLB3060DF09-5/16	54668
			3/8						PLB3060SF09-3/8		54617	PLB3060DF09-3/8	54669	
			1/2						PLB3060SF09-1/2		54618	PLB3060DF09-1/2	54670	
72	2.707	2.677	5/16	7/16	7/8	1/4	1/2	13/16	2.92	#8-32	PLB3072SF09-5/16	54619	PLB3072DF09-5/16	54671
			3/8						PLB3072SF09-3/16		54620	PLB3072DF09-3/8	54672	
			1/2						PLB3072SF09-1/2		54621	PLB3072DF09-1/2	54673	
80	3.008	2.978	5/16	7/16	7/8	1/4	1/2	13/16	3.29	#10-32	PLB3080SF09-5/16	54622	PLB3080DF09-5/16	54674
			3/8						PLB3080SF09-3/8		54623	PLB3020DF09-3/8	54675	
			1/2						PLB3080SF09-1/2		54624	PLB3080DF09-1/2	54676	
84	3.158	3.128	5/16	7/16	7/8	1/4	1/2	13/16	3.38	#10-32	PLB3084SF09-5/16	54625	-	-
			3/8						PLB3084SF09-3/8		54626	-	-	
			1/2						PLB3084SF09-1/2		54627	-	-	
96	3.609	3.579	5/16	7/16	7/8	1/4	1/2	13/16	3.83	#10-32	PLB3096SF09-5/16	54628	-	-
			3/8						PLB3096SF09-3/8		54629	-	-	
			1/2						PLB3096SF09-1/2		54630	-	-	
120	4.511	4.481	3/8	1/2	3/8	1/4	1/2	7/8	-	#10-32	PLB3120NF09-3/8*	54631	-	-
			1/2						PLB3120NF09-1/2*		54632	-	-	

†7/8" for Double Flange
*No Flange

E

Miniature HTD® Timing Belts

5M Series 9 and 15mm Widths

5mm Pitch

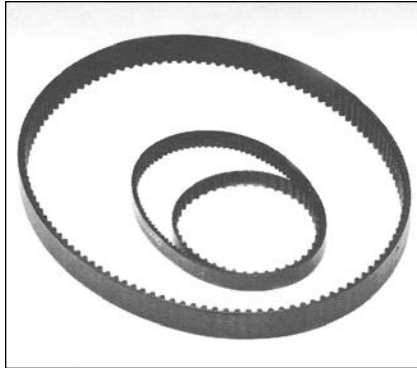

NEOPRENE-NYLON COVERED, FIBERGLASS REINFORCED
AMBIENT TEMPERATURE RANGE— -18°C TO +85°C
BREAKING STRENGTH—6 mm WIDTH – 234 KGS
9 mm WIDTH – 390 KGS

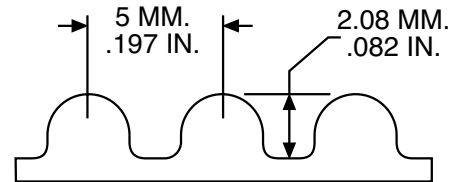
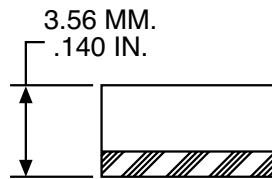

ORDER BY CATALOG NUMBER OR ITEM CODE

Number of Grooves	Pitch Length		9mm Belt Width		15mm Belt Width	
	mm	Inch	Catalog Number	Item Code	Catalog Number	Item Code
64	320	12.598	–	–	5M064150	54407
66	330	12.992	5M066090	54367	5M066150	54408
70	350	13.779	5M070090	54368	5M070150	54409
75	375	14.764	5M075090	54369	5M075150	54410
80	400	15.748	5M080090	54370	5M080150	54411
85	425	16.732	5M085090	54371	5M085150	54412
90	450	17.716	5M090090	54372	5M090150	54413
95	475	18.700	5M095090	54373	5M095150	54414
100	500	19.685	5M100090	54374	5M100150	54415
107	535	21.063	5M107090	54376	5M107150	54417
113	565	22.244	5M113090	54377	5M113150	54418
120	600	23.622	5M120090	54378	5M120150	54419
123	615	24.213	5M123090	54379	5M123150	54420
127	635	25.000	5M127090	54380	5M127150	54421
133	665	26.181	5M133090	54381	5M133150	54422
134	670	26.378	5M134090	54382	5M134150	54423
142	710	27.953	5M142090	54383	5M142150	54424
148	740	29.134	5M148090	54384	5M148150	54425
151	755	29.724	5M151090	54385	5M151150	54426
160	800	31.596	5M160090	54386	5M160150	54427
166	830	32.677	5M166090	54387	5M166150	54428
167	835	32.874	5M167090	54388	5M167150	54429
170	850	33.464	5M170090	54389	5M170150	54430
178	890	35.039	5M178090	54390	5M178150	54431
185	925	36.417	5M185090	54391	5M185150	54432
186	930	36.614	5M186090	54392	5M186150	54433
190	950	37.401	5M190090	54393	5M190150	54434
200	1000	39.370	5M200090	54394	5M200150	54435
210	1050	41.339	5M210090	54395	5M210150	54436
225	1125	44.291	5M225090	54396	5M225150	54437
254	1270	50.000	5M254090	54397	5M254150	54438
284	1420	55.905	5M284090	54398	5M284150	54439
319	1595	62.795	5M319090	54399	5M319150	54440
358	1790	70.472	5M358090	54400	5M358150	54441
360	1800	70.866	5M360090	54401	5M360150	54442
374	1870	73.622	5M374090	54402	5M374150	54443
379	1895	74.606	5M379090	54403	5M379150	54444
389	1945	76.575	5M389090	54404	5M389150	54445
400	2000	78.740	5M400090	54405	5M400150	54446
505	2525	99.409	5M505090	54406	5M505150	54447

®Registered trademark of UNIROYAL, INC.

Timing Belt Pulleys

PA Series For 9mm Wide Belts 5mm Pitch; Aluminum

ALUMINUM ALLOY – CLEAR ANODIZED
COMPLETE WITH SETSCREWS

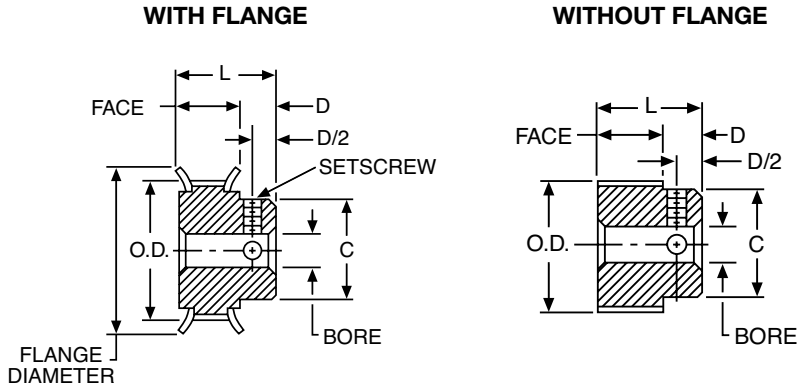

STANDARD TOLERANCES

Dimension		Tolerance
Bore	All	+0.001 to -0.000
O.D.	12-16 Grooves	+0.002 to -0.000
	17-32 Grooves	+0.003 to -0.000
	34-62 Grooves	+0.004 to -0.000
	72 Grooves	+0.005 to -0.000

ORDER BY CATALOG NUMBER OR ITEM CODE

Number of Grooves	Pitch Dia.	O.D.	B	Face Width	C	D	L	Flange Dia.	Setscrew*	With Flanges		Without Flanges	
										Catalog Number	Item Code	Catalog Number	Item Code
12	.752	.707	.250	35/64	7/16	1/4	51/64	7/8	#8-32	PA5012DF090	54677	PA5012NF090	54694
13	.815	.770			1/2			15/16					
14	.877	.832			1/2			1					
15	.940	.895			9/16			1-1/16					
16	1.003	.958			9/16			1-3/32					
17	1.065	1.020			5/8			1-3/16					
18	1.128	1.083			11/16			1-1/4					
19	1.191	1.146			3/4			1-5/16					
20	1.253	1.208			13/16			1-3/8					
22	1.379	1.334			15/16			1-1/2					
24	1.504	1.459			1			1-5/8					
25	1.566	1.521			1			1-11/16					
26	1.629	1.584			1-1/16	1-3/4							
28	1.754	1.709			1-3/16	1-7/8							
30	1.880	1.835			1-3/16	2							
32	2.005	1.960			1-1/4	2-1/8							
34	2.130	2.085			1-3/8	2-1/4							
36	2.256	2.211			.3125	1-1/2	25/64	15/16	-	#10-32	-	-	PA5036NF090
38	2.381	2.336	-	-					PA5038NF090		54712		
40	2.506	2.461	-	-					PA5040NF090		54713		
44	2.757	2.712	-	-					PA5044NF090		54714		
48	3.008	2.963	-	-					PA5048NF090		54715		
50	3.133	3.088	-	-					PA5050NF090		54716		
56	3.509	3.464	.375	1-1/2	25/64	15/16	-	#10-32	-	-	PA5056NF090	54717	
60	3.760	3.715					-		-	PA5060NF090	54718		
62	3.885	3.840					-		-	PA5062NF090	54719		
72	4.511	4.466					-		-	PA5072NF090	54720		

*Pulleys with 12 and 13 grooves have one setscrew. All others have two at 90°

E

Timing Belt Pulleys

PA Series For 15mm Wide Belts

5mm Pitch; Aluminum



ALUMINUM ALLOY – CLEAR ANODIZED†
COMPLETE WITH SETSCREWS

WITH FLANGE

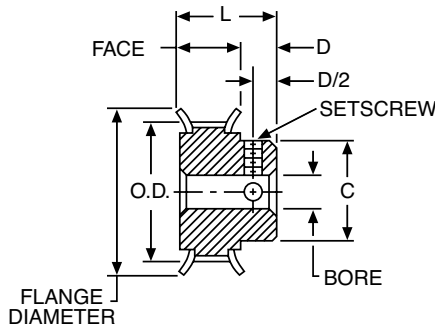

WITHOUT FLANGE

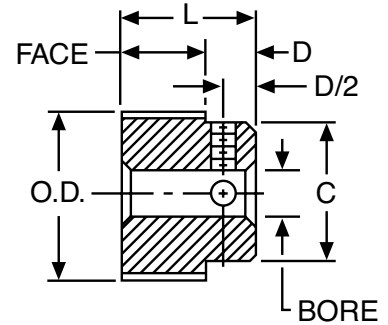

STANDARD TOLERANCES

DIMENSIONS		TOLERANCE
Bore	All	+0.001 to -0.000
O.D.	12-16 Grooves	+0.002 to -0.000
	17-32 Grooves	+0.003 to -0.000
	34-62 Grooves	+0.004 to -0.000
	72 Grooves	+0.005 to -0.000

ORDER BY CATALOG NUMBER OR ITEM CODE

Number of Grooves	Pitch Dia.	O.D.	B	Face Width	C	D	L	Flange Dia.	Setscrew*	With Flanges		Without Flanges			
										Catalog Number	Item Code	Catalog Number	Item Code		
12	.752	.707	.250		7/16	1/4	1-1/32	7/8	#8-32	PA5012DF150	54721	PA5012NF150	54738		
13	.815	.770			1/2			15/16		PA5013DF150	54722	PA5013NF150	54739		
14	.877	.832			1/2			1		PA5014DF150	54723	PA5014NF150	54740		
15	.940	.895			9/16			1-1/16		PA5015DF150	54724	PA5015NF150	54741		
16	1.003	.958			9/16			1-3/32		PA5016DF150	54725	PA5016NF150	54742		
17	1.065	1.020			5/8			1-3/16		PA5017DF150	54726	PA5017NF150	54743		
18	1.128	1.083			11/16			1-1/4		PA5018DF150	54727	PA5018NF150	54744		
19	1.191	1.146			3/4			1-5/16		PA5019DF150	54728	PA5019NF150	54745		
20	1.253	1.208			13/16			1-3/8		PA5020DF150	54729	PA5020NF150	54746		
22	1.379	1.334			15/16			1-1/2		PA5022DF150	54730	PA5022NF150	54747		
24	1.504	1.459			1			1-5/8		PA5024DF150	54731	PA5024NF150	54748		
25	1.566	1.521			1			1-11/16		PA5025DF150	54732	PA5025NF150	54749		
26	1.629	1.584			25/32	1-3/4	PA5026DF150	54733		PA5026NF150	54750				
28	1.754	1.709				1-3/16	5/16	1-3/32		1-7/8	PA5028DF150	54734	PA5028NF150	54751	
30	1.880	1.835				1-3/16	2	PA5030DF150		54735	PA5030NF150	54752			
32	2.005	1.960				1-1/4	2-1/8	PA5032DF150		54736	PA5032NF150	54753			
34	2.130	2.085				1-3/8	2-1/4	PA5034DF150		54737	PA5034NF150	54754			
36	2.256	2.211				.3125	-	-		-	-	-	PA5036NF150	54755	
38	2.381	2.336			-		-	-		-	-	-	PA5038NF150	54756	
40	2.506	2.461			-		-	-		-	-	-	PA5040NF150	54757	
44	2.757	2.712			-		-	-		-	-	-	PA5044NF150	54758	
48	3.008	2.963			.375		1-1/2	13/32		1-3/16	-	-	PA5048NF150	54759	
50	3.133	3.088					-	-		-	-	-	-	PA5050NF150	54760
56	3.509	3.464					-	-		-	-	-	-	PA5056NF150	54761
60	3.760	3.715	-	-			-	-	-	-	PA5060NF150	54762			
62	3.885	3.840	.375	-	-	-	-	-	PA5062NF150	54763					
72	4.511	4.466		-	-	-	-	-	-	PA5072NF150	54764				

*Pulleys with 12 and 13 grooves have one setscrew. All others have two at 90°

†44-72 grooves, material is A356-T6 (cast).

Timing Belt Pulleys

PL Series For 9mm Wide Belts

5mm Pitch; Lexan

LEXAN – FIBERGLASS REINFORCED

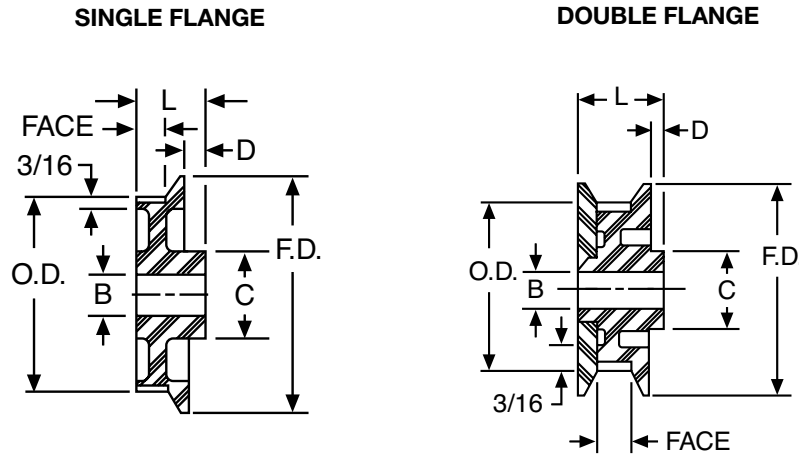

STANDARD TOLERANCES

Dimension		Tolerances
Bore	All	+0.001 to -0.000

ORDER BY CATALOG NUMBER OR ITEM CODE

Number of Grooves	Pitch Dia.	O.D.	B	Face Width	C	D	L	Flange Dia.	Single Flange		Double Flange	
									Catalog Number	Item Code	Catalog Number	Item Code
11	.689	.644	3/16	7/16	11/16	3/4*	13/16	.87	PL5011SF090	54765	PL5011DF090	54782
12	.752	.707						.93	PL5012SF090	54766	PL5012DF090	54783
13	.815	.770						.99	PL5013SF090	54767	PL5013DF090	54784
14	.877	.832	1.06		PL5014SF090	54768		PL5014DF090	54785			
15	.940	.895	1.19		PL5015SF090	54769		PL5015DF090	54786			
16	1.003	.958	1.19		PL5016SF090	54770		PL5016DF090	54787			
17	1.065	1.020	1/4	3/4	1/4		1.24	PL5017SF090	54771	PL5017DF090	54788	
18	1.128	1.083					1.31	PL5018SF090	54772	PL5018DF090	54789	
19	1.191	1.146					1.38	PL5019SF090	54773	PL5019DF090	54790	
20	1.253	1.208	7/8				1.44	PL5020SF090	54774	PL5020DF090	54791	
22	1.379	1.334					1.57	PL5022SF090	54775	PL5022DF090	54792	
25	1.566	1.521					1.76	PL5025SF090	54776	PL5025DF090	54793	
28	1.754	1.709					1.95	PL5028SF090	54777	PL5028DF090	54794	
29	1.817	1.772					2.02	PL5029SF090	54778	PL5029DF090	54795	
30	1.880	1.835					2.08	PL5030SF090	54779	PL5030DF090	54796	
40	2.506	2.461	5/16		5/16	13/16*	2.71	PL5040SF090	54780	PL5040DF090	54797	
50	3.133	3.088					3.29	PL5050SF090	54781	PL5050DF090	54798	

*7/8" for Double Flange.

E

Timing Belt Pulleys

PLB Series For 9mm Wide Belts

5mm Pitch; Lexan

LEXAN – FIBERGLASS REINFORCED
KNURLED ALUMINUM INSERTS
COMPLETE WITH SETSCREWS

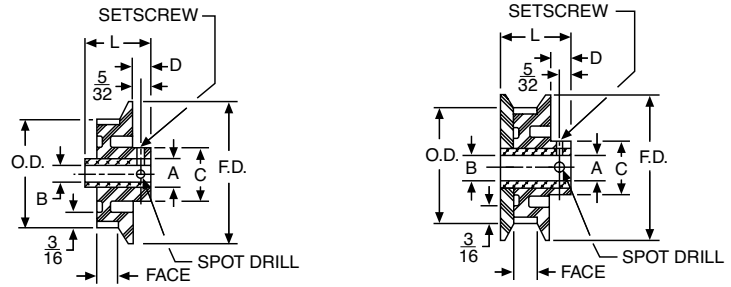

STANDARD TOLERANCES

DIMENSIONS		TOLERANCE
Bore	All	+0.001 to -0.000

ORDER BY CATALOG NUMBER OR ITEM CODE

Number of Grooves	Pitch Dia.	O.D.	B	Face Width	C	D	Insert Dia.	L	Flange Dia.	Set-screw*	Single Flange		Double Flanges	
											Catalog Number	Item Code	Catalog Number	Item Code
11	.689	.644	3/16 1/4	11/16	11/16	3/8	13/16	.87	#6-32	PLB5011SF09-3/16	54799	PLB5011DF09-3/16	54846	
12	.752	.707	3/16 1/4							PLB5011SF09-1/4	54800	PLB5011DF09-1/4	54847	
13	.815	.770	3/16 1/4							PLB5012SF09-3/16	54801	PLB5012DF09-3/16	54848	
										PLB5012SF09-1/4	54802	PLB5012DF09-1/4	54849	
14	.877	.832	3/16 1/4							PLB5013SF09-3/16	54803	PLB5013DF09-3/16	54850	
										PLB5013SF09-1/4	54804	PLB5013DF09-1/4	54851	
15	.940	.895	1/4 5/16 3/8							PLB5014SF09-3/16	54805	PLB5014DF09-3/16	54852	
										PLB5014SF09-1/4	54806	PLB5014DF09-1/4	54853	
16	1.003	.958	1/4 5/16 3/8							PLB5015SF09-1/4	54807	PLB5015DF09-1/4	54854	
										PLB5015SF09-5/16	54808	PLB5015DF09-5/16	54855	
										PLB5015SF09-3/8	54809	PLB5015DF09-3/8	54856	
17	1.065	1.020	1/4 5/16 3/8							PLB5016SF09-1/4	54810	PLB5016DF09-1/4	54857	
				PLB5016SF09-5/16	54811	PLB5016DF09-5/16	54858							
				PLB5016SF09-3/8	54812	PLB5016DF09-3/8	54859							
18	1.128	1.083	1/4 5/16 3/8	PLB5017SF09-1/4	54813	PLB5017DF09-1/4	54860							
				PLB5017SF09-5/16	54814	PLB5017DF09-5/16	54861							
				PLB5017SF09-3/8	54815	PLB5017DF09-3/8	54862							
19	1.191	1.146	1/4 5/16 3/8	PLB5018SF09-1/4	54816	PLB5018DF09-1/4	54863							
				PLB5018SF09-5/16	54817	PLB5018DF09-5/16	54864							
				PLB5018SF09-3/8	54818	PLB5018DF09-3/8	54865							
20	1.253	1.208	1/4 5/16 3/8	PLB5019SF09-1/4	54819	PLB5019DF09-1/4	54866							
				PLB5019SF09-5/16	54820	PLB5019DF09-5/16	54867							
				PLB5019SF09-3/8	54821	PLB5019DF09-3/8	54868							
22	1.379	1.334	1/4 5/16 3/8	PLB5020SF09-1/4	54822	PLB5020DF09-1/4	54869							
				PLB5020SF09-5/16	54823	PLB5020DF09-5/16	54870							
				PLB5020SF09-3/8	54824	PLB5020DF09-3/8	54871							
25	1.566	1.521	1/4 5/16 3/8	PLB5022SF09-1/4	54825	PLB5022DF09-1/4	54872							
				PLB5022SF09-5/16	54826	PLB5022DF09-5/16	54873							
				PLB5022SF09-3/8	54827	PLB5022DF09-3/8	54874							
28	1.754	1.709	1/4 5/16 3/8	PLB5025SF09-1/4	54828	PLB5025DF09-1/4	54875							
				PLB5025SF09-5/16	54829	PLB5025DF09-5/16	54876							
				PLB5025SF09-3/8	54830	PLB5025DF09-3/8	54877							
29	1.817	1.772	1/4 5/16 3/8	PLB5028SF09-1/4	54831	PLB5028DF09-1/4	54878							
				PLB5028SF09-5/16	54832	PLB5028DF09-5/16	54879							
				PLB5028SF09-3/8	54833	PLB5028DF09-3/8	54880							
30	1.880	1.835	1/4 5/16 3/8	PLB5029SF09-1/4	54834	PLB5029DF09-1/4	54881							
				PLB5029SF09-5/17	54835	PLB5029DF09-5/16	54882							
				PLB5029SF09-3/8	54836	PLB5029DF09-3/8	54883							
40	2.506	2.461	1/4 5/16 1/2	PLB5030SF09-1/4	54837	PLB5030DF09-1/4	54884							
				PLB5030SF09-5/16	54838	PLB5030DF09-5/16	54885							
				PLB5030SF09-3/8	54839	PLB5030DF09-3/8	54886							
50	3.133	3.088	5/16 3/8 1/2	PLB5040SF09-5/16	54840	PLB5040DF09-5/16	54887							
				PLB5040SF09-3/8	54841	PLB5040DF09-3/8	54888							
				PLB5040SF09-1/2	54842	PLB5040DF09-1/2	54889							
											PLB5050SF09-5/16	54843	PLB5050DF09-5/16	54890
											PLB5050SF09-3/8	54844	PLB5050DF09-3/8	54891
											PLB5050SF09-1/2	54845	PLB5050DF09-1/2	54892

†7/8" for Double Flange
*No Flange

Section Contents

BOST-BRONZ (OIL-IMPREGNATED SINTERED BRONZE)	
General Description.....	136–137
Catalog Number Selections/Dimensions	138–144
BEAR-N-BRONZ (660 CAST BRONZE)	
General Description.....	145
Catalog Number Selections/Dimensions	146–153
BRONZE BEARING EMERGENCY BANK	
BOST-BRONZ & BEAR-N-BRONZ.....	154
BOSTonE F-1 (GLASS FILLED TEFLON)	
General Description/Engineering.....	155
Catalog Number Selections/Dimensions	156–157
RULON® 641 BEARINGS	
General Description.....	158
Catalog Number Selections/Dimensions	159
BOSTonE MOLDED PLASTIC	
General Description/Engineering.....	160
Catalog Number Selections/Dimensions	161–171
BOSTonE MOLDED NYLON	
Catalog Number Selections/Dimensions	172–173
Engineering Information.....	174–182
ANTI-FRICTION (BALL BEARINGS)	
General Description.....	183–184
Catalog Number Selections/Dimensions	185–197
SELF-ALIGNING (ROD END & SPHERICAL BEARINGS)	
Catalog Number Selections/Dimensions	198–206
Engineering Information.....	207–211
MOUNTED BEARINGS	
General Description.....	212
Replacement Bearings & Locking Collars.....	213–214
Pillow Blocks	215–222
Flanged Units	223–230
Shaft Supports	231
Take-Up Frames	232
Stainless Steel Pillow Blocks with Setscrew Locking.....	233
Stainless Steel Pillow Blocks with Eccentric Locking Collar	234
Stainless Steel 2 Bolt Flange	235
Stainless Steel 4 Bolt Flange	236
Stainless Steel 3 Bolt Flange Bracket.....	237
Stainless Steel Take Up Units	238
ENGINEERING INFORMATION	239–245

BOST-BRONZ Oil-Impregnated Sintered Bronze Bearings

F



BOST-BRONZ is Boston Gear's all-purpose, oil-impregnated porous bronze bearing material. It is manufactured of highest purity metal powders by the powder metallurgy process. This process provides uniformly distributed pores between the metal particles which absorb oil by capillary action. BOST-BRONZ has a self-contained oil supply (approximately 20% by volume) which provides a uniform, protective film over the entire bearing surface. Composition and physical properties are as follows: –

BOST-BRONZ can be used for production and replacement requirements in practically every known industry. It has proven to be efficient under heavy loads at moderate speeds and also under light loads at high speeds. It is ideally suited for applications where normal lubrication is difficult or impossible to provide.

Coefficient of Friction	
Static	.1 - .3
Dynamic	.02 - .04

Accuracy

The close tolerances of BOST-BRONZ bearings are made possible through expertly controlled manufacturing methods. In addition, the lubricating features of BOST-BRONZ permit reduced shaft clearances — a precision product with precision performance.

Performance

Because of its porous construction, BOST-BRONZ bearings have an oil reservoir when idle — an oil film to start on — an oil film to run on, assuring low starting torque and smooth, quiet positive performance.

Adaptability

BOST-BRONZ bearings are designed for immediate installation and may be used in most applications without additional machining. Oil holes or grooves are not required and turning or boring bearing diameters is normally unnecessary.

Composition %	Density in Grams per Cu. Cent. Impregnated	Tensile Strength Lbs. per Sq. In.	Yield Strength in Compression (0.2% Offset) Lbs. per Sq. In.	Elongation in One Inch %	Porosity by Volume %
Copper (Cu) 87.5-90.5 Iron 1.0 Max. Lead (a) Carbon (Graphite Max.) 1.75 Max. Tin 9.5-10.5 Total Other Elements .05	6.4/6.8	14,000	11,000	1.0	19 Min.
Conforms to ASTM B438-73 Grade 1, Type 2, and SAE-841 Mil-B-5687C TYPE 1 comp A (Ref:Oil is a SAE 20-30 weight)					

(a) Included in other elements

BOST-BRONZ Oil-Impregnated Sintered Bronze Bearings

Non-Listed Sizes

The stock sizes of BOST-BRONZ bearings listed in this catalog will satisfy the majority of industrial applications. Tooling is available for many metric and additional inch sizes. Where tooling is not available, special sizes can be made to order.

Special Shapes

Many special shapes can be made economically by the powdered metal process. This process is particularly economical for the production of comparatively simple shapes in large volume. More complicated shapes may also be economical to produce by this process when the savings in machining justify the cost of more expensive tooling.

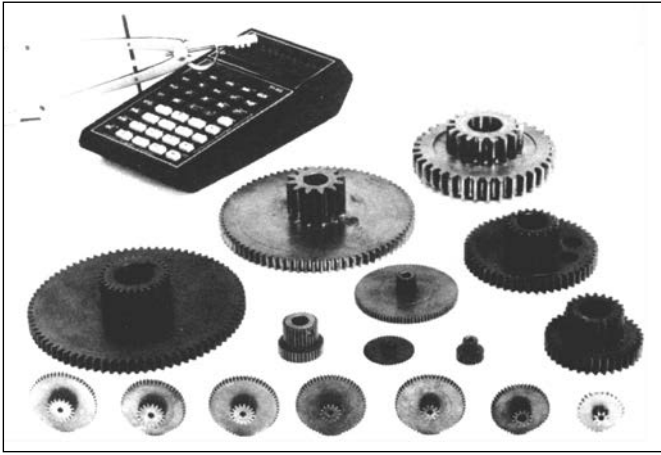

Special Compositions

In addition to our standard BOST-BRONZ, many special compositions can be furnished on a made-to-order basis.

Applications

BOST-BRONZ bearings can be used on any application where the load-carrying capacity required falls within the capabilities of the material. BOST-BRONZ bearings operate efficiently under heavy loads at slow speeds. Because these bearings are supplied with oil impregnation, the original oil content provides long-lasting lubrication. For even longer life requirements, many applications incorporate impregnated felts or other reservoir techniques about the bearing.

Selection

In general, sleeve bearings should be selected with a length of one to two times the shaft diameter and an O.D. approximately 25% larger than the shaft diameter.

A general guide to determination of limiting load and velocity values for sleeve bearings has been established by the use of PV calculations. PV represents Pressure x Velocity, for example 100 psi x 20 fpm yields a PV of 2000.

Maximum PV values for BOST-BRONZ bearings:

Cylindrical & Flange Bearings - 50,000
Thrust Bearings - 10,000

For complete selection and application information, see Engineering Section, Pages 174-182.

F

BOST-BRONZ Oil-Impregnated Sintered Bronze Bearings

Plain Cylindrical Bearings

ALL DIMENSIONS IN INCHES
ORDER BY CATALOG NUMBER OR ITEM CODE



F

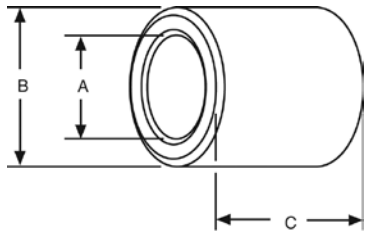

STANDARD TOLERANCES

DIMENSIONS		TOLERANCE
A	1/8 – 1 1/2	+ .000, – .001
	1 3/4 – 2 1/2	+ .000, – .0015
B	2 3/4 – 3 1/2	+ .000, – .002
C	1/8 – 1-1/2	± .005
	1 3/4 – 3	± .0075
	4	± .010

CONCENTRICITY

DIMENSIONS		TOLERANCE
A	1/8 – 1 1/2	.003
	1 5/8 – 3	.004
	3 1/4 – 3 1/2	.005

Prices on unlisted sizes and other Boston Gear powder metal parts provided on request.

A	B	C	Catalog Number	Item Code	A	B	C	Catalog Number	Item Code			
1/8 .127	1/4 .252	1/8	B24-1	34504	3/8 .377	9/16 .5645	3/8	B69-3	34648			
		1/4	B24-2	34506			1/2	B69-4	34650			
		3/8	B24-3	34508			5/8	B69-5	34652			
		1/2	B24-4	34510			3/4	B69-6	34654			
	1/8	B25-1	34512	7/8			B69-7	34656				
3/16 .189	1/4 .252	1/4	B34-2	34522		1	B69-8	34658	1-1/4	B69-10	34660	
		3/8	B34-3	34524		3/8	B610-3	34676	1/2	B610-4	34678	
		1/2	B34-4	34526		5/8	B610-5	34680	3/4	B610-6	34682	
		5/8	B34-5	34528		7/8	B610-7	34684	1	B610-8	34686	
		3/4	B34-6	34530		1-1/4	B610-10	34688	3/8	B612-3	34690	
	5/16 .314	1/4	B35-2	34532	1/2	B612-4	34692	3/4	B612-6	34694		
		3/8	B35-3	34534	1	B612-8	34696	1-1/4	B612-10	34698		
		1/2	B35-4	34536	3/8	B79-3	34662	1/2	B79-4	34664		
	3/8 .377	5/16 .314	3/8	B35-5	34538	3/4	B79-6	34668	7/8	B79-7	34670	
			5/8	B35-6	34540	1	B79-8	34672	1-1/4	B79-10	34674	
			3/4	B36-3	13561	1	B79-9	34676	3/8	B710-3	34700	
1/2			B36-4	13563	1-1/4	B710-4	34702	1/2	B710-5	34704		
5/8			B36-5	13565	3/4	B710-6	34706	5/8	B710-7	34708		
7/16 .439		3/8 .377	3/4	B36-6	13567	7/8	B710-8	34710	1	B710-9	34712	
			1/4	B45-2	13569	1-1/4	B710-10	34714	1-1/8	B810-4	34720	
			3/8	B45-3	13571	1	B711-4	34716	5/8	B810-5	34722	
			1/2	B45-4	13573	1-1/2	B711-8	34718	3/4	B810-6	34724	
			3/4	B45-6	13575	1-1/2	B711-12	34718	7/8	B810-7	34726	
1/4 .252	7/16 .439	1/4	B46-2	34542	1	B810-8	34728	1	B810-9	34730		
		5/16	B46-2 1/2	34544	1-1/8	B810-9	34732	1-1/4	B810-10	34734		
		3/8	B46-3	34546	1-1/4	B810-10	34736	1-1/2	B810-12	34734		
		1/2	B46-4	34548	1-1/2	B811-4	34736	1/2	B811-5	34738		
		5/8	B46-5	34550	3/4	B811-5	34738	5/8	B811-6	34740		
	1/2 .502	3/8 .377	3/4	B46-6	34552	7/8	B811-7	34742	3/4	B811-6	34740	
			7/8	B46-7	34554	1	B811-8	34744	1-1/8	B811-9	34746	
			1	B46-8	34556	1-1/4	B811-10	34748	1-1/4	B811-10	34748	
			1-1/4	B46-10	34558	1-1/2	B811-12	34750	1-1/2	B811-12	34750	
			3/8	B47-3	34560	1-1/8	B811-9	34746	1/2	B812-4	34752	
			1/2	B47-4	34562	1-1/4	B811-10	34748	5/8	B812-5	34754	
5/16 .314	7/16 .439	5/8	B47-5	34564	3/4	B812-6	34756	3/4	B812-6	34756		
		3/4	B47-6	34566	7/8	B812-7	34758	7/8	B812-7	34758		
		7/8	B47-7	34568	1	B812-8	34760	1	B812-8	34760		
		1	B47-8	34570	1-1/8	B812-9	34762	1-1/8	B812-9	34762		
		3/8	B48-3	34572	1-1/4	B812-10	34764	1-1/4	B812-10	34764		
	1/2 .502	3/8 .377	1/2	B48-4	34574	1-1/2	B812-12	34766	1-1/2	B812-12	34766	
			5/8	B48-5	34576	1-3/4	B812-14	34768	1-3/4	B812-14	34768	
			3/4	B48-6	34578	2	B812-16	34770	2	B812-16	34770	
			7/8	B48-7	34580	13/16 .815	1/2	B813-4	34772	3/4	B813-6	34774
			1	B48-8	34582	1	B813-8	34776	1	B813-8	34776	
			1-1/4	B48-10	34584	1-1/2	B813-12	34778	1-1/2	B813-12	34778	
3/8 .377	5/16 .314	3/8	B56-3	34586	1/2 .503	3/4 .753	1/2	B814-4	34780			
		1/2	B56-4	34588			5/8	B814-5	34782			
		5/8	B56-5	34590			3/4	B814-6	34784			
		3/4	B56-6	34592			7/8	B814-7	34786			
		7/8	B56-7	34594			1	B814-8	34788			
	1/2 .502	3/8 .377	1	B56-8		34596	1-1/4	B814-10	34790			
			1-1/4	B57-2		34598	1-1/2	B814-12	34792			
			3/8	B57-3		34600	1	B816-6	13585			
			1/2	B57-4		34602	1	B816-8	13587			
			5/8	B57-5		34604	1-1/2	B816-12	13589			
			3/4	B57-6		34606	2	B816-16	13591			
7/16 .440	5/16 .314	7/8	B57-7	34608	9/16 .565	11/16 .690	3/4	B911-4	34794			
		1	B57-8	34610			5/8	B911-6	34796			
		1-1/4	B57-10	34612			3/4	B911-8	34798			
		1-3/8	B57-11	34614			1	B911-8	34798			
		3/8	B58-3	34616			1-1/2	B911-12	34800			
	3/8 .377	1/2 .502	1/2	B58-4		34618	1	B911-4	34794			
			5/8	B58-5		34620	5/8	B911-6	34796			
			3/4	B58-6		34622	3/4	B911-8	34798			
			7/8	B58-7		34624	1	B911-8	34798			
			1	B58-8		34626	1-1/2	B911-12	34800			
			1-1/4	B58-10		34628	1-1/2	B911-12	34800			
3/8 .377	7/16 .440	1-1/2	B58-12	34630	9/16 .565	11/16 .690	1	B911-4	34794			
		1-3/4	B58-14	34632			5/8	B911-6	34796			
		1/2	B67-4	13577			3/4	B911-8	34798			
		5/8	B67-5	13579			1	B911-8	34798			
		3/4	B67-6	13581			1-1/2	B911-12	34800			
	1/2 .502	3/8 .377	1	B67-8		13583	1	B911-4	34794			
			3/8	B68-3		34634	5/8	B911-6	34796			
			1/2	B68-4		34636	3/4	B911-8	34798			
			5/8	B68-5		34638	1	B911-8	34798			
			3/4	B68-6		34640	1-1/2	B911-12	34800			
			7/8	B68-7		34642	1	B911-12	34800			

On A and B dimensions, tolerances apply to actual (decimal) dimensions.

BOST-BRONZ Oil-Impregnated Sintered Bronze Bearings

ALL DIMENSIONS IN INCHES
ORDER BY CATALOG NUMBER OR ITEM CODE

Plain Cylindrical Bearings

A	B	C	Catalog Number	Item Code	
9/16 .565	3/4 .753	1/2	B912-4	34802	
		3/4	B912-6	34804	
		1	B912-8	34806	
	13/16 .815	1	1-1/2	B912-12	34808
			1/2	B913-4	34810
			3/4	B913-6	34812
1			B913-8	34814	
5/8 .627	3/4 .753	1-1/4	B913-10	34816	
		1-1/2	B913-12	34818	
		1/2	B1012-4	34820	
		5/8	B1012-5	34822	
		3/4	B1012-6	34824	
		7/8	B1012-7	34826	
	13/16 .815	1	1	B1012-8	34828
			1-1/8	B1012-9	34830
			1-1/4	B1012-10	34834
			1-1/2	B1012-12	34832
			1/2	B1013-4	34836
			5/8	B1013-5	34838
5/8 .628	1 1.003	3/4	B1013-6	34840	
		7/8	B1013-7	35400	
		1	B1013-8	34842	
		1-1/4	B1013-10	34844	
		1-1/2	B1013-12	34846	
		2	B1013-16	34848	
	7/8 .878	1	5/8	B1014-5	34850
			3/4	B1014-6	34852
			7/8	B1014-7	34854
			1	B1014-8	34856
			1-1/4	B1014-10	34858
			1-1/2	B1014-12	34860
11/16 .690	7/8 .878	1-3/4	B1014-14	34862	
		2	B1014-16	34864	
		1/2	B1016-4	34866	
		5/8	B1016-5	34868	
		3/4	B1016-6	34870	
		7/8	B1016-7	34872	
3/4 .753	15/16 .9405	1	B1016-8	34874	
		1-1/4	B1016-10	34876	
		1-1/2	B1016-12	34878	
		1-3/4	B1016-14	34880	
		2	B1016-16	34882	
		3/4	B1114-6	34884	
3/4 .753	7/8 .878	1	B1114-8	34886	
		1-1/4	B1114-10	34888	
		1-1/2	B1114-12	34890	
		1-3/4	B1114-14	34892	
		2	B1114-16	34894	
		1/2	B1214-4	34896	
	15/16 .9405	1	5/8	B1214-5	34898
			3/4	B1214-6	34900
			7/8	B1214-7	34902
			1	B1214-8	34904
			1-1/4	B1214-10	34906
			1-1/2	B1214-12	34908
1 1.004	1.003	1-5/8	B1214-13	34910	
		1/2	B1215-4	34912	
		5/8	B1215-5	34914	
		3/4	B1215-6	34916	
		7/8	B1215-7	34918	
		1	B1215-8	34920	
	1	1.3155	1-1/4	B1215-10	34922
			1-1/2	B1215-12	34924
			1-3/4	B1215-14	34926
			2	B1215-16	34928
			1/2	B1216-4	34930
			5/8	B1216-5	34932
1 1.003	1	3/4	B1216-6	34934	
		7/8	B1216-7	34936	
		1	B1216-8	34938	
		1-1/8	B1216-9	34940	
		1-1/4	B1216-10	34942	
		1-1/2	B1216-12	34944	
	1	1.3155	1-3/4	B1216-14	34946
			2	B1216-16	34948
			2-1/2	B1216-20	34950

A	B	C	Catalog Number	Item Code	
3/4 .753	1-1/8 1.128	1/2	B1218-4	34952	
		3/4	B1218-6	34954	
		1	B1218-8	34956	
		1-1/4	B1218-10	34958	
		1-1/2	B1218-12	34960	
		1-3/4	B1218-14	34962	
13/16 .8155	1 1.003	2	B1218-16	34964	
		3/4	B1220-6	34966	
		1	B1220-8	34968	
		1-1/4	B1220-10	34970	
		1-1/2	B1220-12	34972	
		2	B1220-16	34976	
7/8 .878	1-1/8 1.128	3/4	B1316-6	34978	
		1	B1316-8	34980	
		1-1/4	B1316-10	34982	
		1-1/2	B1316-12	34984	
		1-3/4	B1316-14	34986	
		2	B1316-16	34988	
15/16 .9405	1-3/16 1.1905	3/4	B1416-6	34990	
		7/8	B1416-7	34992	
		1	B1416-8	34994	
		1-1/4	B1416-10	34996	
		1-1/2	B1416-12	34998	
		3/4	B1418-6	35000	
	1-1/4 1.253	1-1/8 1.128	7/8	B1418-7	35002
			1	B1418-8	35004
			1-1/8	B1418-9	35006
			1-1/4	B1418-10	35008
			1-3/8	B1418-11	35010
			1-1/2	B1418-12	35012
1 1.004	1-1/4 1.253	1-3/4	B1418-14	35014	
		2	B1418-16	35016	
		2-1/2	B1418-20	35018	
		3/4	B1420-6	35020	
		1	B1420-8	35022	
		1-1/4	B1420-10	35024	
	1-1/8 1.128	1-3/16 1.1905	1-1/2	B1420-12	35026
			2	B1420-16	35028
			3/4	B1519-6	35030
			1	B1519-8	35032
			1-1/4	B1519-10	35034
			1-1/2	B1519-12	35036
1 1.004	1-1/4 1.253	2	B1519-16	35038	
		3/4	B1520-6	35040	
		1	B1520-8	35042	
		1-1/4	B1520-10	35044	
		1-3/4	B1520-14	35048	
		2	B1520-16	35050	
	1-1/8 1.128	1-3/16 1.190	3/4	B1618-6	35052
			1	B1618-8	35054
			1-1/4	B1618-10	35056
			1-1/2	B1618-12	35058
			1-3/4	B1618-14	35060
			2	B1618-16	35062
1 1.004	1-3/16 1.190	3/4	B1619-6	13593	
		1	B1619-8	13595	
		1-1/4	B1619-10	13597	
		1-1/2	B1619-12	13599	
		1-3/4	B1619-14	13601	
		2	B1619-16	13603	
	1-1/4 1.253	1-1/8 1.128	3/4	B1620-6	35064
			7/8	B1620-7	35066
			1	B1620-8	35068
			1-1/4	B1620-10	35070
			1-3/8	B1620-11	35072
			1-1/2	B1620-12	35074
1-5/16 1.3155	1-1/4 1.253	1-3/4	B1620-14	35076	
		2	B1620-16	35078	
		2-1/4	B1620-18	35080	
		2-1/2	B1620-20	35082	
		3	B1620-24	35084	
		1	B1621-8	35086	
1-1/8 1.3155	1-1/4 1.3155	1-1/4	B1621-10	35088	
		1-1/2	B1621-12	35090	
		1-3/4	B1621-14	35092	
		2	B1621-16	35094	
		2-1/2	B1621-20	35096	
		3	B1621-24	35098	

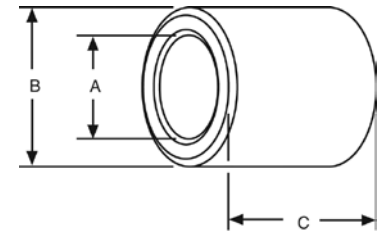

STANDARD TOLERANCES

DIMENSIONS	TOLERANCE
A	1/8 - 1 1/2 1 3/4 - 2 1/2
B	2 3/4 - 3 1/2
C	1/8 - 1 1/2 1 3/4 - 3 4
	+ .000, - .001 + .000, - .0015 + .000, - .002 ± .005 ± .0075 ± .010

CONCENTRICITY

DIMENSIONS	TOLERANCE
A	1/8 - 1 1/2 1 5/8 - 3 3 1/4 - 3 1/2
	.003 .004 .005

Prices on unlisted sizes and other Boston Gear powder metal parts provided on request.

On A and B dimensions, tolerances apply to actual (decimal) dimensions.

BOST-BRONZ Oil-Impregnated Sintered Bronze Bearings

Plain Cylindrical Bearings

F

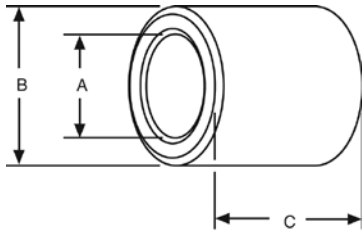

STANDARD TOLERANCES

DIMENSIONS		TOLERANCE
A	1/8 – 1 1/2	+ .000, – .001
	1 3/4 – 2 1/2	+ .000, – .0015
B	2 3/4 – 3 1/2	+ .000, – .002
	1/8 – 1 1/2	± .005
C	1 3/4 – 3	± .0075
	4	± .010

CONCENTRICITY

DIMENSIONS		TOLERANCE
A	1/8 – 1 1/2	.003
	1 5/8 – 3	.004
	3 1/4 – 3 1/2	.005

Prices on unlisted sizes and other Boston Gear powder metal parts provided on request.

ALL DIMENSIONS IN INCHES
ORDER BY CATALOG NUMBER OR ITEM CODE

A	B	C	Catalog Number	Item Code	A	B	C	Catalog Number	Item Code			
1 1.003	1-3/8 1.378	1	B1622-8	35100	1-7/16 1.4405	1-3/4 1.753	1	B2328-8	35252			
		1-1/4	B1622-10	35102			1-1/4	B2328-10	35254			
		1-1/2	B1622-12	35104			1-1/2	B2328-12	35256			
		1-3/4	B1622-14	35106			1-3/4	B2328-14	35258			
		2	B1622-16	35108			2	B2328-16	35260			
		2-1/2	B1622-20	35110			2-1/2	B2328-20	35262			
1-1/2 1.503	1-1/2 1.503	3	B1622-24	35112	1-1/2 1.503	1-3/4 1.753	3	B2328-24	35264			
		1	B1624-8	35114			1	B2428-8	35266			
		1-1/2	B1624-12	35118			1-1/4	B2428-10	35268			
		2	B1624-16	35120			1-1/2	B2428-12	35270			
		2-1/2	B1624-20	35122			2	B2428-16	G00602			
		3	B1624-24	35124			2-1/2	B2428-20	35274			
1-1/16 1.0655	1-5/16 1.3155	1	B1721-8	35126	1-1/2 1.503	1-7/8 1.878	3	B2428-24	35276			
		1-1/2	B1721-12	35128			1-13/16 1.816	1-1/2	B2429-12	35278		
		2	B1721-16	35130				3	B2429-24	35280		
		2-1/2	B1721-20	35132			1-1/2 1.503	1-7/8 1.878	1-1/2	B2430-12	35282	
		1	B1820-8	13605					2	B2430-16	35284	
		1-1/8 1.129	1-3/8 1.378	1-1/4			B1820-10	13639	1-5/8 1.628	1-7/8 1.878	3	B2430-20
1-1/2	B1820-12			13641	2 2.004	1-1/2	B2430-24	35288				
1	B1821-8			35134		2-1/2	B2432-8	35290				
1-1/4	B1821-10			35136	1	B2432-12	35292					
1-1/2	B1821-12			35138	2	B2432-16	35294					
2	B1821-16			35140	2-1/2	B2432-20	35296					
1-1/8 1.129	1-3/8 1.378	3	B1821-20	35142	1-5/8 1.628	1-7/8 1.878	3	B2432-24	35298			
		1	B1822-8	35144			2 2.004	1-1/4	B2630-10	35300		
		1-1/4	B1822-10	35146				1-1/2	B2630-12	35302		
		1-1/2	B1822-12	35148			2	B2630-16	35304			
		1-3/4	B1822-14	35150			2-1/2	B2630-20	35306			
		2	B1822-16	35152			3	B2630-24	35308			
1-1/2 1.503	1-1/2 1.503	2-1/2	B1822-20	35154	1-11/16 1.6905	2-3/16 2.191	3	B2630-24	35310			
		3	B1822-24	35156			2 2.004	2	B2632-8	35312		
		1	B1824-8	35158				2	B2632-16	35314		
		1-1/4	B1824-10	35160			1-3/4 1.753	3	B2632-24	35316		
		1-1/2	B1824-12	35162				2 2.004	1-3/4	B2735-14	35318	
		1-1/4	B1923-10	35164			2		B2735-16	35320		
1-3/16 1.1905	1-1/2 1.503	2	B1923-12	35166	1-3/4 1.753	2-1/8 2.129	3	B2735-18	35322			
		2-1/2	B1923-16	35168			2 2.004	2	B2832-16	35324		
		3	B1923-20	35170				2-1/2	B2832-20	35326		
		1	B1924-8	35172			3	B2832-24	35328			
		1-1/4	B1924-10	35174			1-15/16 1.9405	2-5/16 2.316	1-1/2	B2834-12	35330	
		1-1/2	B1924-12	35176					2	B2834-16	35332	
1-1/4 1.254	1-1/2 1.503	1-3/4	B1924-14	35178	2 2.003	2-3/8 2.379	3	B2834-24	35334			
		2	B1924-16	35180			2-1/2 2.504	2	B3137-16	35336		
		2-1/2	B1924-20	35182				3	B3137-24	35338		
		3	B1924-24	35184			2-1/4 2.254	2-3/4 2.754	4	B3137-32	35340	
		1	B2024-8	35186					2 2.003	2-3/8 2.379	1-3/4	B3238-14
		1-1/8	B2024-9	35188			2	B3238-16			35344	
1-1/2 1.503	1-1/2 1.503	1-1/4	B2024-10	35190	1-5/8 1.628	2-1/2 2.504	3	B3238-22	35346			
		1-3/8	B2024-11	35192			3	B3238-24	35348			
		1-1/2	B2024-12	35194			4	B3238-32	35350			
		1-5/8	B2024-13	35196			2-1/4 2.254	2-3/4 2.754	1	B3240-8	35352	
		1-3/4	B2024-14	35198					2	B3240-16	35354	
		2	B2024-16	35200			3	B3240-24	35356			
1-5/16 1.3155	1-5/8 1.628	2-1/4	B2024-18	35202	1-5/8 1.628	2-3/4 2.754	4	B3240-32	35358			
		2-1/2	B2024-20	35204			2-1/2 2.504	3 3.005	2	B3844-16	35370	
		3	B2024-24	35206					3	B3844-24	35372	
		1	B2026-8	35208			2-1/2 2.504	3 3.005	4	B3844-32	35374	
		1-1/4	B2026-10	35210					2-1/2 2.504	3 3.005	2	B4048-16
		1-1/2	B2026-12	35212			3	B4048-24			35384	
1-3/8 1.378	1-3/4 1.753	1-3/4	B2026-14	35214	1-3/8 1.378	1-3/4 1.753	4	B4048-32	35386			
		2	B2026-16	35216			2-3/4 2.755	3-1/4 3.255	2	B4452-16	35388	
		2-1/2	B2026-20	35218					3	B4452-24	35390	
		3	B2026-24	35220			4	B4452-32	35392			
		1-1/4	B2126-10	35222			3 3.004	3-1/2 3.505	2 2.000	2	B4856-16	35394
		1-1/2	B2126-12	35224						3	B4856-24	35396
1-3/8 1.378	1-3/4 1.753	2	B2126-16	35226	1-3/8 1.378	1-3/4 1.753	4	B4856-32	35398			
		2-1/2	B2126-20	35228			1-1/2 1.503	2-1/2 2.500	1	B2226-12	35234	
		3	B2126-24	35230					2	B2226-16	35236	
		1	B2226-8	35238			3	B2226-20	35240			
		1-1/2	B2226-12	35242			1-1/2 1.503	2-1/2 2.500	1	B2228-8	35242	
		2	B2226-16	35244					1-1/2	B2228-12	35244	
1-3/8 1.378	1-3/4 1.753	2-1/2	B2226-24	35246	1-3/8 1.378	1-3/4 1.753	2	B2228-16	35246			
		3	B2228-8	35248			2-1/2	B2228-20	35248			
		1	B2228-12	35250			3	B2228-24	35250			

On A and B dimensions, tolerances apply to actual (decimal) dimensions.

BOST-BRONZ Oil-Impregnated Sintered Bronze Bearings

Flanged Type

ALL DIMENSIONS IN INCHES
ORDER BY CATALOG NUMBER OR ITEM CODE

A	B	C	D	E	Catalog Number	Item Code			
1/8 .127	5/16 .315	1/4 3/8	.375	3/64	FB25-2 FB25-3	35516 35518			
3/16 .189	5/16 .3145	1/8 1/4 3/8	.375	3/64	FB35-1 FB35-2 FB35-3	35520 35522 35524			
1/4 .252	3/8 .377	1/4 3/8 1/2 5/8 3/4	.500	3/64	FB46-2 FB46-3 FB46-4 FB46-5 FB46-6	35526 35528 35530 35532 35534			
5/16 .314	3/8 .377	3/8	.500	3/64	FB56-3	35536			
	7/16 .439	3/8	.625	3/32	FB57-3	35538			
		1/2			FB57-4	69191			
		5/8			FB57-5	69192			
		3/4			FB57-6	35540			
		7/8			FB57-7	69193			
	1	FB57-8	69194						
	1/2 .502	3/8 1/2 5/8	.688	3/32	FB58-3 FB58-4 FB58-5	35542 35544 35546			
3/8 .377	1/2 .502	3/8	.688	3/32	FB68-3	35548			
		13/32			FB68-3 1/4	35550			
		1/2			FB68-4	35552			
		5/8			FB68-5	35554			
		3/4			FB68-6	35556			
	7/8	FB68-7	69195						
	1	FB68-8	35558						
	1-1/4	FB68-10	35560						
	9/16 .5645	1/2 3/4 1-1/4	1/2	.750	1/8	FB69-4	69196		
			3/4			FB69-6	35562		
1-1/4			FB69-10			35564			
5/8 .627	3/8 1/2 5/8 3/4 1 1-1/4	3/8	.875	1/8	FB610-3	69197			
		1/2			FB610-4	35566			
		5/8			FB610-5	39198			
		3/4			FB610-6	35568			
		1			FB610-8	69199			
1-1/4	FB610-10	35570							
7/16 .439	9/16 .565	1/2	.688	1/16	FB79-4	13611			
		5/8			FB79-5	13613			
		3/4			FB79-6	13615			
5/8 .628	5/8 3/4 1-1/4	5/8	.875	1/8	FB710-5	35574			
		3/4			FB710-6	69200			
		1-1/4			FB710-10	35576			
1/2 .502	5/8 .628	1/2	.875	1/8	FB810-4	35578			
		5/8			FB810-5	35580			
		3/4			FB810-6	35582			
		7/8			FB810-7	69201			
		1			FB810-8	35584			
		1-1/4			FB810-10	35586			
		1-1/2			FB810-12	35588			
	1-3/4	FB810-14	35590						
	11/16 .690	1/2 5/8 3/4	1/2	.938	1/8	FB811-4	35592		
			5/8			FB811-5	69202		
			3/4			FB811-6	35594		
		3/4 .753	1/2			1.000	1/8	FB812-4	35596
			5/8					FB812-5	69203
			3/4					FB812-6	35598
7/8			FB812-7					35600	
1	FB812-8	35602							
1-1/4	FB812-10	35604							
1-1/2	FB812-12	35606							
9/16 .565	3/4 .753	1/2 3/4 1	1.000	1/8	FB912-4 FB912-6 FB912-8	69204 69205 35608			

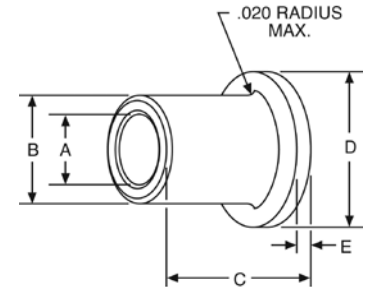

STANDARD TOLERANCES

DIMENSIONS	TOLERANCE	
A	1/8 - 1 1/2 1 3/4 - 2 1/2	+ .000, - .001 + .000, - .0015
B	2 3/4 - 3 1/2	+ .000, - .002
C	1/8 - 1 1/2	± .005
	1 3/4 - 3	± .0075
	4	± .010
D	3/8 - 1 1/4	± .005
	1 3/8 - 2 1/2	± .010
	4	± .015
E	3/8 - 1 1/4	± .0025
	1 3/8 - 2 1/2	± .005
	4	± .010

CONCENTRICITY

DIMENSIONS	TOLERANCE	
A	1/8 - 1 1/2	.003
	1 5/8 - 3	.004
	3 1/4 - 3 1/2	.005

Prices on unlisted sizes and other Boston Gear powder metal parts provided on request.

On A and B dimensions, tolerances apply to actual (decimal) dimensions.

BOST-BRONZ Oil-Impregnated Sintered Bronze Bearings

Flanged Type

F

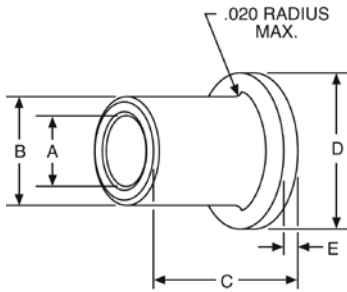

STANDARD TOLERANCES

DIMENSIONS	TOLERANCE
A 1/8 - 1 1/2 1 3/4 - 2 1/2	+ .000, - .001 + .000, - .0015
B 2 3/4 - 3 1/2	+ .000, - .002
C 1/8 - 1 1/2 1 3/4 - 3 4	± .005 ± .0075 ± .010
D 3/8 - 1 1/4 1 3/8 - 2 1/2 4	± .005 ± .010 ± .015
E 3/8 - 1 1/4 1 3/8 - 2 1/2 4	± .0025 ± .005 ± .010

CONCENTRICITY

DIMENSIONS	TOLERANCE
A 1/8 - 1 1/2 1 5/8 - 3 3 1/4 - 3 1/2	.003 .004 .005

Prices on unlisted sizes and other Boston Gear powder metal parts provided on request.

ALL DIMENSIONS IN INCHES ORDER BY CATALOG NUMBER OR ITEM CODE

A	B	C	D	E	Catalog Number	Item Code	
5/8 .626	3/4 .753	1/2	1.000	1/8	FB1012-4	35610	
		5/8			FB1012-5	35612	
		3/4			FB1012-6	35614	
		1			FB1012-8	35616	
		1-1/4			FB1012-10	35618	
5/8 .627	13/16 .815	5/8	1.063	5/32	FB1013-5	69206	
		3/4			FB1013-6	35620	
		1			FB1013-8	35622	
		1-1/4			FB1013-10	35624	
		1-7/16			FB1013-11 1/2	35626	
		1-1/2			FB1013-12	35628	
	2	FB1013-16	35630				
	7/8 .878	1 1.003	5/8	1.125	5/32	FB1014-5	69207
			3/4			FB1014-6	35632
			1			FB1014-8	35634
1-3/4			FB1014-14			35636	
3/4 .752	7/8 .878	3/4	1.125	5/32	FB1214-6	35644	
		1			FB1214-8	35646	
		1-1/4			FB1214-10	69209	
	15/16 .940	1	1.188	5/32	FB1215-8	35648	
		1-1/4			FB1215-10	69213	
		1-1/2			FB1215-12	35650	
	1 1.003	1 1.003	5/8	1.250	5/32	FB1216-5	69214
			3/4			FB1216-6	35652
			1			FB1216-8	35654
			1-1/4			FB1216-10	35656
7/8 .877	1 1.003	1-1/2	1.250	5/32	FB1216-12	35658	
		2			FB1216-16	35660	
		3/4			FB1416-6	35662	
1-1/8 1.128	1 1.128	1	1.375	5/32	FB1416-8	69210	
		1-1/4			FB1416-10	35664	
		1-1/2			FB1418-8	35666	
1 1.002	1 1.002	1-1/4	1.500	3/16	FB1418-10	69211	
		1-1/2			FB1418-12	35668	
		3/4			FB1620-6	35672	
		1			FB1620-8	35674	
1-3/8 1.378	1-3/8 1.378	1-1/4	1.625	3/16	FB1620-10	35676	
		1-1/2			FB1620-12	35678	
		2			FB1620-16	35680	
1-1/8 1.127	1-3/8 1.377	1	1.750	1/8	FB1622-8	35682	
		1-1/2			FB1622-12	69215	
		1-3/4			FB1622-14	35684	
1-1/4 1.252	1-1/2 1.503	3/4	1.750	3/16	FB1822-6	13617	
		1			FB1822-8	13619	
		1-1/4			FB1822-10	13621	
1-3/8 1.377	1-5/8 1.628	1	2.000	1/8	FB2024-8	69216	
		1-1/4			FB2024-10	35686	
		1-1/2			FB2024-12	69217	
1-1/2 1.503	1-3/4 1.754	3/4	2.063	3/16	FB2226-6	13623	
		1			FB2226-8	13625	
		1-1/2			FB2428-12	35688	
2 2.003	2-1/4 2.254	3/4	2.500	1/8	FB3236-6	13627	
		1			FB3236-8	13629	
		1-1/4			FB3236-10	13631	
2-3/4 2.752	3-1/4 3.255	1-1/2	4.000	3/16	FB4452-12	13635	

On A and B dimensions, tolerances apply to actual (decimal) dimensions.

BOST-BRONZ Oil-Impregnated Sintered Bronze Bearings

ALL DIMENSIONS IN INCHES
ORDER BY CATALOG NUMBER OR ITEM CODE

Thrust Type

A	B	C	Catalog Number	Item Code
1/4 .255	7/16 .4375	1/16	TB47	13515
	1/2 .500	1/16	TB48	13517
	5/8 .625	1/16	TB410	35766
5/16 .315	5/8 .625	1/16	TB510	13519
	3/4 .750	1/16	TB512	35768
3/8 .385	5/8 .625	1/16	TB610	13521
3/8 .380	3/4 .750	1/32	TB612	35770
	3/4 .750	1/8	TB612-2	13523
7/16 .440	3/4 .750	1/16	TB712	69218
1/2 .505	3/4 .750	1/16	TB812	35772
1/2 .505	7/8 .875	3/16	TB814	35774
1/2 .510	1 1.000	1/16	TB816	35776
9/16 .565	1-1/4 1.250	1/8	TB920	35778
5/8 .628	1 1.000	1/8	TB1016	35780
	1-3/16 1.187	3/32	TB1019	35782
	1-1/4 1.250	1/8	TB1020	69219
5/8 .6265	1-1/2 1.500	1/8	TB1024	69220
3/4 .753	1-1/4 1.250	1/8	TB1220	69221
	1-3/8 1.375	1/8	TB1222	69222

On A and B dimensions, tolerances apply to actual (decimal) dimensions.

BOST-BRONZ is stocked in this convenient Plate form for ease in machining to required bearing size or shape — at your service for all emergencies.

A	B	C	Catalog Number	Item Code
3/4 .765	1-9/16 1.562	3/32	TB1225	35784
	1-3/4 1.750	1/8	TB1228	35786
7/8 .8905	1-1/2 1.500	1/8	TB1424	35788
	2 2.000	1/8	TB1432	13525
7/8 .8905	2-1/8 2.125	1/8	TB1434	35790
	1-1/2 1.500	1/8	TB1624	35792
1 1.003	1.500	3/16	TB1624-3	13527
1 1.0155	1-5/8 1.625	1/4	TB1626-4	13529
1 1.0120	1-3/4 1.750	1/8	TB1628	13531
1 1.016	2 2.000	1/8	TB1632	35794
1 1.0155	2-7/8 2.875	1/8	TB1646	13533
1-1/8 1.140	1-7/8 1.875	1/8	TB1830	13535
1-1/4 1.253	1-3/4 1.750	1/8	TB2028	35796
1-1/4 1.265	2 2.000	1/8	TB2032	13537
	2-3/8 2.375	1/8	TB2038	13539
	3-5/16 3.312	1/8	TB2053	13541
1-3/8 1.379	1-15/16 1.940	1/8	TB2231	13543
1-1/2 1.503	2 2.000	1/8	TB2432	13545
1-1/2 1.505	2-1/2 2.505	1/8	TB2440	13547
1-1/2 1.510	3-1/2 3.500	3/16	TB2456	35798
1-9/16 1.578	2-7/16 2.4375	1/8	TB2539	13549
1-3/4 1.765	2-5/8 2.625	1/8	TB2842	13551
2 2.011	3 3.000	1/4	TB3248	13553
2 2.031	2-5/8 2.625	3/16	TB3258	13555
2-1/16 2.062	4 4.000	1/8	TB3364	13557
2-1/2 2.502	3-1/4 3.250	1/8	TB4052	13559

ALL DIMENSIONS IN INCHES
ORDER BY CATALOG NUMBER OR ITEM CODE

A	B	C	Catalog Number	Item Code
1/8 3/16 1/4 5/16	5	6	PB5602	35692
			PB5603	35694
			PB5604	35696
			PB5605	35698
3/8 1/2 5/8 3/4 1	5	6	PB5606	35700
			PB5608	35702
			PB5610	35704
			PB5612	35706
			PB5616	35708
3/16 1/4	5	8	PB5803	35710
			PB5804	35712

Keep **BOST-BRONZ** plate stock on hand for: Breakdowns – maintenance and repairs – Producing small lots of special sizes – Experimental and development work.

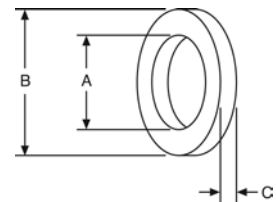

STANDARD TOLERANCES

DIMENSIONS	TOLERANCE
A	1/4 – 1 1/4 1 3/8 – 2 1/2
B	7/16 – 1 1/2 1 9/16 – 3 3 1/4 – 4
C	All

Plate Stock

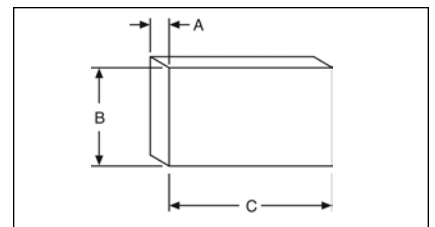
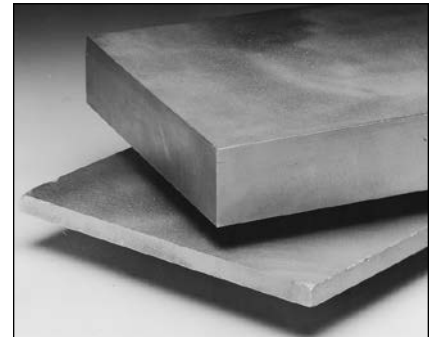

STANDARD TOLERANCES

DIMENSIONS	TOLERANCE
A	All

BOST-BRONZ Oil-Impregnated Sintered Bronze Bearings

Cored Bars

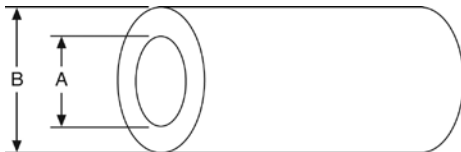
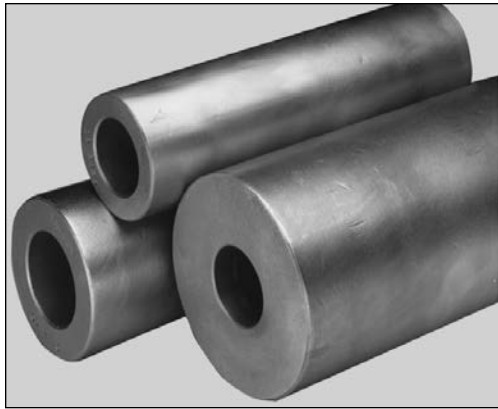

STANDARD TOLERANCES

DIMENSIONS		TOLERANCE
A	All	-1/8"
B	All	+1/8"

BOST-BRONZ is stocked in these convenient Bar forms for ease in machining to required bearing size or shape — at your service for all emergencies.

ALL DIMENSIONS IN INCHES ORDER BY CATALOG NUMBER OR ITEM CODE

A	B	Catalog Number	Item Code
1/2	1	CB816	35402
	1-1/4	CB820	35404
	1-1/2	CB824	35406
5/8	1	CB1016	35408
	1-1/4	CB1020	35410
	1-3/8	CB1022	35412
	1-1/2	CB1024	35414
	1-3/4	CB1028	35416
3/4	1-1/4	CB1220	35418
	1-1/2	CB1224	35420
	1-3/4	CB1228	35422
	2	CB1232	35424
	2-1/2	CB1240	35426
7/8	1-3/8	CB1422	35428
1	1-1/2	CB1624	35430
	1-3/4	CB1628	35432
	2	CB1632	35434
	2-1/4	CB1636	35436
	2-1/2	CB1640	35438
	3	CB1648	35440
1-1/4	1-3/4	CB2028	35442
	2	CB2032	35444
	2-1/4	CB2036	35446
	2-1/2	CB2040	35448
1-3/8	2	CB2048	35450
	2	CB2232	35452
1-1/2	2	CB2432	35456
	2-1/4	CB2436	35458
	2-1/2	CB2440	35460
	3	CB2448	35462
	3-1/2	CB2456	35464

A	B	Catalog Number	Item Code
1-3/4	2-1/4	CB2836	35466
	2-1/2	CB2840	35468
	2-3/4	CB2844	35470
	3	CB2848	35472
	3-1/2	CB2856	35474
2	2-3/4	CB3244	35476
	3	CB3248	35478
	3-1/4	CB3252	35480
	4	CB3264	35482
	4-1/2	CB3272	35484
2-1/4	5	CB3280	35486
	3	CB3648	35488
	3-1/2	CB3656	35490
2-3/8	3-3/4	CB3660	35492
	3	CB3848	35494
2-1/2	3-1/2	CB4056	35496
3	3-3/4	CB4860	35498
	4	CB4864	35500
	5	CB4880	35502
	6	CB4896	35504
3-1/2	4-3/4	CB5676	35506
4	6	CB6496	35512
5	7	CB80112	35514

All bars are 6 1/2" long.

Solid Bars

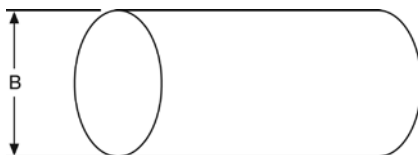

STANDARD TOLERANCES

DIMENSIONS		TOLERANCE
B	All	+ 1/8"

ALL DIMENSIONS IN INCHES ORDER BY CATALOG NUMBER OR ITEM CODE

B	Length	Catalog Number	Item Code
1/4	2	SB4	35714
3/8	3	SB6	35716
1/2	6-1/2	SB8	35718
5/8		SB10	35720
3/4		SB12	35722
7/8		SB14	35724
1		SB16	35726
1-1/8	6-1/2	SB18	35728
1-1/4		SB20	35730
1-3/8		SB22	35732
1-1/2		SB24	35734
1-5/8	6-1/2	SB26	35736
1-3/4		SB28	35738
2		SB32	35742
2-1/4	6-1/2	SB36	35744
2-1/2		SB40	35746
3		SB48	35748
3-1/2		SB56	35750
4		SB64	35752
4-1/2	6-1/2	SB72	35754
5		SB80	35756
5-1/2		SB88	35758
6		SB96	35760
7	6-1/2	SB112	35762

BEAR-N-BRONZE 660 Cast Bronze Bearings



⚠ WARNING: Cancer and Reproductive Harm –
www.P65Warnings.ca.gov

The Chemical compositions and physical properties of some of the more popular are listed.

BEAR-N-BRONZ is Boston Gear's general purpose cast, solid bronze bearing material. It is a high grade, leaded-tin bronze, having good hardness, strength, wear-resistance, and exceptional anti-friction qualities. It is particularly suited for moderate to heavy loads at normal to relatively high speeds.

Quality

BEAR-N-BRONZ is chemically and metallurgically tested to assure conformance to specifications. All parts are rigidly inspected to assure freedom from porosity and conformance to dimensional tolerances.

Adaptability

BEAR-N-BRONZ bearings are completely machined to close tolerances permitting wider housing-bore tolerances. BEAR-N-BRONZ bars are machined all over.

Composition (%)		Avg. Tensile Strength (Lbs. Per Sq. In.)	Avg. Yield Strength 0.2% Offset (Lbs. Per Sq. In.)	Elongation in Two Inch (%)	Brinnell Hardness (500 Kg Load)
Copper (Cu)	83	35,000	20,000	15	60
Tin (Sn)	7	Bear-N-Bronz conforms to SAE CA932 (660) and ASTM B584-78 (alloy C93200) specifications.			
Lead (Pb)	7				
Zinc (Zn)	3				

Special Compositions

In addition to our standard BEAR-N-BRONZ (SAE CA 932) material, many special compositions can be furnished on a made-to-order basis.

Grade	Equivalent S.A.E. Number	Composition (%)	Average Yield Strength 0.2% Offset (Lbs. Per Sq. In.)	Average Tensile Strength (Lbs. Per Sq. In.)	Elongation in Two Inch (%)	Brinnell Hardness (500 Kg Load)
206 Leaded Gun Metal	CA927	Copper (Cu) 88 Tin (Sn) 10 Lead (Pb) 2	40,000	20,000	25	70
210 Gun Metal	CA905	Copper (Cu) 88 Tin (Sn) 10 Zinc (Zn) 2	45,000	22,000	25	65
305 Phosphor Bronze	CA937	Copper (Cu) 80 Tin (Sn) 10 Lead (Pb) 10	35,000	18,000	20	63
319 Semi-Plastic Bronze	CA938	Copper (Cu) 78 Tin (Sn) 7 Lead (Pb) 15	30,000	17,000	15	55

Selection

In general, sleeve bearings should be selected with a length of one to two times the shaft diameter and an O.D. approximately 25% larger than the shaft diameter.

A general guide to determination of limiting load and velocity values for sleeve bearings has been established by the use of PV calculations. PV represents Pressure x Velocity, for example 100 psi x 20 fpm yields a PV of 2000.

Maximum PV value for BEAR-N-BRONZ bearings: 75,000.

For complete selection and application information, see Engineering Section, Pages 174-182.

BEAR-N-BRONZE 660 Cast Bronze Bearings

Plain Cylindrical Bearings

F

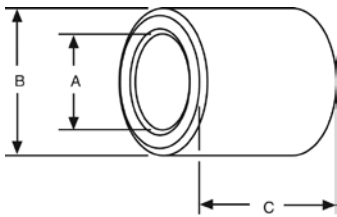

STANDARD TOLERANCES

DIMENSIONS		TOLERANCE
A	3/16 - 3	±.001
	3-1/4 - 4-1/2	±.0015
B	5/16 - 3	+.002 to +.003
	3-1/8 - 5	+.003 to +.005
C	All	±.005

STANDARD CONCENTRICITY

DIMENSIONS		T.I.R. (A TO B)
A	All	.003

For Oil Grooves see Page 179.

ALL DIMENSIONS IN INCHES
ORDER BY CATALOG NUMBER OR ITEM CODE

A	B	C	Catalog Number	Item Code	A	B	C	Catalog Number	Item Code	
3/16	5/16	1/2	M35-4	31308	1/2	1	1-1/2	M816-12	31460	
		3/4	M35-6	31310			2	M816-16	31462	
		1	M35-8	31312			2-1/4	M816-18	31464	
1/4	3/8	3/4	M46-6	31314	9/16	11/16	1	M911-8	31466	
		1	M46-8	31316			1-1/4	M911-10	31468	
		1-1/4	M46-10	31318			1-1/2	M911-12	31470	
	7/16	3/4	M47-6	31320			1-3/4	M911-14	31472	
		1	M47-8	31322			2	M911-16	31474	
		1-1/4	M47-10	31324			2-1/4	M911-18	31476	
5/16	7/16	3/4	M57-6	31326	3/4	1	M912-8	31480		
		1	M57-8	31328		1-1/4	M912-10	31482		
	1-1/4	M57-10	31330	1-1/2		M912-12	31484			
3/8	1/2	3/4	M68-6	31338	13/16	1	M913-8	31494		
		1	M68-8	31340		1-1/4	M913-10	31496		
		1-1/4	M68-10	31342		1-1/2	M913-12	31498		
		1-1/2	M68-12	31344		1-3/4	M913-14	31500		
	9/16	3/4	M69-6	31346	7/8	1	M914-8	31506		
		1	M69-8	31348		1-1/2	M914-12	31508		
		1-1/4	M69-10	31350		2	M914-16	31510		
	5/8	3/4	3/4	M610-6	31362	3/4	1	M1012-8	31512	
			1	M610-8	31364		1-1/8	M1012-9	31514	
			1-1/4	M610-10	31366		1-1/4	M1012-10	31516	
		1-1/2	1-1/4	M610-10	31366		1-1/2	M1012-12	31518	
			1-1/2	M610-12	31368		1-3/4	M1012-14	31520	
2			M610-12	31368	2		M1012-16	31522		
7/16	9/16	1	M79-8	31352	5/8	7/8	2-1/4	M1012-18	31524	
		1-1/4	M79-10	31354			2-1/2	M1012-20	31526	
		1-1/2	M79-12	31356			1	M1013-8	31528	
	5/8	1	M710-8	31370			1-1/4	M1013-10	31530	
		1-1/4	M710-10	31372			1-1/2	M1013-12	31532	
		1-1/2	M710-12	31374			1-3/4	M1013-14	31534	
	11/16	2	M710-16	31376			2	M1013-16	31536	
		1-1/2	M711-12	31378			2-1/4	M1013-18	31538	
		3/4	1	M712-8			31380	2-1/2	M1013-20	31540
			1-1/4	M712-10			31382	3/4	M1014-6	31542
1/2	13/16	1-1/2	M713-12	31386	1	M1014-8	31544			
		5/8	M810-5	31388	1-1/4	M1014-10	31548			
		3/4	M810-6	31390	1-1/2	M1014-12	31550			
		7/8	M810-7	31392	1-3/4	M1014-14	31552			
		1	M810-8	31394	2	M1014-16	31554			
		1-1/4	M810-10	31396	2-1/4	M1014-18	31556			
	11/16	1-3/8	M810-11	31398	2-1/2	M1014-20	31558			
		1-1/2	M810-12	31400	3	M1014-24	31560			
		1-3/4	M810-14	31402	1	M1015-8	31562			
		2	M810-16	31404	1-1/2	M1015-12	31564			
		2-1/4	M810-18	31406	2-1/2	M1015-20	31568			
		2-1/2	M811-6	31408	1	M1016-8	31570			
1/2	11/16	1	M811-8	31410	1	1-1/2	M1016-12	31572		
		1-1/4	M811-10	31412		2	M1016-16	31574		
		1-1/2	M811-12	31414		2-1/4	M1016-18	31576		
		1-3/4	M811-14	31416		2-1/2	M1016-20	31578		
		2	M811-16	31418		3	M1016-24	31580		
		2-1/4	M811-18	31420		1-1/8	M1018-12	31582		
	3/4	2-1/2	M811-20	31422	2	M1018-16	31584			
		3/4	M812-6	31424	2-1/4	M1018-18	31586			
		1	M812-8	31426	11/16	13/16	1	M1113-8	31588	
		1-1/4	M812-10	31428			1-1/2	M1113-12	31592	
		1-1/2	M812-12	31430			1-3/4	M1113-14	31594	
		1-3/4	M812-14	31432			2	M1113-16	31596	
2	M812-16	31434	1	M1114-8			31600			
2-1/4	M812-18	31436	1-1/4	M1114-10			31602			
13/16	2-1/2	M812-20	31438	1-1/2	M1114-12	31604				
	2-3/4	M812-22	31440	2	M1114-16	31608				
	1	M813-8	31442	2-1/2	M1114-20	31612				
	1-1/2	M813-12	31444	15/16	1	M1115-8	31614			
	2-1/4	M813-18	31446		1-1/4	M1115-10	31616			
	1	M814-8	31448		1-1/2	M1115-12	31618			
1-1/4	M814-10	31450	2-1/2		M1115-20	31626				
1-1/2	M814-12	31452	1		1-1/4	M1116-10	31628			
1-3/4	M814-14	31454			2-1/4	M1116-18	31634			
2	M814-16	31456	2-1/2	M1116-20	31636					
1	1	M816-8	31458							

BEAR-N-BRONZE 660 Cast Bronze Bearings

Plain Cylindrical Bearings

ALL DIMENSIONS IN INCHES
ORDER BY CATALOG NUMBER OR ITEM CODE

A	B	C	Catalog Number	Item Code
3/4	7/8	3/4	M1214-6	31640
		1	M1214-8	31642
		1-1/4	M1214-10	31644
		1-1/2	M1214-12	31646
		1-3/4	M1214-14	31648
		2	M1214-16	31650
	15/16	2-1/4	M1214-18	31652
		2-1/2	M1214-20	31654
		1	M1215-8	31656
		1-1/4	M1215-10	31658
		1-1/2	M1215-12	31662
		1-3/4	M1215-14	31664
	1	2	M1215-16	31666
		2-1/4	M1215-18	31668
		2-1/2	M1215-20	31670
		3	M1215-24	31674
		3/4	M1216-6	31676
		1	M1216-8	31678
		1-1/8	M1216-9	31680
		1-1/4	M1216-10	31682
		1-3/8	M1216-11	31684
		1-1/2	M1216-12	31686
		1-3/4	M1216-14	31688
		1-1/16	2	M1216-16
	2-1/8		M1216-17	31692
	2-1/4		M1216-18	31694
	2-1/2		M1216-20	31696
	2-3/4		M1216-22	31698
	3		M1216-24	31700
	3-1/2		M1216-28	31702
	1		M1217-8	31704
	1-1/2		M1217-12	31706
	2		M1217-16	31708
	3		M1217-24	31714
	1-1/8		1	M1218-8
		1-1/2	M1218-12	31718
2		M1218-16	31720	
2-1/2		M1218-20	31724	
3		M1218-24	31726	
1-1/2		M1219-12	31728	
1-3/16	2	M1219-16	31730	
	1-3/4	M1220-14	31734	
	2	M1220-16	31736	
	2-1/2	M1220-20	31740	
	3	M1220-24	31742	
	13/16	1	M1315-8	31744
1-1/2		M1315-12	31748	
2		M1315-16	31750	
1-1/2		M1316-12	31752	
2		M1316-16	31756	
2-1/2		M1316-20	31758	
1-1/16	1-1/2	M1317-12	31760	
	2	M1317-16	31762	
	2-3/4	M1317-22	31766	
	1-1/2	M1318-12	31770	
	2	M1318-16	31772	
	7/8	1	M1416-8	31788
1-1/4		M1416-10	31790	
1-3/8		M1416-11	31792	
1-1/2		M1416-12	31794	
1-5/8		M1416-13	31796	
2		M1416-16	31798	
1-1/16		1	M1417-8	31800
		1-1/4	M1417-10	31802
		1-1/2	M1417-12	31804
		1-3/4	M1417-14	31806
		2	M1417-16	31808
		2-1/4	M1417-18	31810
	2-1/2	M1417-20	31812	
	3	M1417-24	31816	
	1-1/8	3/4	M1418-6	31818
		1	M1418-8	31820
		1-1/4	M1418-10	31822
		1-3/8	M1418-11	31824

A	B	C	Catalog Number	Item Code	
7/8	1-1/8	1-1/2	M1418-12	31826	
		1-3/4	M1418-14	31828	
		2	M1418-16	31830	
		2-1/4	M1418-18	31832	
		2-1/2	M1418-20	31834	
		3	M1418-24	31836	
	1-3/16	3-1/4	M1418-26	31838	
		3-1/2	M1418-28	31840	
		1	M1419-8	31842	
		3	M1419-24	31852	
		1-1/4	1-1/2	M1420-12	31854
			1-3/4	M1420-14	31856
2	M1420-16		31858		
2-1/4	M1420-18		31860		
2-1/2	M1420-20		31862		
3	M1420-24		31864		
1-3/8	3-1/2	M1420-28	31866		
	1-1/2	M1422-12	31868		
	2	M1422-16	31872		
	2-1/2	M1422-20	31874		
	3	M1422-24	31876		
	15/16	1-1/8	1-1/2	M1518-12	31878
2			M1518-16	31880	
1-3/16		1-1/4	M1519-10	31884	
		1-1/2	M1519-12	31886	
		2	M1519-16	31888	
1-1/4		3	M1519-24	31894	
		1	M1520-8	31896	
		1-1/2	M1520-12	31898	
1-5/16		2	M1520-16	31900	
		2-1/2	M1520-20	31902	
		2-3/4	M1520-22	31904	
1		1-1/8	1-1/2	M1521-12	31906
	2		M1521-16	31910	
	1-1/8	1-3/8	M1618-11	31916	
		1-1/2	M1618-12	31918	
		1-3/4	M1618-14	31920	
		2	M1618-16	31922	
	1-3/16	2-1/2	M1618-20	31924	
		7/8	M1619-7	31926	
		1-1/4	M1619-10	31928	
		1-1/2	M1619-12	31930	
		1-3/4	M1619-14	31932	
		2	M1619-16	31934	
1-1/4	2-1/2	M1619-20	31936		
	3/4	M1620-6	31938		
	1	M1620-8	31940		
	1-1/8	M1620-9	31942		
	1-1/4	M1620-10	31944		
	1-3/8	M1620-11	31946		
	1-1/2	M1620-12	31948		
	1-5/8	M1620-13	31950		
	1-3/4	M1620-14	31952		
	2	M1620-16	31954		
	2-1/4	M1620-18	31956		
	2-1/2	M1620-20	31958		
1-5/16	2-3/4	M1620-22	31960		
	3	M1620-24	31962		
	4	M1620-32	31968		
	4-1/2	M1620-36	31970		
	1-1/2	M1621-12	31972		
	2	M1621-16	31974		
1-3/8	2-1/4	M1621-18	31976		
	2-1/2	M1621-20	31978		
	3	M1621-24	31980		
	3-1/2	M1621-28	31982		
	1-1/4	M1622-10	31988		
	1-1/2	M1622-12	31990		
1-3/8	1-3/4	M1622-14	31992		
	2	M1622-16	31994		

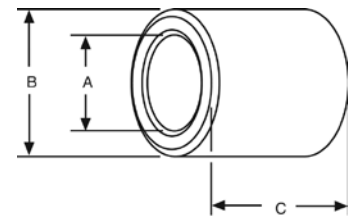

STANDARD TOLERANCES

DIMENSIONS	TOLERANCE
A	3/16 – 3 3-1/4 – 4-1/2
B	±.001 ±.0015 +.002 to +.003 +.003 to +.005
C	All ±.005

STANDARD CONCENTRICITY

DIMENSIONS	T.I.R. (A TO B)
A	All .003

For Oil Grooves see Page 179.

BEAR-N-BRONZE 660 Cast Bronze Bearings

Plain Cylindrical Bearings

F

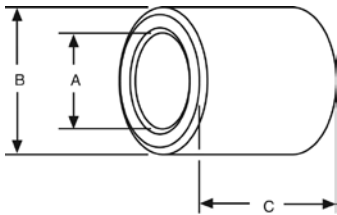

STANDARD TOLERANCES

DIMENSIONS		TOLERANCE
A	3/16 – 3	±.001
	3-1/4 – 4-1/2	±.0015
B	5/16 – 3	+.002 to +.003
	3-1/8 – 5	+.003 to +.005
C	All	±.005

STANDARD CONCENTRICITY

DIMENSIONS		T.I.R. (A TO B)
A	All	.003

For Oil Grooves see Page 179.

ALL DIMENSIONS IN INCHES
ORDER BY CATALOG NUMBER OR ITEM CODE

A	B	C	Catalog Number	Item Code	A	B	C	Catalog Number	Item Code		
1	1-3/8	2-1/2	M1622-20	31996	1-3/16	1-11/16	2	M1927-16	32172		
		2-3/4	M1622-22	31998			2-1/2	M1927-20	32174		
		3	M1622-24	32000			3	M1927-24	32176		
		3-1/2	M1622-28	32004			2-1/2	M2023-20	32180		
		4	M1622-32	32006				3	M2023-24	32182	
	4-1/2	M1622-36	32008	1-7/16		1-1/2	1	M2024-8	32184		
	1-1/2	1-1/2	M1624-12				32010	1-1/8	M2024-9	32186	
		1-3/4	M1624-14				32012	1-1/4	M2024-10	32188	
		2	M1624-16				32014	1-3/8	M2024-11	32190	
		2-1/2	M1624-20				32016	1-1/2	M2024-12	32192	
	3	M1624-24	32018				1-5/8	M2024-13	32194		
	4	M1624-32	32020				1-3/4	M2024-14	32196		
1-5/8	2	M1626-16	32022		2		M2024-16	32198			
	2-1/2	M1626-20	32024		2-1/4		M2024-18	32200			
	3	M1626-24	32026		2-1/2		M2024-20	32202			
	3-1/2	M1626-28	32028		2-3/4		M2024-22	32204			
1-3/4	6-1/2	M1628-52	32030		3		M2024-24	32206			
2	3	M1632-24	32032	3-1/4	M2024-26	32208					
6-1/2	M1632-52	32034	3-1/2	M2024-28	32210						
1-1/16	1-5/16	1-1/2	M1721-12	32036	4	M2024-32	32212				
		2	M1721-16	32038	4-1/4	M2024-34	32214				
		2-1/2	M1721-20	32040	4-1/2	M2024-36	32216				
1-7/16	2-1/2	M1723-20	32050	5	M2024-40	32218					
1-1/4	1-1/4	1-1/2	M1820-12	32062	5-1/2	M2024-44	32220				
		1-3/4	M1820-14	32064	1-9/16	2	M2025-16	32222			
		2	M1820-16	32066		2-1/2	M2025-20	32224			
	1-5/16	2-1/4	M1821-18	32068		3	M2025-24	32226			
		2-1/2	M1821-20	32070		3-1/2	M2025-28	32228			
		3-3/4	M2025-30	32230							
1-3/8	1-3/8	1	M1822-8	32072		1-3/4	M2026-14	32232			
		1-1/4	M1822-10	32074		2	M2026-16	32234			
		1-1/2	M1822-12	32076		2-1/2	M2026-20	32236			
		1-3/4	M1822-14	32078		3	M2026-24	32238			
		2	M1822-16	32080		3-1/4	M2026-26	32240			
		2-1/4	M1822-18	32082		3-1/2	M2026-28	32242			
		2-1/2	M1822-20	32084		4	M2026-32	32244			
		3	M1822-24	32086	4-1/2	M2026-36	32246				
		3-1/4	M1822-26	32088	4-3/4	M2026-38	32248				
		3-1/2	M1822-28	32090	1-11/16	2	M2027-16	32250			
		4	M1822-32	32092		3-1/4	M2027-26	32254			
		1-7/16	1-1/2	M1823-12		32094	1-3/4	M2028-14	32258		
3	M1823-24		32098	2		M2028-16	32260				
1-1/2	1-1/2	1-1/2	M1824-12	32102		2-1/4	M2028-18	32262			
		2	M1824-16	32104		2-1/2	M2028-20	32264			
		2-1/2	M1824-20	32106		2-3/4	M2028-22	32266			
		3	M1824-24	32108		3	M2028-24	32268			
		3-1/2	M1824-28	32110		3-1/2	M2028-28	32270			
		4	M1824-32	32112		3-3/4	M2028-30	32272			
1-5/8	1-5/8	1-3/4	M1826-14	32114		4	M2028-32	32274			
		2	M1826-16	32116		5	M2028-40	32276			
		2-1/2	M1826-20	32118	1-7/8	2	M2030-16	32278			
		3	M1826-24	32120		2-1/2	M2030-20	32280			
		3-1/2	M1826-28	32122		4	M2030-32	32284			
		4-1/2	M1826-36	32126		2	3	M2032-24	32286		
1-7/8	6-1/2	M1830-52	32128	4			M2032-32	32288			
	3	M1832-24	32130	6-1/2			M2032-52	32290			
1-3/16	1-3/8	1-3/4	M1922-14	32134			1-5/16	1-1/2	1-3/4	M2124-14	32296
		2	M1922-16	32136					3	M2124-24	32298
		2-1/2	M1922-20	32138					2	M2126-16	32306
	1-7/16	1-1/4	M1923-10	32140		3		M2126-24	32310		
		1-1/2	M1923-12	32142		4-3/4		M2126-38	32314		
		2	M1923-16	32144		1-13/16		3	M2129-24	32324	
		2-1/2	M1923-20	32146	4			M2129-32	32328		
		3	M1923-24	32148	1-7/8			3-1/2	M2130-28	32330	
	3-1/2	M1923-28	32150	1-1/2		1-3/4		M2224-14	32334		
	1-1/2	2	M1924-16			32152		2	M2224-16	32336	
		3	M1924-24		32154	2-1/2		M2224-20	32338		
		4	M1924-32		32158	1-3/8		2	M2226-16	32340	
1-9/16	3	M1925-24	32162		3		M2226-24	32342			
	3-1/2	M1925-28	32164		3-1/4		M2226-26	32344			
1-5/8	1-5/8	2	M1926-16	32166	3-1/2		M2226-28	32346			
		2-1/2	M1926-20	32168	4		M2226-32	32348			
		3	M1926-24	32170	1-11/16		3-1/2	M2227-28	32352		

BEAR-N-BRONZE 660 Cast Bronze Bearings

Plain Cylindrical Bearings

ALL DIMENSIONS IN INCHES
ORDER BY CATALOG NUMBER OR ITEM CODE

A	B	C	Catalog Number	Item Code
1-3/8	1-3/4	2	M2228-16	32354
		2-1/4	M2228-18	32356
		2-1/2	M2228-20	32358
		3	M2228-24	32360
		3-1/2	M2228-28	32362
	1-7/8	4	M2228-32	32364
		3	M2230-24	32366
		3-1/2	M2230-28	32368
	2	4	M2230-32	32370
		4-1/2	M2230-36	32372
3		M2232-24	32374	
4		M2232-32	32376	
2-1/8	6-1/2	M2234-52	32378	
1-7/16	1-5/8	1-3/4	M2326-14	32380
		2-3/4	M2326-22	32382
		3	M2326-24	32384
	1-11/16	2-1/2	M2327-20	32386
		3	M2327-24	32388
		3-1/2	M2327-28	32390
		4	M2327-32	32392
	1-3/4	2-1/4	M2328-18	32396
		3	M2328-24	32398
		4	M2328-32	32400
	1-13/16	3	M2329-24	32402
		4-1/4	M2329-34	32410
	1-7/8	3	M2330-24	32414
		4	M2330-32	32416
		4-1/2	M2330-36	32420
5		M2330-40	32422	
2		M2331-16	32424	
1-15/16	3	M2331-24	32426	
	4	M2332-32	32438	
2	1-5/8	M2426-16	32440	
1-11/16	2-3/4	M2427-22	32442	
1-3/4	1-3/4	1-3/4	M2428-14	32444
		2	M2428-16	32446
		2-1/4	M2428-18	32448
		2-1/2	M2428-20	32450
		3	M2428-24	32452
		3-1/2	M2428-28	32454
	1-13/16	4	M2428-32	32456
		4-1/2	M2428-36	32458
		5	M2428-40	32460
	5-1/2	M2428-44	32462	
	1-13/16	3	M2429-24	32464
	1-1/2	1-7/8	2	M2430-16
2-1/2			M2430-20	32468
2-3/4			M2430-22	32470
3			M2430-24	32472
3-1/2			M2430-28	32474
4			M2430-32	32476
4-1/2			M2430-36	32478
5			M2430-40	32480
5-1/2			M2430-44	32482
2			2-1/2	M2432-20
		3	M2432-24	32486
		3-1/2	M2432-28	32488
		4	M2432-32	32490
2-1/8		4-1/2	M2432-36	32492
		5	M2432-40	32494
		3	M2434-24	32496
		4	M2434-32	32498
2-1/4		3	M2436-24	32500
	4	M2436-32	32502	
	5	M2436-40	32504	
	6-1/2	M2436-52	32506	
1-9/16	1-13/16	3	M2529-24	32508
	3-1/2	M2529-28	32510	
1-5/8	1-15/16	3-1/2	M2531-28	32514
	1-7/8	2-1/4	M2630-18	32518
		3	M2630-24	32520
3-3/4	M2630-30	32522		

A	B	C	Catalog Number	Item Code	
1-5/8	2	1-3/4	M2632-14	32526	
		2-1/2	M2632-20	32528	
		2	M2632-24	32530	
		4	M2632-32	32534	
		5	M2632-40	32538	
	2-1/8	5-1/2	M2632-44	32540	
		3	M2634-24	32542	
		4	M2634-32	32544	
		3	M2731-24	32550	
		3-1/2	M2731-28	32552	
1-11/16	1-15/16	4-1/2	M2732-28	32554	
		4	M2732-36	32556	
	2-1/16	3	M2733-24	32558	
		4	M2733-32	32562	
		4-1/2	M2733-36	32564	
		5-1/2	M2733-44	32568	
	2-3/16	2	M2735-16	32570	
		3	M2735-24	32574	
		4	M2735-32	32578	
	2-1/4	3	M2736-24	32586	
4-1/2		M2736-36	32588		
1-3/4	2	2-1/4	M2832-18	32590	
		2-1/2	M2832-20	32592	
		3	M2832-24	32594	
		4	M2832-32	32596	
		4-1/2	M2832-36	32598	
	2-1/16	5-1/4	M2832-42	32600	
		3-1/2	M2833-28	32602	
		2-3/4	M2834-22	32604	
	2-1/8	3-1/4	M2834-26	32606	
		3-1/2	M2834-28	32608	
		4	M2834-32	32610	
		4-1/4	M2834-34	32612	
		5	M2834-40	32614	
	1-13/16	2-1/4	1-3/4	M2836-14	32618
			2	M2836-16	32620
2-1/2			M2836-20	32622	
3			M2836-24	32624	
3-1/2			M2836-28	32626	
2-3/8		4	M2836-32	32628	
		4-1/4	M2836-34	32630	
		5	M2836-40	32632	
2-1/2		3-1/2	M2838-28	32634	
		5	M2838-40	32638	
2-1/2	6-1/2	M2840-52	32640		
2-3/16	4	M2935-32	32642		
1-7/8	2-5/16	4	M2937-32	32646	
		5	M2937-40	32648	
		2-1/2	M3034-20	32650	
	2-1/8	3	M3034-24	32652	
		4	M3034-32	32654	
		3	M3036-24	32656	
2-1/4	5	M3036-40	32662		
	3	M3038-24	32664		
	4	M3038-32	32666		
1-15/16	2-3/8	5-1/4	M3038-42	32668	
		2	M3135-16	32670	
	2-3/16	3	M3135-24	32672	
		3	M3136-24	32676	
	2-1/4	4-1/2	M3136-36	32678	
		3-1/2	M3137-28	32680	
	2-5/16	4	M3137-32	32682	
		5	M3137-40	32684	
		6-1/4	M3137-50	32688	
	2-3/8	4	M3138-32	32692	
		5-1/2	M3138-44	32694	
	2-7/16	3	M3139-24	32696	
3		M3140-24	32704		
2-1/2	5	M3140-40	32706		

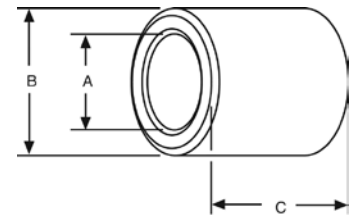

STANDARD TOLERANCES

DIMENSIONS	TOLERANCE
A	3/16 - 3 ±.001
B	3-1/4 - 4-1/2 ±.0015
C	5/16 - 3 +.002 to +.003 3-1/8 - 5 +.003 to +.005
	All ±.005

STANDARD CONCENTRICITY

DIMENSIONS	T.I.R. (A TO B)
A	All .003

For Oil Grooves see Page 179.

BEAR-N-BRONZE 660 Cast Bronze Bearings

Plain Cylindrical Bearings

F

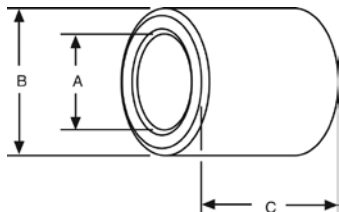

STANDARD TOLERANCES

DIMENSIONS		TOLERANCE
A	3/16 – 3	±.001
	3-1/4 – 4-1/2	±.0015
B	5/16 – 3	+.002 to +.003
	3-1/8 – 5	+.003 to +.005
C	All	±.005

STANDARD CONCENTRICITY

DIMENSIONS		T.I.R. (A TO B)
A	All	.003

For Oil Grooves see Page 179.

ALL DIMENSIONS IN INCHES
ORDER BY CATALOG NUMBER OR ITEM CODE

A	B	C	Catalog Number	Item Code	A	B	C	Catalog Number	Item Code		
2	2-1/4	2	M3236-16	32708	2-1/2	3-1/8	3-1/2	M4050-28	32860		
		2-1/2	M3236-20	32710			4	M4050-32	32862		
		3	M3236-24	32712			4-1/2	M4050-36	32864		
		3-1/2	M3236-28	32714		3-1/4	4	M4052-32	32868		
		4	M3236-32	32718			5	M4052-40	32870		
		4-1/2	M3236-36	32720			6	M4052-48	32872		
	2-3/8	3	M3238-24	32724	2-5/8	3-1/2	6-1/2	M4056-52	32876		
		3-1/2	M3238-28	32726			3	3	M4248-24	32878	
		4	M3238-32	32728				5	M4248-40	32882	
		4-1/2	M3238-36	32730		3-1/8		5	M4250-40	32884	
		2-1/2	M3240-20	32732			6	M4250-48	32886		
		3	M3240-24	32734			7-1/4	M4250-58	32888		
	2-1/2	3-1/2	M3240-28	32736	2-11/16	3-1/4	7	M4252-56	32890		
		4	M3240-32	32738			3-3/8	6-1/2	M4254-52	32892	
		4-1/2	M3240-36	32740				2-3/4	4	M4450-32	32900
		5	M3240-40	32742		5			M4450-40	32902	
		6	M3240-48	32746		6	M4450-48		32904		
		2-5/8	4	M3242-32		32748	2-7/8	3-1/4	4	M4452-32	32906
2-3/4	6-1/2	M3244-52	32750	5	M4452-40	32908					
2-1/2	3	M3440-24	32752	6	M4452-48	32910					
2-1/8	4	M3440-32	32754	2-7/8	3-1/2	4		M4656-36	32926		
	4	M3442-32	32756			6-3/4		M4656-54	32928		
	5	M3442-40	32758			2-15/16		3-1/2	M4755-28	32930	
	6	M3442-48	32760		5		M4755-40	32932			
	2-5/8	4	M3542-32		32762		6-1/2	M4755-52	32934		
	2-3/16	5	M3542-40		32764	3	3-3/8	4-1/2	M4854-36	32936	
3-1/2		M3543-28	32766	8	M4854-64			32938			
4-1/2		M3543-36	32770	3-1/2	4-1/2			M4856-36	32940		
5		M3543-40	32772		6		M4856-48	32942			
2-3/4		4-1/2	M3544-36		32774		9	M4856-72	32944		
2-1/4		5-1/4	M3544-42	32776	3-1/4		3-1/2	5	M4858-40	32946	
	6	M3544-48	32778	3-3/4		6-1/4		M4860-50	32952		
	2-7/8	4-1/2	M3546-36	32780		4		6-1/2	M4864-52	32954	
	2-1/2	3-1/2	M3640-28	32782		3-7/16	3-15/16	4-1/2	M5563-36	32964	
		4	M3640-32	32784				6-1/2	M5563-52	32966	
		3	M3642-24	32786				3-1/2	4	M5664-44	32968
4		M3642-32	32788	7	M5664-56		32970				
5		M3642-40	32790	4-1/8	6		M5666-48		32972		
2-11/16		4-3/4	M3643-38		32792		4-1/4	4-1/2	M5668-36	32974	
3-1/2	M3644-28	32794	7		M5668-56	32976					
2-3/8	4	M3644-32	32796	4	4-1/2	9-3/4		M5668-78	32978		
	4-1/2	M3644-36	32798			4-1/4	5	M6068-40	32980		
	5	M3644-40	32800				7	M6068-56	32982		
	6	M3644-48	32802		4-1/2		6-1/2	M6072-52	32984		
	3	M3648-28	32806			4	4	M6472-32	32986		
	5	M3648-40	32808				6	M6472-48	32988		
2-3/4	4	M3844-32	32812	4-1/4	4-3/4		7	M6472-56	32990		
	6	M3844-48	32816			5	M6480-40	32992			
	2-7/8	4	M3846-32			32818	6	M6480-48	32994		
	5	M3846-40	32820		5	5	M6876-40	32998			
	2-7/16	2-3/4	4			M3944-32	32824	5	6	M6876-48	33000
		5	M3944-40			32826	7		M6876-56	33002	
2-7/8		3	M3946-24	32828	4-1/4	5	M6880-40		33004		
2-1/2		5	M3946-40	32830		5	6	M6880-48	33006		
		4	M3947-32	32832			7	M6880-56	33008		
		5	M3947-40	32834	4-1/2		6	M7280-48	33010		
	6-1/4	M3947-50	32836	7		M7280-56	33012				
	3-3/4	3	M3948-30	32838		8	M7280-64	33014			
	5	M3948-40	32840	2-1/2	3	6	M4044-32	32844			
6-1/4	5	M3948-50	32842			7	M4044-40	32846			
2-3/4	4	M4044-32	32844			2-7/8	3-1/4	M4046-26	32848		
2-1/2	5	M4044-40	32846				4-1/2	M4046-36	32850		
	4	M4048-32	32852				5	4	M4048-32	32852	
	5	M4048-40	32854			5		M4048-40	32854		
	6	M4048-48	32856	6	M4048-48	32856					
	7	M4048-56	32858	7	M4048-56	32858					

BEAR-N-BRONZE 660 Cast Bronze Bearings

Cored Bars

ALL DIMENSIONS IN INCHES
ORDER BY CATALOG NUMBER OR ITEM CODE

A	B	Aprx. Wgt. (Lbs.)	Catalog Number	Item Code	
1/2	1	2-3/4	MCB816	33016	
	1-1/8	3-3/4	MCB818	33018	
	1-1/4	4-3/4	MCB820	33020	
	1-1/2	7	MCB824	33024	
	1-3/4	9-3/4	MCB828	33026	
	2	12-3/4	MCB832	33028	
5/8	1	2	MCB1016	47640	
	1-1/8	3	MCB1018	33030	
	1-1/4	4	MCB1020	33032	
	1-3/8	5	MCB1022	33034	
	1-1/2	6-1/2	MCB1024	33036	
	1-3/4	9	MCB1028	33040	
3/4	1	1-1/2	MCB1216	47641	
	1-1/8	2-1/2	MCB1218	47642	
	1-1/4	3-1/2	MCB1220	33046	
	1-3/8	4-1/2	MCB1222	33048	
	1-1/2	5-1/2	MCB1224	33050	
	1-3/4	8	MCB1228	33054	
	2	11-1/2	MCB1232	33058	
	2-1/4	15	MCB1236	33062	
	2-1/2	19-1/2	MCB1240	33064	
	2-3/4	24	MCB1244	33066	
7/8	1-1/8	1-7/8	MCB1418	47643	
	1-1/4	2-7/8	MCB1420	47644	
	1-3/8	4	MCB1422	33068	
	1-1/2	5	MCB1424	33070	
	1-5/8	6-1/2	MCB1426	33072	
	1-3/4	7-1/2	MCB1428	33074	
	2	11	MCB1432	33078	
1	1-1/4	2	MCB1620	47645	
	1-3/8	3-1/8	MCB1622	47646	
	1-1/2	4-1/2	MCB1624	33084	
	1-5/8	5-1/2	MCB1626	33086	
	1-3/4	7	MCB1628	33088	
	1-7/8	8-1/2	MCB1630	33090	
	2	10	MCB1632	33092	
	2-1/4	13-1/2	MCB1636	33096	
	2-1/2	17-1/2	MCB1640	33100	
	2-3/4	22	MCB1644	33102	
		3	27	MCB1648	33104
	2-1/4	32	MCB1652	33106	
	3-1/2	37-1/2	MCB1656	33108	
	4	50	MCB1664	33110	

A	B	Aprx. Wgt. (Lbs.)	Catalog Number	Item Code
1-1/8	1-3/8	2-1/4	MCB1822	47647
	1-1/2	4-1/2	MCB1824	47648
	1-5/8	5	MCB1826	33112
	2-1/8	11-1/2	MCB1834	33120
	2-1/2	16-1/2	MCB1840	33126
1-1/4	1-1/2	2-1/2	MCB2024	47649
	1-5/8	3-7/8	MCB2026	47650
	1-3/4	5-1/2	MCB2028	33132
	1-7/8	7	MCB2030	33134
	2	8-1/2	MCB2032	33136
	2-1/8	10-1/2	MCB2034	33138
	2-1/4	12	MCB2036	33140
	2-1/2	16	MCB2040	33144
	2-3/4	20	MCB2044	33148
	3	25	MCB2048	33152
1-3/8	3-1/4	30	MCB2052	33154
	3-1/2	35-1/2	MCB2056	33156
	1-3/4	4-1/4	MCB2228	47652
	1-7/8	6	MCB2230	33160
	2	7-1/2	MCB2232	33162
1-1/2	2-1/8	9-1/2	MCB2234	33164
	2-1/4	11	MCB2236	33166
	2-3/8	12-1/2	MCB2238	33168
	1-3/4	3	MCB2428	47653
	1-7/8	4-1/2	MCB2430	47654
	2	6	MCB2432	33178
	2-1/8	8	MCB2434	33180
	2-1/4	10	MCB2436	33182
	2-3/8	11-1/2	MCB2438	33184
	2-1/2	14	MCB2440	33186
	2-3/4	18	MCB2444	33190
	3-1/4	27-1/2	MCB2452	33194
	3-1/2	33	MCB2456	33196
	3-3/4	40	MCB2460	33198
	4	45	MCB2464	33200
	4-1/2	62	MCB2472	33202

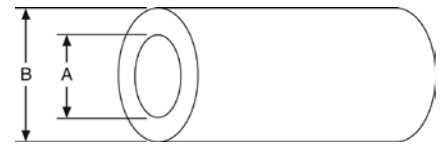
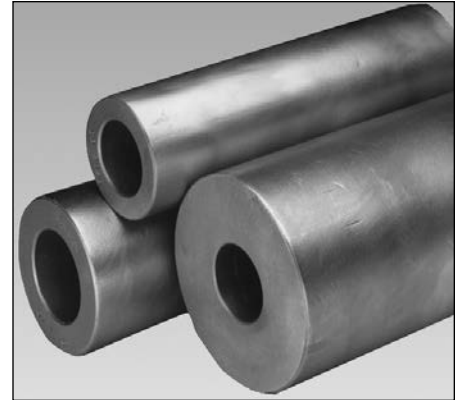

STANDARD TOLERANCES

DIMENSIONS	TOLERANCE
A	1/2 - 4 4-1/4 - 8
B	1 - 4 4-1/4 - 9

All bars are 13" long.
Contact factory for bars longer than 13". Available in lengths up to 105".

BEAR-N-BRONZE 660 Cast Bronze Bearings

Cored Bars

F

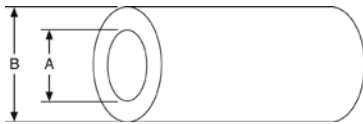

STANDARD TOLERANCES

DIMENSIONS		TOLERANCE
A	1/2 – 4	- 1/16
	4-1/4 – 8	- 1/8
B	1 – 4	+ 1/16
	4-1/4 – 9	+ 1/8

ALL DIMENSIONS IN INCHES ORDER BY CATALOG NUMBER OR ITEM CODE

A	B	Aprx. Wgt. (Lbs.)	Catalog Number	Item Code	A	B	Aprx. Wgt. (Lbs.)	Catalog Number	Item Code		
1-5/8	2	4-7/8	MCB2632	47655	2-3/8	3	12	MCB3848	33314		
	2-1/8	7	MCB2634	33204		3	9-7/8	13	MCB4048	47661	
	2-1/4	9	MCB2636	33206			3-1/8	15	13	MCB4050	33324
	2-3/8	10-1/2	MCB2638	33208				3-1/4	21	15	MCB4052
1-3/4	2	3-3/8	MCB2832	47656	3-1/2				27	21	MCB4056
	2-1/8	5-1/8	MCB2834	47657		4			33-1/2	27	MCB4060
	2-1/4	7-1/2	MCB2836	33218			4-1/4		40	33-1/2	MCB4064
	2-3/8	9	MCB2838	33220				4-1/2	46	40	MCB4068
	2-1/2	11	MCB2840	33222	5				61	46	MCB4072
	2-5/8	13-1/2	MCB2842	33224		5-1/2			78	61	MCB4080
	2-3/4	15-1/2	MCB2844	33226			2-3/4		19-1/2	78	MCB4088
	3	20	MCB2848	33230				3-1/2	22-1/2	19-1/2	MCB4456
	3-1/4	25	MCB2852	33232	3-3/4				28-1/2	22-1/2	MCB4460
	3-1/2	31	MCB2856	33234		4			35	28-1/2	MCB4464
4	42-1/2	MCB2864	33238	4-1/4			42		35	MCB4468	33358
4-1/4	50	MCB2868	33240				4-1/2	26-3/4	42	MCB4472	33360
1-7/8	2-1/4	5-1/2	MCB3036		47658			2-7/8	4	26-3/4	MCB4664
	2-3/8	7-1/2	MCB3038		33242	3			3-1/2	11-1/2	MCB4856
	2-1/2	9-3/4	MCB3040	33244	3-3/4				18-1/4	11-1/2	MCB4860
	2-5/8	12	MCB3042	33246			4		24-1/2	18-1/4	MCB4864
2	2-1/4	3-7/8	MCB3236	47659				4-1/4	31	24-1/2	MCB4868
	2-1/2	8-1/2	MCB3240	33256		4-1/2			38	31	MCB4872
	2-5/8	10	MCB3242	33258	4-3/4				45	38	MCB4876
	2-3/4	12-1/4	MCB3244	33260			5		52	45	MCB4880
	3	16-1/2	MCB3248	33264				5-1/2	70	52	MCB4888
	3-1/4	22	MCB3252	33266		6			89-1/2	70	MCB4896
	3-1/2	29	MCB3256	33268	6-1/2				110	89-1/2	MCB48104
	3-3/4	34	MCB3260	33270			3-1/4		19-1/2	110	MCB5264
	4	39-1/2	MCB3264	33272				4-1/4	25-1/2	19-1/2	MCB5268
	4-1/2	54	MCB3272	33274		4-1/2			34	25-1/2	MCB5272
5	69	MCB3280	33276	5	48				34	MCB5280	33390
6	105-1/2	MCB3296	33278		4-1/4		20-7/8		48	MCB5668	47665
2-1/8	2-5/8	8-1/2	MCB3442				33280	4-1/2	30	20-7/8	MCB5672
	2-7/8	13	MCB3446			33284	4-3/4		35-1/2	30	MCB5676
2-1/4	2-3/4	9	MCB3644	33294		5			44	35-1/2	MCB5680
	3-1/4	19	MCB3652	33302	5-1/2				61	44	MCB5688
	3-1/2	25	MCB3656	33304				6	79	61	MCB5688
	3-3/4	30-1/2	MCB3660	33306			6-1/2		107-1/2	79	MCB5696
	4	37	MCB3664	33308		107-1/2			22-1/4	107-1/2	MCB56104
	4-1/4	43	MCB3668	33310	3-3/4				29	22-1/4	MCB6072
2-1/4	2-3/4	9	MCB3644	33294				4-3/4	38	29	MCB6076
	3-1/4	19	MCB3652	33302			5		38	38	MCB6080
	3-1/2	25	MCB3656	33304		6			74	38	MCB6096
	3-3/4	30-1/2	MCB3660	33306	6				74	74	MCB6096

All bars are 13" long.
Contact factory for bars longer than 13".

BEAR-N-BRONZE 660 Cast Bronze Bearings

Cored Bars

ALL DIMENSIONS IN INCHES
ORDER BY CATALOG NUMBER OR ITEM CODE

A	B	Aprx. Wgt. (Lb.)	Catalog Number	Item Code	Aprx. A	B	Wgt. (Lb.)	Catalog Number	Item Code	
4	4-3/4	22-3/4	MCB6476	47668	5-1/4	7	77	MCB84112	47675	
	5	32-1/4	MCB6480	47669	5-1/2	6-1/2	43	MCB88104	47676	
	5-1/2	49	MCB6488	33412		7	67-1/4	MCB88112	47677	
	6	67-1/2	MCB6496	33414		7-1/2	91	MCB88120	33434	
	4-1/4	6-1/2	87	MCB64104	33416	8	113	MCB88128	33436	
		7	109	MCB64112	33510	5-3/4	7-1/2	79	MCB92120	33438
		7-1/2	134	MCB64120	33512		6	7	46-1/2	MCB96112
6		61	MCB6896	33418	7-1/2			72-1/2	MCB96120	47679
6-1/2	82	MCB68104	33514	8	94	MCB96128		33440		
4-1/2	5-1/2	36	MCB7288	47671	9	151	MCB96144	33522		
	6	56-1/2	MCB7296	47672	6-1/2	7-1/2	50-1/4	MCB104120	47681	
	6-1/2	75	MCB72104	33420		8	84	MCB104128	47682	
7	97	MCB72112	33422	9		130	MCB104144	33442		
4-3/4	6	67	MCB7696	47673	8	9	61	MCB128144	47684	
5	6	39	MCB8096	33428						
	7	81	MCB80112	33430						
	7-1/2	104	MCB80120	33516						
	8	130	MCB80128	33518						

All bars are 13" long.
Contact factory for bars longer than 13".

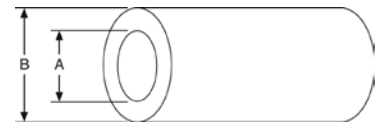

STANDARD TOLERANCES

DIMENSIONS	TOLERANCE
A	1/2 - 4 4-1/4 - 8
B	1 - 4 4-1/4 - 9

Solid Bars

ALL DIMENSIONS IN INCHES
ORDER BY CATALOG NUMBER OR ITEM CODE

B	Aprx. Wgt. (Lb.)	Catalog Number	Item Code	B	Aprx. Wgt. (Lb.)	Catalog Number	Item Code
1/2	1	MS8	33444	3	30	MS48	33484
5/8	1-1/2	MS10	33446	3-1/4	35-1/2	MS52	33486
3/4	2	MS12	33448	3-1/2	41	MS56	33488
7/8	2-3/4	MS14	33450	4	53	MS64	33492
1	3-1/2	MS16	33452	4-1/4	59	MS68	33494
1-1/8	4-1/2	MS18	33454	4-1/2	67	MS72	33496
1-1/4	5-1/2	MS20	33456	4-3/4	73	MS76	33536
1-3/8	6-1/2	MS22	33458	5	82	MS80	33498
1-1/2	7-1/2	MS24	33460	5-1/2	98	MS88	33500
1-5/8	8-1/2	MS26	33462	6	118	MS96	33502
1-3/4	10-1/4	MS28	33464	6-1/2	139	MS104	33538
1-7/8	11-1/2	MS30	33466	7	161	MS112	33504
2	14	MS32	33468	7-1/2	186	MS120	33506
2-1/4	17	MS36	33472	8	210-1/2	MS128	33508
2-1/2	21-1/2	MS40	33476	9	273	MS144	33544
2-5/8	23-1/2	MS42	33478				
2-3/4	25-1/2	MS44	33480				

All Bars are 13" long.
Contact Factory for Bars longer than 13".

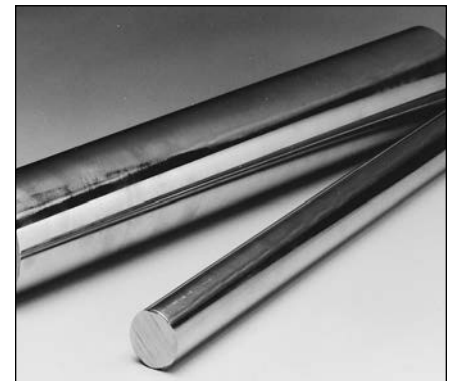

STANDARD TOLERANCES

DIMENSIONS	TOLERANCE
B	1/2 - 4 4-1/4 - 9

Bronze Bearing Emergency Banks

F



Actual Size of Bank 10-1/2 x 13-1/2"

SAVES MONEY — Reduce time lost when breakdowns occur due to bearing failures. You own stock — any time — day or night.

COMPACT — Handy metal kit keeps bearings together in conveniently labeled compartments. Bearings where you want them — when you need them.

REFILLS AVAILABLE — Both kit and replacement bearings are available from stock.

See your Boston Gear Distributors, in all major cities — from coast to coast.

BOST-BRONZ Emergency Bank

Order by Catalog Number-34500 BBB-1

There are two each of the 47 bearing sizes below in the bank.

B46-8	1/4 x 3/8 x 1	B913-12	9/16 x 13/16 x 1-1/2	B1618-16	1 x 1-1/8 x 2
B47-8	1/4 x 7/16 x 1	B1012-12	5/8 x 3/4 x 1-1/2	B1620-20	1 x 1-1/4 x 3
B48-8	1/4 x 1/2 x 1	B1013-16	5/8 x 13/16 x 2	B1622-24	1 x 1-3/8 x 3
B56-8	5/16 x 3/8 x 1	B1014-16	5/8 x 7/8 x 2	B1624-16	1 x 1-1/2 x 2
B58-8	5/16 x 1/2 x 1	B1016-16	5/8 x 1 x 2	B1721-20	1-1/16 x 1-5/16 x 2-1/2
B68-10	3/8 x 1/2 x 1-1/4	B1114-16	11/16 x 7/8 x 2	B1822-24	1-1/8 x 1-3/8 x 3
B69-10	3/8 x 9/16 x 1-1/4	B1214-12	3/4 x 7/8 x 1-1/2	B1824-16	1-1/8 x 1-1/2 x 2
B610-10	3/8 x 5/8 x 1-1/4	B1215-16	3/4 x 15/16 x 2	B1923-24	1-3/16 x 1-7/16 x 3
B79-10	7/16 x 9/16 x 1-1/4	B1216-20	3/4 x 1 x 2-1/2	B1924-24	1-3/16 x 1-1/2 x 3
B710-10	7/16 x 5/8 x 1-1/4	B1218-16	3/4 x 1-1/8 x 2	B2024-24	1-1/4 x 1-1/2 x 3
B711-12	7/16 x 11/16 x 1-1/2	B1316-16	13/16 x 1 x 2	B2026-16	1-1/4 x 1-5/8 x 2
B810-12	1/2 x 5/8 x 1-1/2	B1416-12	7/8 x 1 x 1-1/2	B2126-24	1-5/16 x 1-5/8 x 3
B812-16	1/2 x 3/4 x 2	B1418-20	7/8 x 1-1/8 x 2-1/2	B2228-16	1-3/8 x 1-3/4 x 2
B813-12	1/2 x 13/16 x 1-1/2	B1420-16	7/8 x 1-1/4 x 2	B2328-24	1-7/16 x 1-3/4 x 3
B814-12	1/2 x 7/8 x 1-1/2	B1519-16	15/16 x 1-3/16 x 2	B2430-16	1-1/2 x 1-7/8 x 2
B912-12	9/16 x 3/4 x 1-1/2	B1520-16	15/16 x 1-1/4 x 3		

BEAR-N-BRONZ Emergency Bearing Bank

Order by Item Code

Bank #1 Item Code – 31300

Bank #2 Item Code – 31304

Bank #1		Bank #2			
<i>There are two each of the 30 bearing sizes below in the bank.</i>		<i>There are two each of the 20 bearing sizes below in the bank.</i>			
M46-10	1/4 x 3/8 x 1-1/4	M1824-16	1-1/8 x 1-1/2 x 2	M1219-12	3/4 x 1-3/16 x 1-1/2
M58-10	5/16 x 1/2 x 1-1/4	M1923-16	1-3/16 x 1-7/16 x 2	M1318-12	13/16 x 1-1/8 x 1-1/2
M69-10	3/8 x 9/16 x 1-1/4	M1926-16	1-3/16 x 1-5/8 x 2	M1419-8	7/8 x 1-3/16 x 1
M710-10	7/16 x 5/8 x 1-1/4	M2026-20	1-1/4 x 1-5/8 x 2-1/2	M1420-12	7/8 x 1-1/4 x 1-1/2
M812-12	1/2 x 3/4 x 1-1/2	M2228-18	1-3/8 x 1-3/4 x 2-1/4	M1620-16	1 x 1-1/4 x 2
M816-16	1/2 x 1 x 2	M2230-24	1-3/8 x 1-7/8 x 3	M1624-16	1 x 1-1/2 x 2
M912-12	9/16 x 3/4 x 1-1/2	M2328-24	1-7/16 x 1-3/4 x 3	M1824-16	1-1/8 x 1-1/2 x 2
M1014-12	5/8 x 7/8 x 1-1/2	M2330-32	1-7/16 x 1-7/8 x 4	M1923-16	1-3/16 x 1-7/16 x 2
M1115-12	11/16 x 15/16 x 1-1/2	M2428-18	1-1/2 x 1-3/4 x 2-1/4	M2028-16	1-1/4 x 1-3/4 x 2
M1216-12	3/4 x 1 x 1-1/2	M2430-20	1-1/2 x 1-7/8 x 2-1/2	M2126-16	1-5/16 x 1-5/8 x 2
M1316-12	13/16 x 1 x 1-1/2	M2432-28	1-1/2 x 2 x 3-1/2	M2228-16	1-3/8 x 1-3/4 x 2
M1420-14	7/8 x 1-1/4 x 1-3/4	M2630-30	1-5/8 x 1-7/8 x 3-3/4	M2330-24	1-7/16 x 1-7/8 x 3
M1520-20	15/16 x 1-1/4 x 2-1/2	M2632-24	1-5/8 x 2 x 2	M2428-18	1-1/2 x 1-3/4 x 2-1/4
M1620-16	1 x 1-1/4 x 2	M2832-32	1-3/4 x 2 x 4	M2430-20	1-1/2 x 1-7/8 x 2-1/2
M1624-16	1 x 1-1/2 x 2			M2432-20	1-1/2 x 2 x 2-1/2
M1723-20	1-1/16 x 1-7/16 x 2-1/2			M2630-18	1-5/8 x 1-7/8 x 2-1/4
				M2632-24	1-5/8 x 2 x 3
				M2832-24	1-3/4 x 2 x 3
				M3238-32	2 x 2-3/8 x 4
				M3644-32	2-1/4 x 2-3/4 x 4

BOSStonE F-1 Glass Filled Teflon Bearings

F



BOSStonE F-1 glass filled material is completely self-lubricating with outstanding wear and corrosion resistance properties, machined from extruded rods to close tolerances. BOSStonE F-1 material has a wide temperature capability and an excellent PV value. **BOSStonE F-1 bearings may be green, white or any other color.**

Lubrication of these bearings is not required. Teflon®, the major ingredient of BOSStonE F-1 material (75% to 80%), has excellent self-lubricating characteristics and a low coefficient of friction. The remaining 20% to 25% is glass.

BOSStonE F-1 bearing material has excellent strength and wearability and was developed to withstand high loads at moderate speeds. The allowable operating temperature range is -400° to +550°F.

Typical applications for BOSStonE F-1 bearings are textile machinery, farm implements, food processing equipment, pulp and paper machinery, business machinery, aircraft, home appliances, automotive and machine tools as well as many others, in both the electrical and chemical fields.

Cylindrical, Flanged and Thrust Bearings and Solid Bars are stocked in BOSStonE F-1 material.

Selection

In general, sleeve bearings should be selected with a length of one to two times the shaft diameter and an O.D. approximately 25% larger than the shaft diameter.

A general guide to determination of limiting load and velocity values for sleeve bearings has been established by the use of PV calculations. PV represents Pressure x Velocity, for example 100 psi x 20 fpm yields a PV of 2000.

Maximum PV value for BOSStonE F-1 bearings: 20,000 (50,000 for intermittent service).

For complete selection and application information, see Engineering Section, Pages 174-182.

BOSStonE F-1 Glass Filled Teflon Bearings

Plain Cylindrical Bearings

F

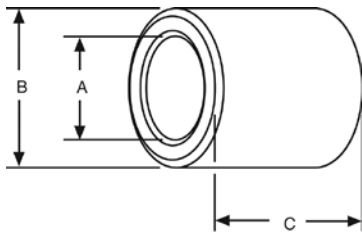

ALL DIMENSIONS IN INCHES
ORDER BY CATALOG NUMBER OR ITEM CODE

A	B	C	Catalog Number	Item Code	A	B	C	Catalog Number	Item Code
3/16 .191	5/16 .313	1/4	P35-2	56821	3/4 .755	1 1.001	1/2	P1216-4	56845
		3/8	P35-3	56822			3/4	P1216-6	56846
		1/2	P35-4	56823			1	P1216-8	56847
1/4 .254	3/8 .376	1/4	P46-2	56824	7/8 .880	1-1/8 1.126	3/4	P1418-6	56848
		3/8	P46-3	56825			1	P1418-8	56849
		1/2	P46-4	56826					
5/16 .316	1/2 .501	3/8	P58-3	56827	1 1.005	1-1/4 1.251	3/4	P1620-6	56850
		1/2	P58-4	56828			1	P1620-8	56851
3/8 .379	9/16 .563	3/8	P69-3	56829	1-1/8 1.130	1-3/8 1.376	3/4	P1822-6	56853
		1/2	P69-4	56830			1	P1822-8	56854
		3/4	P69-6	56831			1-1/2	P1822-12	56855
7/16 .441	5/8 .626	3/8	P710-3	56832	1-1/4 1.255	1-1/2 1.501	3/4	P2024-6	56856
		1/2	P710-4	56833			1	P2024-8	56857
		3/4	P710-6	56834			1-1/2	P2024-12	56858
1/2 .504	3/4 .751	1/2	P812-4	56835	1.380	1.626	1-1/2	P2226-12	56860
		3/4	P812-6	56836			1	P2428-8	56861
		1	P812-8	56837			1-1/2	P2428-12	56862
5/8 .630	7/8 .876	5/8	P1014-5	56841	1-5/8 1.631	1-7/8 1.876	2	P2428-16	56863
		3/4	P1014-6	56842					
		1	P1014-8	56843					
11/16 .693	15/16 .938	3/4	P1115-6	56844	1-3/4 1.756	2 2.001	1-3/4	P2832-14	56865
1-7/8 1.881	2-1/8 2.126				2 2.006	2-1/4 2.251	2	P3034-16	56866
							2	P3236-16	56867

On A and B dimensions, tolerances apply to actual (decimal) dimensions

STANDARD TOLERANCES

DIMENSIONS	TOLERANCE
A B	All +.002 to -.000
C	All ±.005

STANDARD CONCENTRICITY

DIMENSIONS	T.I.R. (A TO B)
A .129 – 1.005	.003
A 1.130 – 2.006	.004

Flanged Bearings

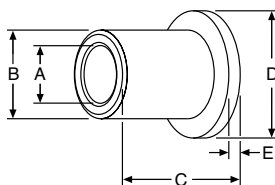
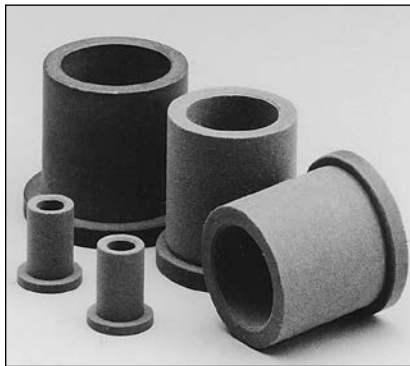

ALL DIMENSIONS IN INCHES
ORDER BY CATALOG NUMBER OR ITEM CODE

A	B	C	D	E	Catalog Number	Item Code
3/16 .191	5/16 .313	1/4	.437	1/16	FP35-2	56868
		1/2			FP35-4	56869
1/4 .254	3/8 .376	3/8	.500	1/16	FP46-3	56870
		1/2			FP46-4	56871
3/8 .379	5/8 .626	1/2	.875	1/8	FP610-4	56872
		3/4			FP610-6	56873
1/2 .504	3/4 .751	1/2	1.000	1/8	FP812-4	56874
		3/4			FP812-6	56875
		1			FP812-8	56876
5/8 .630	7/8 .876	3/4	1.000	1/8	FP1014-6	56877
		1			FP1014-8	56878
3/4 .755	1 1.001	1	1.250	1/8	FP1216-8	56879

On A and B dimensions, tolerances apply to actual (decimal) dimensions

STANDARD TOLERANCES

DIMENSIONS	TOLERANCE
A B	All +.002 to -.000
C	All ±.005
D	All ±.005
E	All ±.003

STANDARD CONCENTRICITY

DIMENSIONS	T.I.R. (A TO B)
A All	.003

BOSStonE F-1 Glass Filled Teflon Bearings

Thrust Type

ALL DIMENSIONS IN INCHES
ORDER BY CATALOG NUMBER OR ITEM CODE

A	B	C	Catalog Number	Item Code
1/4 .254	5/8 .625	.060	TP410	56880
3/8 .379	3/4 .750	.060	TP612	56881
1/2 .504	1 1.000	.060	TP816	56882

On A and B dimensions, tolerances apply to actual (decimal) dimensions.



STANDARD TOLERANCES

DIMENSIONS	TOLERANCE
A	All +.010 / -.000
B	All +.000 / -.010
C	All +.004 / -.000
E	All +.004 / -.000

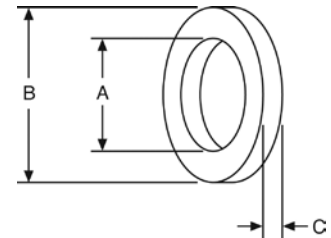

ALL DIMENSIONS IN INCHES
ORDER BY CATALOG NUMBER OR ITEM CODE

B	Approx. Weight (In Lbs.)	Catalog Number	Item Code
1/4	.065	SP4	50958
3/8	.135	SP6	50959
1/2	.233	SP8	50960
1	.878	SP16	50962
1-1/4	1.355	SP20	50963
1-1/2	1.937	SP24	50964
2	3.250	SP32	50965

All Bars are 13" long.
Other Diameters and longer Lengths are available on special order.

Solid Bars (Extruded)



STANDARD TOLERANCES

DIMENSIONS	TOLERANCE
B	1/4 - 1/2 -.000 to +.015
	3/4 - 1 -.000 to +.020
	1-1/4 -.000 to +.030
	1-1/2 - 2 -.000 to +.040



Other BOSStonE F-1 SHAPES AVAILABLE ON SPECIAL ORDER



CORED BARS



CIRCULAR DISCS



TUBING



PLATES

RULON® 641 Bearings

F



Boston Gear's RULON 641 Bearings are designed to overcome the chronic problems that plague bearings used in food and pharmaceutical applications.

Features

- FDA cleared, USDA accepted non-toxic materials
- RULON 641 compound of virgin PTFE and fillers designed to meet poultry and meat industry specs
- FDA drug master file numbered to allow for incidental contact with body fluids
- Excellent load and wear characteristics for continuous non-lubricated service
- Compatible with food and drug industries standard stainless steels 303 and 316 as well as 1018 mild steel
- Designed for performance at extremely high temperatures. PV value of 10,000 with 316 stainless steel
- Capable of speeds up to 400 ft/minute under dry, low-load operation
- Stick-slip is virtually nonexistent due to low friction at start-up and slow speeds. Ideal for oscillating or start/stop applications
- Corrosion resistant, unaffected by all common acids, bases, and solvents
- Shatter proof design to eliminate sudden breakdowns

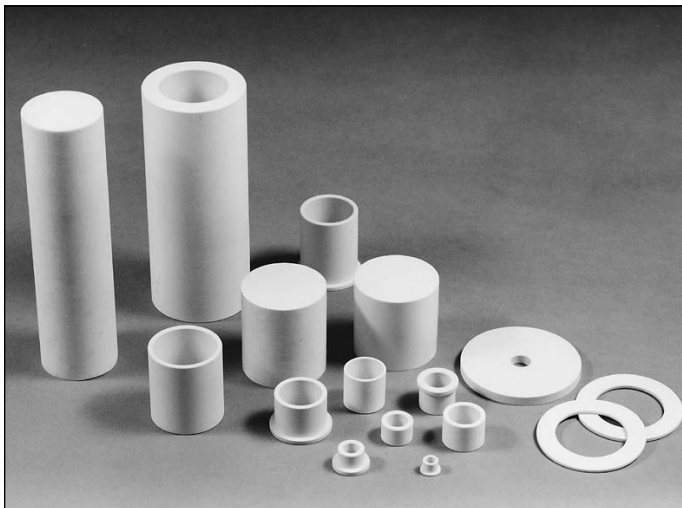

Why RULON 641 for Food and Pharmaceutical Applications

- White natural color and lower friction than when using carbon bearings
- No metallic debris to drop into a process such as when using bronze bearings
- No leaky lubricants or lubricants damaged by high or low temperatures or cleaning solutions such as when using bronze bearings
- RULON 641 has a wider temperature tolerance and better load carrying capabilities than UHMWPE materials
- RULON 641 has better wear properties and better high temperature load carrying capabilities than virgin PTFE alone
- Reduced downtime
- No lubrication required



Applications

RULON 641 bearings are perfect for use in machinery and equipment in the following areas:

- Prepared meat products
- Frozen foods
- Cookies and crackers
- Candy
- Animal and marine fats and oils
- Malt beverages
- Medicinal chemicals
- Pharmaceutical preparations
- Soaps and detergents
- Perfumes and cosmetics
- Food-related packing and sealing devices
- Food and drug conveyors
- Coffee
- Food preparations
- Biological products
- Food process machinery
- Vending machines
- Household cooking equipment and appliances

Recommended Operating Limits	RULON 641	Engineering Information	RULON 641
Temperature — Typical Range °F	- 400/+500	Friction—Static & Dynamic	.10-.30
Maximum PV (continuous)	10,000	Water Absorption ASTM D570	0%
Maximum P — PSI (static)	1,000	Flammability ASTM D635	Non-Flammable
Maximum V — SFM (no load)	400	Chemical Resistance	Inert
Shaft Hardness — Minimum	RB25	Thermal Conductivity BTU/hr/sq. ft/°F/in.	2.60
Shaft Finish Recommended RMS	8 – 16	Linear Coefficient of 78°F–200°F	^B 3.9 x 10 ⁻⁵
	Mild Steel, 303	Thermal Expansion	^C 4.9 x 10 ⁻⁵
	+316 Stainless Steel	(-78°F)–(350°F)	^B 4.2 x 10 ⁻⁵
			^C 5.7 x 10 ⁻⁵

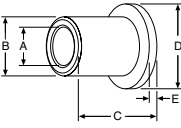
Note: B = Bearing Diameter C = Bearing Length

SLEEVE BEARINGS							FLANGED BEARINGS																							
A -.000 +.002 ID	B -.000 +.002 OD	Recommended Housing Bore*	Recommended Shaft Size	C ±.005	Catalog Number	Item Code	A -.000 +.002	B -.000 +.002	Recommended Housing Bore*	Recommended Shaft Size	C Lgth. ±.005	Flange D ±.005 E ±.003		Catalog Number	Item Code															
1/4 .254	3/8 .376	.375/.374	.2500/.2490	.250 .375	RP46-2 RP46-3	56790 56791	1/4 .254	3/8 .376	.375/.374	.2500/.2490	.500	.500	.062	RFP46-4	56802															
3/8 .379	9/16 .563	.562/.561	.3750/.3740	.375	RP69-3	56792	3/8 .379	5/8 .626	.625/.624	.3750/.3740	.500	.875	.125	RFP610-4	56803															
1/2 .504	3/4 .751	.750/.749	.5000/.4990	.500	RP812-4	56793	1/2 .504	3/4 .751	.750/.749	.5000/.4990	1.000	1.000	.125	RFP812-8	56804															
5/8 .630	7/8 .876	.875/.874	.6250/.6240	.625	RP1014-5 RP1014-8	56794 56795	5/8 .630	7/8 .876	.875/.874	.6250/.6240	1.000	1.000	.125	RFP1014-8	56805															
3/4 .755	1 1.001	1.000/.999	.7500/.7490	.750 1.500	RP1216-6 RP1216-12	56796 56797	3/4 .755	1 1.001	1.000/.999	.7500/.7490	1.000	1.250	.125	RFP1216-8	56817															
1 1.005	1-1/4 1.251	1.250/1.249	1.000/.9990	1.000 1.500	RP1620-8 RP1620-12	56798 56799	 																							
1-1/4 1.255	1-1/2 1.501	1.500/1.499	1.250/1.249	2.000	RP2024-16	56800																								
1-1/2 1.506	1-3/4 1.751	1.750/1.749	1.500/1.499	2.000	RP2428-16	56801																								
 																														
<p>Other Shapes Available On Special Order</p>  <p>PLATES</p>  <p>CORED BARS</p>							<p>SOLID BARS</p> <table border="1"> <thead> <tr> <th>B (Dia.)</th> <th>Standard Tolerances</th> <th>Approx. Wt. Lbs.</th> <th>Catalog Number</th> <th>Item Code</th> </tr> </thead> <tbody> <tr> <td>1/2 .504</td> <td>-.000/+.015</td> <td>.233</td> <td>RSP-8</td> <td>56786</td> </tr> <tr> <td>3/4 .755</td> <td>-.000/+.015</td> <td>.503</td> <td>RSP-12</td> <td>56787</td> </tr> <tr> <td>1 1.005</td> <td>-.000/+.020</td> <td>.878</td> <td>RSP-16</td> <td>56788</td> </tr> </tbody> </table> <p>All Bars are 13" long Other Diameters and longer lengths are available on special order.</p> 				B (Dia.)	Standard Tolerances	Approx. Wt. Lbs.	Catalog Number	Item Code	1/2 .504	-.000/+.015	.233	RSP-8	56786	3/4 .755	-.000/+.015	.503	RSP-12	56787	1 1.005	-.000/+.020	.878	RSP-16	56788
B (Dia.)	Standard Tolerances	Approx. Wt. Lbs.	Catalog Number	Item Code																										
1/2 .504	-.000/+.015	.233	RSP-8	56786																										
3/4 .755	-.000/+.015	.503	RSP-12	56787																										
1 1.005	-.000/+.020	.878	RSP-16	56788																										

*Press fit. .004/.001 Note: On A and B dimensions, tolerances apply to actual (decimal) dimensions.

BOSStonE Molded Plastic Bearings

F



Boston stocks Cylindrical, Flanged and Roll End Bearings in five materials —

1. Nylon (N) exhibits good chemical and corrosion resistance. Excellent abrasion resistance and low surface friction provide long wear without lubrication. These nylon bearings are black. Good up to 225°F maximum.
2. Delrin® and Celcon® (D) are trademarks for equivalent Acetal Resins produced by Du Pont and Celanese respectively. Acetals possess excellent moisture resistance characteristics. These materials are white. Good up to 225°F maximum.
3. Nylatron® GS (GS) is a trademark for molybdenum disulfide filled nylon produced by the Polymer Corp. Nylatron® GS exhibits excellent abrasion resistance. Nylatron® GS is dark gray in color. Good up to 225°F maximum.
4. Teflon filled Acetal (AF) — Teflon.® This material has excellent abrasion and corrosion resistance and high lubricity against steel. Good up to 225°F maximum.
5. Teflon filled Nylon (TN) used for Hanger Bearings only, is light gray in color.

Roll End Bearings

These bearings are available in almost every conceivable size directly from stock — no costly waiting, tooling or set-up charges.

Sizes are interchangeable with existing wood and ball bearings. Several objectives can be met with Roll End Bearings made of our selected plastic resins.

1. No lubricant required
2. Clean — Neat appearance
3. Non-contamination
4. Resistant to moisture & chemicals
5. Quiet operation
6. Excellent load & wear ratings

Size variation is easily accomplished by rebores or remachine operations, simply state size desired. Bores can be reduced with bushing inserts. Adaptors are available for hex shafts.

(AF) Roll End Bearings, 3" and up, are Delrin or Celcon with a Teflon filled Acetal bushing. This combination provides a low cost unit with the superior properties of a Teflon filled bearing. However, one piece Teflon filled Acetal bearings can be offered upon request.

For bearings not shown — write for prices stating quantity desired.

Blind Bore Bearings

Blind Bore Bearings are available on special order. Minimum quantities will apply. They are available for roll end bearing sizes 818 through 2216 and 8P40 through 20P40. Depth of blind bores is 1/8" less than total bearing length. When ordering, add "B" to Catalog Number.

Selection

A general guide to determination of limiting load and velocity values for sleeve bearings has been established by the use of PV calculations. PV represents Pressure x Velocity, for example: 100 psi x 20 fpm yields a PV of 2000.

Maximum PV values for BostonE Molded Plastic Bearings are:

- Nylon (N) — 3,000
- Delrin or Celcon (D) — 3,000
- Nylatron GS (GS) — 4,000
- Teflon filled Acetal (AF) — 8,000
- Teflon filled nylon (TN) — 10,000

For complete selection and application information, see Engineering Section, Pages 174-181.

Teflon® is a registered trademark of Dupont.

BOSStonE Molded Plastic Bearings

Plain Cylindrical Bearings

ALL DIMENSIONS IN INCHES
ORDER BY CATALOG NUMBER OR ITEM CODE

A*	B*	C	Catalog Number	Item† Code
1/4	1/2	7/8	GS48-7	57551
5/16	1/2	7/8	GS58-7	57552
3/8	1/2	7/8	GS68-7	57553
1/2	5/8	1	AF810-8	57555
5/8	3/4	3/4	GS1012-6	57557
			AF1012-6	57558
5/8	3/4	1-1/2	GS1012-12	57559
			AF1012-12	57560
3/4	1	1-1/2	GS1216-12	57561
			AF1216-12	57562
1	1-1/4	2	GS1620-16	57565

†Any item listed WITHOUT an item Code Number is available on a SPECIAL ORDER BASIS and minimum quantities may apply.

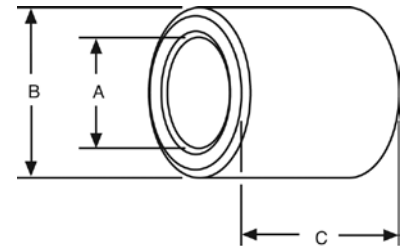

Material

Delrin or Celcon (Acetals) — D
Nylatron GS (Molybdenum disulfide filled nylon) — GS
Teflon filled Acetal (Teflon added to Delrin or Celcon) — AF

ALL DIMENSIONS IN INCHES
ORDER BY CATALOG NUMBER OR ITEM CODE

A*	B*	C	D	E	Catalog Number	Item Code
3/8	5/8	1	7/8	1/16	FGS610-8	57577
	3/4	1-1/2	1	1/16	FAF610-8	57578
					FAF612-12	57585
7/16	3/4	1-1/2	1	1/16	FAF712-12	57586
	1/2	5/8	1	7/8	1/16	FGS810-8
3/4		1-1/2	1	1/16	FAF810-8	57580
					FAF812-12	57587
		2			FGS812-16	57582
9/16	3/4	1-1/2	1	1/16	FAF912-12	57588
					FGS912-16	57583
5/8	3/4	1-1/2	1	1/16	FGS1012-12	57589
		2			FGS1012-16	57584
		1-1/2			FAF1012-12	57590
3/4	1	1-1/2	1-1/4	1/8	FGS1216-12	57591
					FAF1216-12	57592
1	1-1/4	2	1-1/2	1/8	FGS1620-16	57593
					FAF1620-16	57594
1-1/2	1-3/4	1-1/2	2	1/8	FAF2428-12	57606

*Approx. dimensions. Actual size related to molding variations, however, wall thickness will be quite uniform making it practical to use these bearings for many applications.

Flanged Type

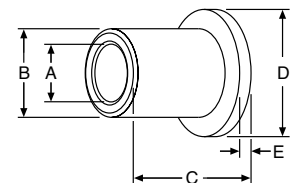

Material

Nylatron GS (Molybdenum disulfide filled nylon) — GS
Teflon filled Acetal (Teflon added to Delrin or Celcon) — AF

BOSStonE Molded Plastic Bearings

Roll End Bearings for Steel Tubing

F

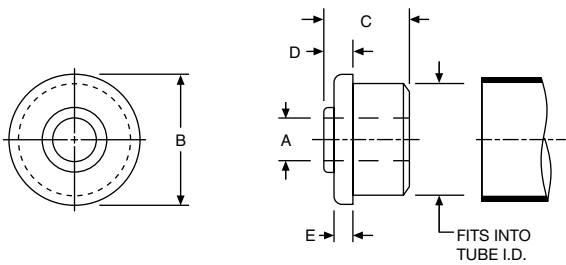

Material

Delrin or Celcon (Acetals) — D
 Nylatron GS (Molybdenum disulfide filled nylon) — GS
 Teflon filled Acetal (Teflon added to Delrin or Celcon) — AF

*These dimensions are approximately 1/64" larger than listed.

†Any item listed WITHOUT an Item Code Number is available on a SPECIAL ORDER BASIS and minimum quantities may apply.

BLIND BORE Bearings are available on special order — minimum quantities will apply.

ALL DIMENSIONS IN INCHES
 ORDER BY CATALOG NUMBER OR ITEM CODE †

B (Tube Size)	A*	C	D	E	Catalog Number	Item † Code
3/4 22 ga.	1/8	9/16	5/32	3/32	622D-1/8	56920
	3/16				622GS-1/8	56923
					622AF-1/8	56926
.750 O.D. .694 I.D.	1/4	9/16	5/32	3/32	622D-3/16	56921
					622GS-3/16	56924
	622AF-3/16				56927	
7/8 20 ga.	1/4	9/16	5/32	3/32	622D-1/4	56922
	3/16				622GS-1/4	56925
					622AF-1/4	56928
— .875 O.D. .805 I.D.	3/16	9/16	5/32	3/32	720D-3/16	56929
	1/4				720AF-3/16	—
					3/8	720AF-1/4
1 18 ga.	1/4	9/16	3/16	1/8	720D-3/8	56931
	3/8				720AF-3/8	—
					1/2	—
1.000 O.D. .902 I.D.	1/4	9/16	3/16	1/8	818D-1/4	56938
	3/8				818GS-1/4	56941
					1/2	818AF-1/4
1.250 O.D. 1.120 I.D.	1/4	5/8	3/16	1/8	818GS-3/8	56942
					818AF-3/8	56945
	3/8				818D-1/2	56940
1-1/4 16 ga.	1/4	5/8	3/16	1/8	818GS-1/2	56943
					818AF-1/2	56946
	3/8				1016D-1/4	56947
1.375 O.D. 1.277 I.D.	1/4	3/4	1/4	1/8	1016GS-1/4	56950
					3/8	1016AF-1/4
	1/2				1016D-3/8	56948
1-3/8 18 ga.	5/16	3/4	1/4	1/8	1016GS-3/8	56951
					3/8	1016AF-3/8
	1/2				1016D-1/2	56949
1.500 O.D. 1.370 I.D.	1/4	7/8	5/16	3/16	1016GS-1/2	56952
					3/8	1016AF-1/2
	1/2				1118D-1/4	56956
1-1/2 16 ga.	3/8	7/8	5/16	3/16	1118GS-1/4	56960
					1/2	1118AF-1/4
	5/8				1118D-5/16	56957
1.740 O.D. 1.610 I.D.	1/4	1	5/16	3/16	1118GS-5/16	56961
					3/8	1118AF-5/16
	1/2				1118D-3/8	56958
3/8 1-1/2 EMT	1/4	1	5/16	3/16	1118GS-3/8	56962
					3/8	1118AF-3/8
	1/2				1118D-1/2	56959
1.740 O.D. 1.610 I.D.	1/4	1	5/16	3/16	1118GS-1/2	56963
					3/8	1118AF-1/2
	5/8				1216D-1/4	56968
1-1/2 16 ga.	3/8	7/8	5/16	3/16	1216GS-1/4	56972
					1/2	1216AF-1/4
	5/8				1216D-3/8	56969
1.500 O.D. 1.370 I.D.	1/4	7/8	5/16	3/16	1216GS-3/8	56977
					3/8	1216AF-3/8
	1/2				1216D-5/8	56971
3/8 1-1/2 EMT	1/4	1	5/16	3/16	1216GS-5/8	56975
					3/8	1216AF-5/8
	1/2				12EMD-1/4	—
1.740 O.D. 1.610 I.D.	1/4	1	5/16	3/16	12EMGS-1/4	—
					3/8	12EMAF-1/4
	5/8				12EMD-3/8	56981
1-1/2 16 ga.	3/8	7/8	5/16	3/16	12EMGS-3/8	—
					1/2	12EMAF-3/8
	5/8				12EMD-1/2	56982
1.740 O.D. 1.610 I.D.	1/4	1	5/16	3/16	12EMGS-1/2	56986
					3/8	12EMAF-1/2
	1/2				12EMD-5/8	56983
1.740 O.D. 1.610 I.D.	1/4	1	5/16	3/16	12EMGS-5/8	56987
					3/8	12EMAF-5/8
	5/8				—	—

BOSStonE Molded Plastic Bearings

Roll End Bearings for Steel Tubing

ALL DIMENSIONS IN INCHES
ORDER BY CATALOG NUMBER OR ITEM CODE †

B (Tube Size)	A*	C	D	E	Catalog Number	Item † Code
1-5/8 16 ga. 1.625 O.D. 1.495 I.D.	1/4	1	5/16	3/16	1316D-1/4	—
					1316GS-1/4	56996
					1316AF-1/4	—
	3/8				1316D-3/8	56993
					1316GS-3/8	56997
					1316AF-3/8	—
	1/2				1316D-1/2	56994
					1316GS-1/2	56998
					1316AF-1/2	—
	5/8				1316D-5/8	56995
					1316GS-5/8	56999
					1316AF-5/8	—
1-3/4 16 ga. 1.750 O.D. 1.620 I.D.	1/4	1	5/16	3/16	1416D-1/4	57070
					1416GS-1/4	57075
					1416AF-1/4	—
	3/8				1416D-3/8	57071
					1416GS-3/8	57076
					1416AF-3/8	—
	1/2				1416D-1/2	57072
					1416GS-1/2	57077
					1416AF-1/2	—
	5/8				1416D-5/8	57073
					1416GS-5/8	57078
					1416AF-5/8	57083
3/4	1416D-3/4	57074				
	1416GS-3/4	57079				
	1416AF-3/4	57084				
1-7/8 16 ga. 1.875 O.D. 1.745 I.D.	1/4	1	5/16	3/16	1516D-1/4	57085
					1516GS-1/4	57090
					1516AF-1/4	—
	3/8				1516D-3/8	57086
					1516GS-3/8	57091
					1516AF-3/8	—
	1/2				1516D-1/2	57087
					1516GS-1/2	57092
					1516AF-1/2	—
	5/8				1516D-5/8	57088
					1516GS-5/8	57093
					1516AF-5/8	—
3/4	1516D-3/4	—				
	1516GS-3/4	57094				
	1516AF-3/4	—				
2 18 ga. 2.000 O.D. 1.902 I.D.	1/4	1	5/16	3/16	1618D-1/4	57872
					1618GS-1/4	57877
					1618AF-1/4	—
	3/8				1618D-3/8	—
					1618GS-3/8	—
					1618AF-3/8	—
	1/2				1618D-1/2	57874
					1618GS-1/2	57879
					1618AF-1/2	—
	5/8				1618D-5/8	57875
					1618GS-5/8	57880
					1618AF-5/8	—
3/4	1618D-3/4	57876				
	1618GS-3/4	57881				
	1618AF-3/4	—				
2 16 ga. 2.000 O.D. 1.8701 I.D.	1/4	1	5/16	3/16	1616D-1/4	57100
					1616GS-1/4	57105
					1616AF-1/4	—
	3/8				1616D-3/8	57101
					1616GS-3/8	57106
					1616AF-3/8	—
	1/2				1616D-1/2	57102
					1616GS-1/2	57107
					1616AF-1/2	57112
	5/8				1616D-5/8	57103
					1616GS-5/8	57108
					1616AF-5/8	—
3/4	1616D-3/4	57104				
	1616GS-3/4	—				
	1616AF-3/4	—				

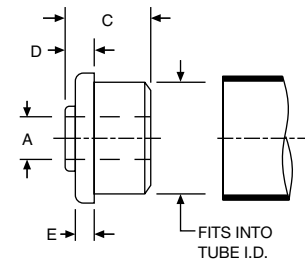
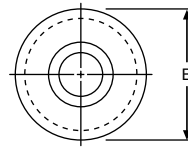

Material

Delrin or Celcon (Acetals) — D
Nylatron GS (Molybdenum disulfide filled nylon) — GS
Teflon filled Acetal (Teflon added to Delrin or Celcon) — AF

*These dimensions are approximately 1/64" larger than listed.

†Any item listed WITHOUT an Item Code Number is available on a SPECIAL ORDER BASIS and minimum quantities may apply.

BLIND BORE Bearings are available on special order — minimum quantities will apply.

BOSStonE Molded Plastic Bearings

Roll End Bearings for Steel Tubing

F

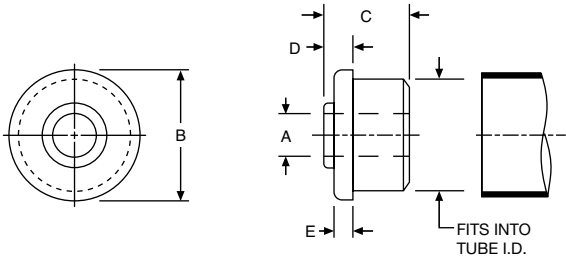

Material

Delrin or Celcon (Acetals) — D
 Nylatron GS (Molybdenum disulfide filled nylon) — GS
 Teflon filled Acetal (Teflon added to Delrin or Celcon) — AF

*These dimensions are approximately 1/64" larger than listed.

†Any item listed WITHOUT an Item Code Number is available on a SPECIAL ORDER BASIS and minimum quantities may apply.

BLIND BORE Bearings are available on special order — minimum quantities will apply.

ALL DIMENSIONS IN INCHES
 ORDER BY CATALOG NUMBER OR ITEM CODE †

B (Tube Size)	A*	C	D	E	Catalog Number	Item † Code
2 EMT	1/4	1	5/16	3/16	16EMD-1/4	—
	3/8				16EMGS-1/4	—
					16EMAF-1/4	—
					16EMD-3/8	—
	1/2				16EMGS-3/8	—
16EMAF-3/8		—				
16EMD-1/2		57117				
5/8	16EMGS-1/2	—				
	16EMAF-1/2	—				
	16EMD-5/8	57118				
2.190 O.D. 2.067 I.D.	3/4	1	5/16	3/16	16EMGS-5/8	—
					16EMAF-5/8	—
					16EMD-3/4	57119
					16EMGS-3/4	—
					16EMAF-3/4	—
					16EMD-1/4	—
2-1/4 18 ga.	1/4	1	5/16	3/16	1818GS-1/4	57862
	3/8				1818AF-1/4	—
					1818D-3/8	—
					1818GS-3/8	—
	1/2				1818AF-3/8	—
1818D-1/2		—				
1818GS-1/2		—				
5/8	1818AF-1/2	—				
	1818D-5/8	—				
	1818GS-5/8	—				
2.250 O.D. 2.152 I.D.	3/4	1	5/16	3/16	1818AF-5/8	—
					1818D-3/4	—
					1818GS-3/4	—
					1818AF-3/4	—
					1818D-1/4	57130
					1816GS-1/4	—
2-1/4 16 ga.	1/4	1	5/16	3/16	1816AF-1/4	—
	3/8				1816D-3/8	57131
					1816GS-3/8	57136
					1816AF-3/8	—
	1/2				1816D-1/2	57132
1816GS-1/2		57137				
1816AF-1/2		—				
5/8	1816D-5/8	57133				
	1816GS-5/8	—				
	1816AF-5/8	—				
2.250 O.D. 2.120 I.D.	3/4	1	5/16	3/16	1816D-3/4	57134
					1816GS-3/4	—
					1816AF-3/4	—
2-1/2 18 ga.	1/4	1	5/16	3/16	2018D-1/4	—
	3/8				2018GS-1/4	—
					2018AF-1/4	—
					2018D-3/8	—
	1/2				2018GS-3/8	—
2018AF-3/8		—				
2018D-1/2		—				
5/8	2018GS-1/2	—				
	2018AF-1/2	—				
	2018D-5/8	—				
2.500 O.D. 2.402 I.D.	3/4	1	5/16	3/16	2018GS-5/8	—
					2018AF-5/8	—
					2018D-3/4	—
					2018GS-3/4	—
					2018AF-3/4	—
					2018D-1/4	57145
2-1/2 16 ga.	1/4	1	5/16	3/16	2016GS-1/4	—
	3/8				2016AF-1/4	—
					2016D-3/8	—
1/2		2016GS-3/8	—			
	2016AF-3/8	—				
	2016D-1/2	57147				
5/8	2016GS-1/2	57152				
	2016AF-1/2	—				
	2016D-5/8	57148				
2.500 O.D. 2.370 I.D.	3/4	1	5/16	3/16	2016GS-5/8	57153
					2016AF-5/8	—
					2016D-3/4	57149
					2016GS-3/4	57154
					2016AF-3/4	—
					2016D-1/4	—

BOSStonE Molded Plastic Bearings

Roll End Bearings for Steel Tubing

ALL DIMENSIONS IN INCHES
ORDER BY CATALOG NUMBER OR ITEM CODE †

B (Tube Size)	A*	C	D	E	Catalog Number	Item † Code
2-3/4 16 ga. 2.750 O.D. 2.620 I.D.	1/4	1	5/16	3/16	2216D-1/4	57160
					2216GS-1/4	—
					2216AF-1/4	—
	3/8				2216D-3/8	57161
					2216GS-3/8	—
					2216AF-3/8	—
	1/2				2216D-1/2	57162
					2216GS-1/2	—
	2216AF-1/2				—	
	5/8				2216D-5/8	57163
2216GS-5/8		—				
2216AF-5/8	—					
3/4	2216D-3/4	—				
	2216GS-3/4	—				
2216AF-3/4	—					
3 16 ga. 3.000 O.D. 2.870 I.D.	3/8	2416D-3/8	57607			
		2416GS-3/8	57611			
		2416AF-3/8	57615			
	1/2	2416D-1/2	57608			
		2416GS-1/2	57612			
		2416AF-1/2	57616			
	5/8	2416D-5/8	57609			
		2416GS-5/8	57613			
		2416D-3/4	57610			
3/4	2416GS-3/4	57614				
	2416AF-3/4	57618				
	3 11 ga. 3.000 O.D. 2.760 I.D.	3/8	2411D-3/8	57175		
2411GS-3/8			57179			
2411AF-3/8			57183			
1/2		2411D-1/2	57176			
		2411GS-1/2	57180			
		2411AF-1/2	57184			
5/8		2411D-5/8	57177			
		2411GS-5/8	57181			
		2411AF-5/8	57185			
3/4	2411D-3/4	57178				
	2411GS-3/4	57182				
	2411AF-3/4	57186				
4 11 ga. 4.000 O.D. 3.760 I.D.	1/2	2	3/8	3211D-1/2	57187	
		2	3/8	3211GS-1/2	57192	
		2-1/8	1/2	3211AF-1/2	57197	
	5/8	2	3/8	3211D-5/8	57188	
		2	3/8	3211GS-5/8	57193	
		2-1/8	1/2	3211AF-5/8	57198	
	3/4	2	3/8	3211D-3/4	57189	
		2	3/8	3211GS-3/4	57194	
		2-1/8	1/2	3211AF-3/4	57199	
	1	2	3/8	3211D-1	57190	
		2	3/8	3211GS-1	57195	
		2-1/8	1/2	3211AF-1	57200	
1-1/4	2	3/8	3211D-1-1/4	57191		
	2	3/8	3211GS-1-1/4	57196		
	2-1/8	1/2	3211AF-1-1/4	—		
4-1/2 11 ga. 4.500 O.D. 4.260 I.D.	1/2	1-3/4	3/8	3611D-1/2	—	
		1-3/4	3/8	3611GS-1/2	—	
		1-7/8	1/2	3611AF-1/2	—	
	5/8	1-3/4	3/8	3611D-5/8	—	
		1-3/4	3/8	3611GS-5/8	—	
		1-7/8	1/2	3611AF-5/8	—	
	3/4	1-3/4	3/8	3611D-3/4	—	
		1-3/4	3/8	3611GS-3/4	—	
		1-7/8	1/2	3611AF-3/4	—	
1	1-3/4	3/8	3611GS-1	—		
	1-7/8	1/2	3611AF-1	—		
	1-3/4	3/8	3611D-1-1/4	—		
1-1/4	1-3/4	3/8	3611GS-1-1/4	—		
	1-7/8	1/2	3611AF-1-1/4	—		

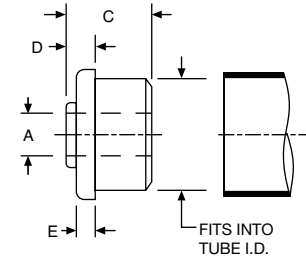
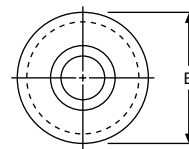

Material

Delrin or Celcon (Acetals) — D
Nylatron GS (Molybdenum disulfide filled nylon) — GS
Teflon filled Acetal (Teflon added to Delrin or Celcon) — AF

*These dimensions are approximately 1/64" larger than listed.

†Any item listed WITHOUT an Item Code Number is available on a SPECIAL ORDER BASIS and minimum quantities may apply.

AF Bearings with 3" or larger O.D. will be supplied with an AF Flanged bushing inserted into a D or GS Roll End Bearing. For these AF Bearings it is recommended to reduce the shaft diameter or increase bushing I.D. to obtain proper clearance.

BLIND BORE Bearings are available on special order. Minimum quantities will apply.

BOSStonE Molded Plastic Bearings

Roll End Bearings for Steel Tubing and Standard Pipe

F

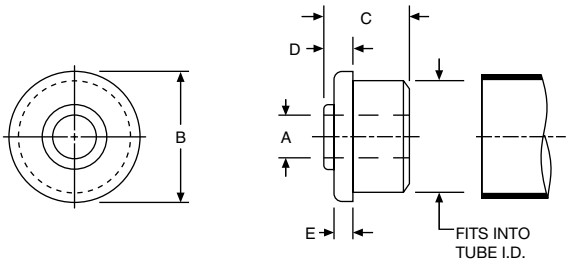

Material

Delrin or Celcon (Acetals) — D
 Nylatron GS (Molybdenum disulfide filled nylon) — GS
 Teflon filled Acetal (Teflon added to Delrin or Celcon) — AF

ALL DIMENSIONS IN INCHES
 ORDER BY CATALOG NUMBER OR ITEM CODE †

B (Pipe Size)	A*	C	D	E	Catalog Number	Item † Code				
1 Sch. 40 1.315 O.D. 1.049 I.D.	1/4	5/8	3/16	1/8	8P40D-1/4	57334				
	3/8				8P40GS-1/4	57337				
					8P40AF-1/4	—				
					8P40D-3/8	57335				
	1/2				8P40GS-3/8	57338				
					8P40AF-3/8	—				
					8P40D-1/2	57336				
	1-1/2 Sch. 40 1.900 O.D. 1.610 I.D.				1/4	1	5/16	3/16	12P40D-1/4	57343
					3/8				12P40GS-1/4	57347
12P40AF-1/4		57351								
12P40D-3/8		57344								
1/2		12P40GS-3/8	57348							
		12P40AF-3/8	57352							
		12P40D-1/2	57345							
5/8		12P40GS-1/2	57349							
		12P40AF-1/2	—							
		12P40D-5/8	57346							
1-1/2 Sch. 80 1.900 O.D. 1.500 I.D.		1/4	1	5/16	3/16				12P80D-1/4	—
		3/8							12P80GS-1/4	—
	12P80AF-1/4					—				
	12P80D-3/8					—				
	1/2	12P80GS-3/8				—				
		12P80AF-3/8				—				
		12P80D-1/2				57663				
	5/8	12P80GS-1/2				—				
		12P80AF-1/2				—				
		12P80D-5/8				57664				
	2 Sch.40 2.375 O.D. 2.067 I.D.	1/4				1	5/16	3/16	16P40D-1/4	57355
		3/8							16P40GS-1/4	—
16P40AF-1/4			—							
16P40D-3/8			57356							
1/2		16P40GS-3/8	—							
		16P40AF-3/8	—							
		16P40D-1/2	57357							
5/8		16P40GS-1/2	57362							
		16P40AF-1/2	—							
		16P40D-5/8	57358							
3/4		16P40GS-5/8	57363							
		16P40AF-5/8	—							
	16P40D-3/4	57359								
3/4	16P40GS-3/4	57364								
	16P40AF-3/4	—								

*These dimensions are approximately 1/64" larger than listed.

†Any item listed WITHOUT an Item Code Number is available on a SPECIAL ORDER BASIS and minimum quantities may apply.

BLIND BORE Bearings are available on special order.
 Minimum quantities will apply.

BOSStonE Molded Plastic Bearings

Roll End Bearings for Standard Steel Pipe

ALL DIMENSIONS IN INCHES
ORDER BY CATALOG NUMBER OR ITEM CODE †

B (Pipe Size)	A*	C	D	E	Catalog Number	Item Code †
2 Sch.10 2.375 O.D. 2.152 I.D.	1/4	1	5/16	3/16	16P10D-1/4	—
					16P10GS-1/4	—
					16P10AF-1/4	—
	3/8				16P10D-3/8	—
					16P10GS-3/8	—
					16P10AF-3/8	—
	1/2				16P10D-1/2	—
					16P10GS-1/2	—
					16P10AF-1/2	—
	5/8				16P10D-5/8	—
					16P10GS-5/8	—
					16P10AF-5/8	—
3/4	16P10D-3/4	—				
	16P10GS-3/4	—				
	16P10AF-3/4	—				
2 Sch.80 2.375 O.D. 1.939 I.D.	1/4	1	5/16	3/16	16P80D-1/4	—
					16P80GS-1/4	—
					16P80AF-1/4	—
	3/8				16P80D-3/8	—
					16P80GS-3/8	—
					16P80AF-3/8	—
	1/2				16P80D-1/2	57690
					16P80GS-1/2	57695
					16P80AF-1/2	—
	5/8				16P80D-5/8	57691
					16P80GS-5/8	—
					16P80AF-5/8	—
3/4	16P80D-3/4	57692				
	16P80GS-3/4	—				
	16P80AF-3/4	—				
2-1/2 Sch.40 2.875 O.D. 2.469 I.D.	1/4	1	5/16	3/16	20P40D-1/4	57370
					20P40GS-1/4	—
					20P40AF-1/4	—
	3/8				20P40D-3/8	57371
					20P40GS-3/8	—
					20P40AF-3/8	—
	1/2				20P40D-1/2	57372
					20P40GS-1/2	—
					20P40AF-1/2	—
	5/8				20P40D-5/8	57373
					20P40GS-5/8	—
					20P40AF-5/8	—
3/4	20P40D-3/4	57374				
	20P40GS-3/4	—				
	20P40AF-3/4	—				
3 Sch.40 3.500 O.D. 3.068 I.D.	3/8	1-1/4	3/8	3/16	24P40D-3/8	57385
		1-1/4	3/8		24P40GS-3/8	57390
		1-3/8	1/2		24P40AF-3/8	57395
	1/2	1-1/4	3/8	3/16	24P40D-1/2	57386
		1-1/4	3/8		24P40GS-1/2	57391
		1-3/8	1/2		24P40AF-1/2	57396
	5/8	1-1/4	3/8	3/16	24P40D-5/8	57387
		1-1/4	3/8		24P40GS-5/8	57392
		1-3/8	1/2		24P40AF-5/8	57397
	3/4	1-1/4	3/8	3/16	24P40D-3/4	57388
		1-1/4	3/8		24P40GS-3/4	57393
		1-3/8	1/2		24P40AF-3/4	57398
1	1-1/4	3/8	3/16	24P40D-1	57389	
	1-1/4	3/8		24P40GS-1	57394	
	1-3/8	1/2		24P40AF-1	57399	

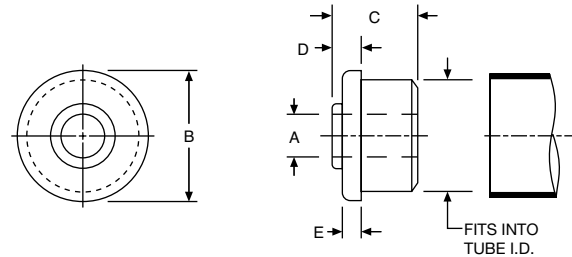

Material

Delrin or Celcon (Acetals) — D
Nylatron GS (Molybdenum disulfide filled nylon) — GS
Teflon filled Acetal (Teflon added to Delrin or Celcon) — AF

*These dimensions are approximately 1/64" larger than listed.

†Any item listed WITHOUT an Item Code Number is available on a SPECIAL ORDER BASIS and minimum quantities may apply.

AF Bearings with 3" or larger O.D. will be supplied with an AF Flanged bushing inserted into a D or GS Roll End Bearing. For these AF Bearings it is recommended to reduce the shaft diameter or increase bushing I.D. to obtain proper clearance.

BLIND BORE bearings are available on special order. Minimum quantities will apply.

BOSStonE Molded Plastic Bearings

Roll End Bearings for Standard Steel Pipe

F



ALL DIMENSIONS IN INCHES
ORDER BY CATALOG NUMBER OR ITEM CODE †

B (Pipe Size)	A*	C	D	E	Catalog Number	Item † Code
4 Sch. 40	1/2	1-3/4	3/8		32P40D-1/2	57400
		1-3/4	3/8	3/16	32P40GS-1/2	57405
		1-7/8	1/2		32P40AF-1/2	57410
	5/8	1-3/4	3/8		32P40D-5/8	57401
		1-3/4	3/8	3/16	32P40GS-5/8	57406
		1-7/8	1/2		32P40AF-5/8	57411
	3/4	1-3/4	3/8		32P40D-3/4	57402
		1-3/4	3/8	3/16	32P40GS-3/4	57407
		1-7/8	1/2		32P40AF-3/4	57412
	1	1-3/4	3/8		32P40D-1	57403
		1-3/4	3/8	3/16	32P40GS-1	57408
		1-7/8	1/2		32P40AF-1	57411
4.500 O.D.		1-3/4	3/8		32P40D-1-1/4	57404
4.026 I.D.	1-1/4	1-3/4	3/8	3/16	32P40GS1-1/4	57409

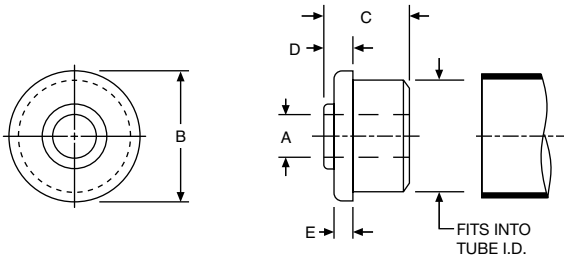

AF bearings with 3" or larger O.D. will be supplied with an AF Flanged bushing inserted into a D or GS Roll End Bearing. For these AF Bearings it is recommended to reduce the shaft diameter or increase bushing I.D. to obtain proper clearance.

BLIND BORE bearings are available on special order — minimum quantities will apply.

Material

Delrin or Celcon (Acetals) — D
Nylatron GS (Molybdenum disulfide filled nylon) — GS
Teflon filled Acetal (Teflon added to Delrin or Celcon) — AF

*These dimensions are approximately 1/64" larger than listed.

†Any item listed WITHOUT an Item Code Number is available on a SPECIAL ORDER BASIS — minimum quantities may apply.

BOSStonE Molded Plastic Bearings

Extra Length – Blind Bore Bearing Inserts

Extra length Blind Bore inserts are available for Roll End Bearings from 1-3/4" to 6" outside diameter. All Blind Bore Bearing inserts listed below are made from Nylatron GS and are designed to press fit into 3/4" I.D. Roll End Bearings.

**ALL DIMENSIONS IN INCHES
ORDER BY CATALOG NUMBER OR ITEM CODE**

Roll End Brg. Bore	A*	B	C	Max. Depth	D	Catalog Number	Item Code
3/4	7/16	1	1-1/2	1-3/8	1/16	F7612B	57482
	1/2					F8612B	57483
	9/16					F9612B	57484
	5/8					F10612B	-
3/4	7/16	1	2	1-7/8	1/16	F7616B	57486
	1/2					F8616B	57487
	9/16					F9616B	57488
	5/8					F10616B	57489

* These dimensions are approximately 1/64" larger than listed.

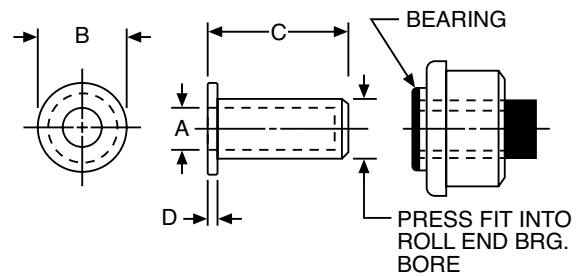

Roll End Adapter for Hex Shaft

Hex shaft adapter bushings are available for Roll End Bearings from 1" to 6" outside diameter. All hex shaft adapter bushings are made from Nylatron GS and are designed to provide a running fit with the Roll End Bearing bores listed below.

**ALL DIMENSIONS IN INCHES
ORDER BY CATALOG NUMBER OR ITEM CODE**

A Hex Shaft Size	Roll End Brg. Bore +	B	C	D	Catalog Number	Item Code
5/16	1/2	3/4	7/8	1/16	FH547	57479
7/16	5/8	7/8	1	1/16	FH758	57481
5/8	7/8*	1-1/8	1-1/4	3/32	FH10710	57707
11/16	7/8*	1-1/8	1-1/4	3/32	FH11710	57708

*7/8" I.D. Roll End Bearings are not available from stock. They may be machined from any 3/4" bore size. Prices on application.

+I.D. of "AF" Roll End bearings may have to be enlarged approximately 1/64" to obtain proper clearance.

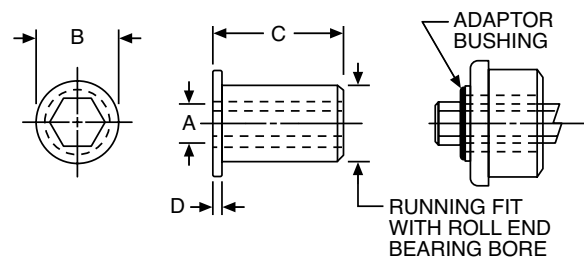

BOSStonE Molded Plastic Bearings

Guide Roll Bearings

F



Nylatron GS Roll End Bearing has an oversized flange. Designed for use as a belt guide on conveyor rollers, or on light duty trolley conveyors. Using 2" 16 Gage Tubing.

Material

Nylatron GS (Molybdenum disulfide filled nylon) — GS

**ALL DIMENSIONS IN INCHES
ORDER BY CATALOG NUMBER
OR ITEM CODE**

A	Catalog Number	Item Code
1/2	G1616GS-1/2	57704
5/8	G1616GS-5/8	57706

Also suitable to take 5/16, 3/8 and 7/16" hex shaft bushing.

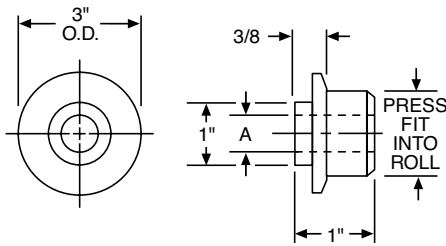

Rollers



These rollers are made from roll end bearings shown on pages 162 through 168. (Ribbed Construction)

**ALL DIMENSIONS IN INCHES
ORDER BY CATALOG NUMBER OR ITEM CODE**

B	A*	C	D	E	Made From Cat. No.	Catalog Number	Item Code
.700	1/8	9/16	1/2	1/16	622D-1/8 622GS-1/8	R700D R700GS	57492 57493
.800	3/16	9/16	5/8	1/16	720D-3/16 720GS-3/16	R800D R800GS	57494 57495
.900	1/4	9/16	5/8	1/16	818D-1/4 818GS-1/4	R900D R900GS	57496 57497
1.120	3/8	5/8	5/8	1/16	1016D-3/8 1016GS-3/8	R1120D R1120GS	57498 57499
1.370	1/2	7/8	7/8	1/8	1216D-1/2 1216GS-1/2	R1370D R1370GS	57500 57501
1.500	1/2	1	1	1/8	1316D-1/2 1316GS-1/2	R1500D R1500GS	57502 57503
1.620	1/2	1	1	1/8	1416D-1/2 1416GS-1/2	R1620D R1620GS	57504 57505
1.870	1/2	1	1	1/8	1616D-1/2 1616GS-1/2	R1870D R1870GS	57506 57507
2.120	1/2	1	1	1/8	1816D-1/2 1816GS-1/2	R2120D R2120GS	57508 57509
2.370	1/2	1	1	1/8	2016D-1/2 2016GS-1/2	R2370D R2370GS	57510 57511
2.750	3/4	1-1/2	1-1/2	3/16	2411D-3/4 2411GS-3/4	R2750D R2750GS	57512 57513
3.000	3/4	1-1/4	2	3/16	24P40D-3/4 24P40GS-3/4	R3000D R3000GS	57514 57515
3.750	1	2	2	3/16	3211D-1	R3750D	57516
4.250	1	1-3/4	2	3/16	3611D-1	R4250D	57518

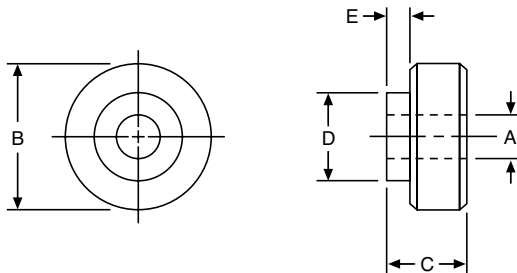

Material

Delrin or Celcon (Acetals) — D
Nylatron GS (Molybdenum disulfide filled nylon) — GS

*These dimensions are approximately 1/64" larger than listed.

BOSStonE Molded Plastic Bearings

Shaft Clip

Secures round shaft to conveyor frame. Shaft can't turn or slide out. Clip required on one end only, conventional cotter pin can be used on other end.

Available from stock for 1/2" dia. shaft.

ORDER BY CATALOG NUMBER OR ITEM CODE

Catalog Number	Item Code
SC-4	57490

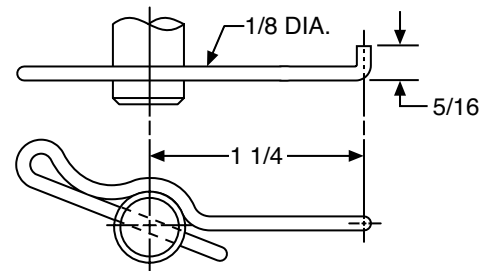
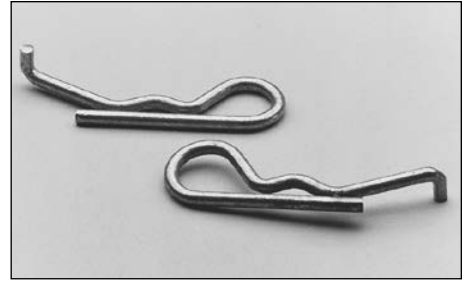

Stub Shaft for Rollers

This stainless steel screw and stub assembly fits Blind Bore Roll End Bearings.

ORDER BY CATALOG NUMBER OR ITEM CODE

Catalog Number	Item Code
SS-4	57491

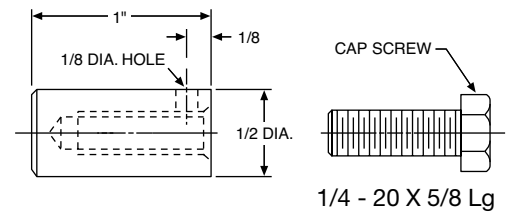

BOSonE Molded Nylon Bearings

Plain Cylindrical Bearings

F

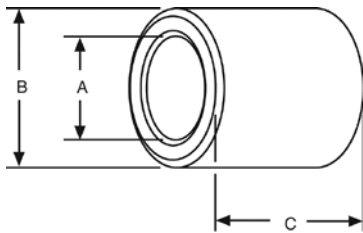
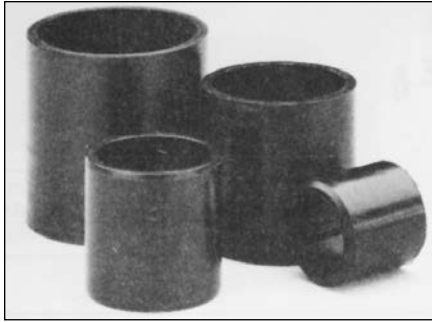

STANDARD TOLERANCES

DIMENSIONS		TOLERANCE
A	All	± .015
B		
C	All	± .015

ALL DIMENSIONS IN INCHES ORDER BY CATALOG NUMBER OR ITEM CODE

A	B	C	Catalog Number	Item Code
3/16	5/16	5/16	NS35-2-1/2	56883
1/4	3/8	3/8	NS46-3	56884
5/16	7/16	7/16	NS57-3-1/2	56885
3/8	1/2	1/2	NS68-4	56886
7/16	9/16	9/16	NS79-4-1/2	56887
1/2	5/8	5/8	NS810-5	56888
9/16	11/16	11/16	NS911-5-1/2	56889
5/8	3/4	3/4	NS1012-6	56890
11/16	13/16	13/16	NS1113-6-1/2	56891
3/4	7/8	7/8	NS1214-7	56892
7/8	1	1	NS1416-8	56894
15/16	1-1/16	1-1/16	NS1517-8-1/2	56895
1	1-1/8	1-1/8	NS1618-9	56896

Flanged Type

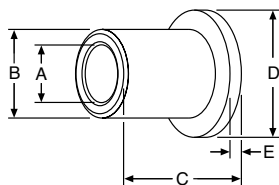

ALL DIMENSIONS IN INCHES ORDER BY CATALOG NUMBER OR ITEM CODE

A	B	C	D	E	Catalog Number	Item Code
3/16	5/16	5/16	7/16	1/16	NF35-2-1/2	56897
1/4	3/8	3/8	1/2	1/16	NF46-3	56898
5/16	7/16	7/16	9/16	1/16	NF57-3-1/2	56899
3/8	1/2	1/2	5/8	1/16	NF68-4	56900
1/2	5/8	5/8	3/4	1/16	NF810-5	56902
9/16	11/16	11/16	15/16	1/16	NF911-5-1/2	56903
5/8	3/4	3/4	7/8	1/16	NF1012-6	56904
11/16	13/16	13/16	1	1/16	NF1113-6-1/2	56905
3/4	7/8	7/8	1-1/16	1/16	NF1214-7	56906
7/8	1	1	1-3/16	1/16	NF1416-8	56908
15/16	1-1/16	1-1/16	1-1/4	1/16	NF1517-8-1/2	56909
1	1-1/8	1-1/8	1-5/16	1/16	NF1618-9	56910

STANDARD TOLERANCES

DIMENSIONS		TOLERANCE
A	All	± .015
B		
D		
E		
C	All	± .015

BOSStonE Molded Nylon Bearings

Thrust Type

ALL DIMENSIONS IN INCHES
ORDER BY CATALOG NUMBER OR ITEM CODE

A	B	C	Catalog Number	Item Code
3/16 .189	3/4 .750	1/16 .070	NT312	56911
1/4 .255	5/8 .620	3/32 .097	NT410	56912
1/2 .503	13/16 .820	3/32 .095	NT813	56913
9/16 .565	13/16 .812	3/32 .095	NT913	56914
5/8 .630	1 1.000	3/32 .094	NT1016	56915
3/4 .760	1-1/16 1.063	3/32 .094	NT1217	56916
7/8 .890	1-1/8 1.125	3/32 .094	NT1418	56917
1-1/4 1.290	2-1/8 2.140	3/32 .098	NT2034	56918
1-1/2 1.555	2-1/16 2.058	1/8 .120	NT2533	56919

Tolerances apply to actual (decimal) dimensions.

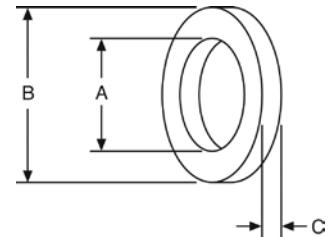

STANDARD TOLERANCES

DIMENSIONS		TOLERANCE
A B C	All	± .015

ALL DIMENSIONS IN INCHES
ORDER BY CATALOG NUMBER OR ITEM CODE

A	C	G	F	H	J	Cable Size	Catalog Number	Item Code
1-1/4	1/4	.400		1/2	31/32	1/4	P1250-2	57522
2-5/8	3/8	.500	.017	3/4	2-1/8	1/4	P2625-3	57525
2-5/8	1/2	.500	—	3/4	2-1/8	1/4	P2625-4	57526

STANDARD TOLERANCES

DIMENSIONS	TOLERANCE
C	All
	+ .005 to + .010

Cable Pulleys

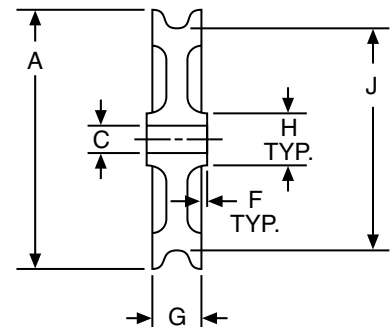

Sleeve Bearing Selection

F

The performance of a bearing is influenced by the conditions of speed, mating materials, clearances, temperature, lubrication, type of loading, etc. Of primary importance, is the maintenance of an oil film between the bearing surfaces to reduce friction, dissipate heat and retard wear by minimizing metal to metal contact. The most critical periods of operation are during starting and stopping, when the load may cause the bearing surfaces to come into contact with each other. For these reasons it is not practical to predict the wear rate of bronze bearings.

The selection of the best bearing for an application can be a very complicated problem because the combined influence of the many factors affecting the operation is difficult to predict.

The following information may be used as a guide for selecting a Bronze sleeve bearing which should satisfy the requirements.

For practical reasons, the length of the bearing should normally be between one and two times the shaft diameter and the O.D. approximately 25% larger than the shaft diameter.

Starting and Stopping/

Oscillatory Motion/Cyclical Overload conditions mean a full film of oil cannot be maintained. When this happens, metal-to-metal contact occurs and causes bearing wear. Because of the continual interruption of the oil film, a larger safety factor is required when designing bearings for applications of this type. A lower permissible PV factor must be considered.

Speed/Oil Viscosity must also be considered. The proper viscosity oil must be selected for each particular speed application, to achieve optimum bearing operation.

For high speed applications, a light oil (150 SUS at 100°F) is required to keep internal oil friction at a minimum and assure proper metering of the oil to the bearing/shaft surface.

For moderate speeds, a medium-viscosity oil (400 SUS at 100°F) is required.

For very low shaft speeds under moderate or heavy loads, a heavier oil with an extreme pressure additive may be required to prevent complete oil film rupture and give sufficient lubrication for proper operation.

Shaft Consideration is extremely important in bearing applications. For optimum operation the shaft must be of proper material, hardness, surface finish, roundness and dimensions. Experience indicates that carbon steels, and preferably C1137, offer the best operating results. If stainless steel shafts are to be used, 400 Series is recommended. Austenitic 300 Series stainless steel tends to gall, which results in extreme wear and shortened life. If 300 Series stainless is required for its non-magnetic qualities, it is strongly recommended that shafts be work-hardened or chrome-plated for satisfactory operation.

For best results, a shaft surface finish of 4 to 12 RMS is recommended. Nicks, gouges, and burrs should be avoided because they rupture the oil film and cause metal-to-metal contact.

Shaft roundness and dimensions also contribute greatly to bearing life. The more round the shaft, the less the bearing and shaft wear, with longer life resulting. Dimensions also play an important role in operation and should always be in accord with the recommended bearing clearance charts.

As stated, for practical reasons the bearing length should normally be between one and two times the shaft diameter. However, the recommended practice is by using the PV factor. PV is a means of measuring the performance capabilities of bearings. P is expressed as pressure or pounds per square inch on the projected area of the bearing. V is velocity in feet per minute of the wear surface (surface feet per minute).

“PV” is expressed by the following:

$$PV = \frac{W}{Ld} \times \frac{\pi dn}{12} = \frac{\pi Wn}{12L} = \frac{.262Wn}{L}$$

$$P = \frac{W}{A \text{ (Brg. I.D. x Length)}}$$

$$V = \text{Surface velocity of the shaft, ft./min.} \\ (.262 \times \text{RPM} \times \text{Shaft Dia.})$$

$$W = \text{Bearing load in pounds}$$

$$L = \text{Bearing length in inches}$$

$$d = \text{I.D. of bearing in inches} \\ (\text{cancels out of formula})$$

$$n = \text{Shaft speed, RPM}$$

Sleeve Bearing Selection (Continued)

Each material has a specific maximum PV rating, as shown in the following Table. In addition, it also has a maximum pressure (P) and velocity (V) limitation. These values should not be exceeded. At no time can all maximum values be utilized.

Material	Max. PV	Max. P	Max. V
BEAR-N-BRONZ	75,000	3,000	750
BOST-BRONZ	50,000	2,000	1,200
BOST-BRONZ (Thrust Washers)	10,000	2,000	1,200
F1	20,000	1,000	400
TN	10,000	800	300
AF	8,000	750	300
GS	4,000	500	300
D	3,000	480	300
N	3,000	480	300
UHMW-PE	2,300	1,400	100
Nyloil	16,000	2,000	400
UHMW-PE with Internal Wear Strip	4,000	1,400	100
Nyloil with Internal Wear Strip	16,000	2,000	400

All values based on 72°F ambient temperature and standard lubricant, when required.

NOTE: Above figures should be considered maximum and not to be exceeded.

EXAMPLE

Select a BOST-BRONZ (oil impregnated) bearing to satisfy the following conditions.

Known—

5/8" Shaft Diameter

$$n = 500 \text{ RPM}$$

$$W_1 = \text{Load Bearing I} = L_1 = 52.5 \text{ Lbs.}$$

$$W_2 = \text{Load Bearing II} = L_{II} = 157.5 \text{ Lbs.}$$

L = Length of Bearing

For Bearing I—

$$\begin{aligned} PV &= \frac{.262 \times W_1 \times n}{L \text{ (In. of Lgth)}} \\ &= \frac{.262 \times 52.5 \times 500}{1} \\ &= 6877 \end{aligned}$$

For Bearing II—

$$\begin{aligned} PV &= \frac{.262 \times W_2 \times n}{L \text{ (In. of Lgth.)}} \\ &= \frac{.262 \times 157.5 \times 500}{1} \\ &= 20632 \end{aligned}$$

With the calculated PV of 6877, Bearing I, and 20,632, Bearing II, it can be seen from the Table, that a BOST-BRONZ bearing, one inch long, will not exceed Maximum PV.

NOTE: An increase in L will decrease the value of PV; conversely, a shortening of L increases the value of PV.

A check of PV calculations should now be performed to assure that Max. "P" and Max. "V" is not exceeded.

$$PV \text{ Max.} = P \text{ Max.} \times V \text{ Max.}$$

$$\begin{aligned} V &= .262 \times \text{Shaft Dia.} \times n \\ &= .262 \times .625 \times 500 = 81.9 \end{aligned}$$

$$\text{Bearing I} \quad P = \frac{PV}{V} = \frac{6877}{81.9} = 83.9$$

$$\text{Bearing II} \quad P = \frac{PV}{V} = \frac{20632}{81.9} = 251.9$$

As can be seen, we have not exceeded any maximum values. We can now select an actual Bost-Bronz bearing.

Knowing:

$$\text{Shaft Dia. } 5/8" = \text{Bearing I.D. } 5/8"$$

Bearing O.D. should be approximately 25% larger than I.D.

$$\text{Bearing O.D.} = .625 \times 1.25 = .781"$$

Referring to Bost-Bronz listings, Page 12, we find 5/8" I.D. bearings listed with O.D.'s from 3/4 to 1" and lengths from 1/2 to 2".

From this selection of bearings, we may choose a bearing to fit the requirements.

Since Bearing I is lightly loaded, for practical reasons, we select a bearing length of one times bearing I.D. We select a B1013-5 (5/8" I.D. x 13/16 O.D. x 5/8" long).

Sleeve Bearing Selection (Continued)

EXAMPLE (Continued):

For Bearing II we will select a length of two times bearing I.D. — B1013-10. (In actual practice, it may be more suitable to select one common size — B1013-10.)

For a double-check of PV, we should use actual bearing selected:

$$PV \text{ Actual} = \frac{PV}{L (\text{Actual Bearing})}$$

$$\text{Bearing I PVA} = \frac{6877}{.625} = 10043$$

$$\text{Bearing II PVA} = \frac{20632}{1.25} = 16505$$

Actual PV values are below Maximum PV values shown in Table.

Sleeve Bearing Wear Life

Wear life cannot be applied to BOST-BRONZ (oil-impregnated) or BEAR-N-BRONZ (SAE CA932/660) bearings. Under ideal conditions the shaft rides on a film of oil, and will give almost infinite life. If this film of oil is disrupted, intimate metal-to-metal contact results leading to eventual failure.

Non-Metallic and Non-Lubricated Bearings

Wear rate is generally defined as the volumetric loss of material over a unit of time. Several mechanisms operate simultaneously to remove material from the wear interface, however, the primary mechanism is adhesive wear which is characterized by fine particles of polymer being removed from the surface. The presence of this powder is a good indication that the rubbing surfaces are wearing properly. The presence of melted polymer or large gouges or grooves at the interface is normally an indication that the materials are abrading and wearing and/or the pressure velocity limits of the materials are being exceeded.

Once a Wear Rate factor (K) has been established it can be used by the engineer to calculate wear rates of bearings, gears, etc. However, because wear rates is affected by material types, finishes and hardness as well as environmental temperature and part design, large errors may result as end use variables begin to differ from those selected for the test procedure.

As a relative measure of the performance of one composite vs. another at the same operating conditions, the K factors have proven to be highly reliable.

$$t = K (PVT)$$

t = Wear in inches

$$P = \frac{W (\text{Total Load})}{A (\text{Brg. I.D.} \times \text{Lgth.})}$$

V = Velocity in ft. per minute
(.262 x RPM x Shaft Dia.)

$$T = \frac{t}{KPV}$$

T = Running time in hours

K = Wear rate factor

		K
Delrin or Celcon	(D)	50×10^{-10}
Nylatron GS . . .	(GS)	35×10^{-10}
Teflon filled Acetal	(AF)	17×10^{-10}
Teflon filled Nylon	(TN)	13×10^{-10}
Glass Filled Teflon (F-1)		12×10^{-10}
Nylon		12×10^{-10}

Values for plastic resins assume no trace of lubricant present.

A simple calculation could be made as follows:

- Assumptions:
1. 1616D-1/2 Delrin Roll End Bearing
 2. .020 inch allowable wear limit
 3. 50 lbs. load on roll (25 lbs. per bearing)
 4. 100 RPM
 5. Normal environment with no lubrication

Problem: Find estimated wear life

Solution:

$$PV = \frac{\pi W n}{12 L} = \frac{\pi \times 25 \times 100}{12 \times 1} = 655$$

$$t = K (PVT)$$

$$T = \frac{t}{KPV} \text{ or } \frac{.020}{50 \times 10^{-10}} \times 655$$

$$T = 6100 \text{ hrs.}$$

The use of low viscosity lubricant applied initially and/or periodically during operation of the bearing would extend the life several times.

BostonE F-1 material is generally limited to a bearing maximum of 1,000 p.s.i. For more detailed design calculations Fig. 2 shows actual deformation values as a function of temperature and load.

The coefficient of friction of BostonE F-1 varies with changes in load and speed when operated dry. Figure 3 shows the variation with load and Figure 4 shows the variation with speed.

Sleeve Bearing Wear Life (Continued)



For optimum performance of BostonE F-1 bearings, the mating surface should be as hard as possible. Mild steel, however, will give satisfactory results.

A surface finish range of 8-16 micro-inches is preferred; however, good results will be obtained with finishes to 32 micro-inches.

Figures 1 through 6 apply to BostonE F-1 material only.

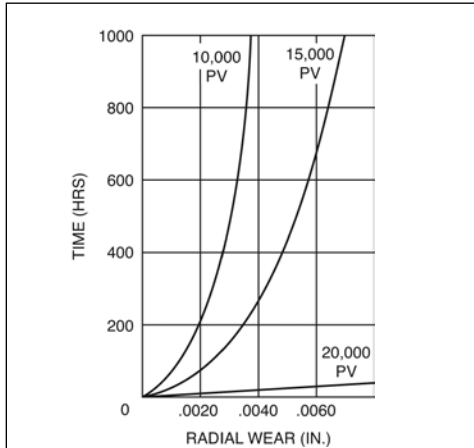

FIGURE 1 – TIME VS. RADIAL WEAR (UNLUBRICATED)

Load (psi)	Deformation (%)	
	78°F	300°F
250	.1	.4
500	.3	1.4
750	.5	2.9
1000	.8	—
1250	1.1	—
1500	1.6	—

FIGURE 2 – DEFORMATION UNDER LOAD

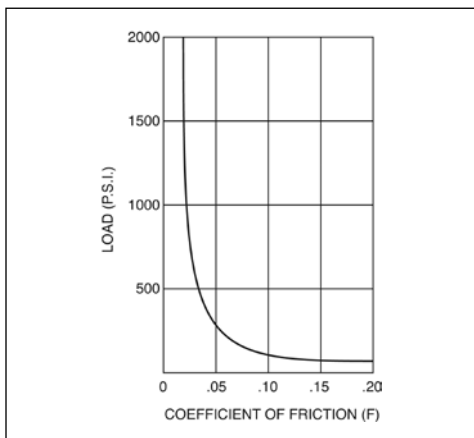

FIGURE 3 – LOAD VS. FRICTION

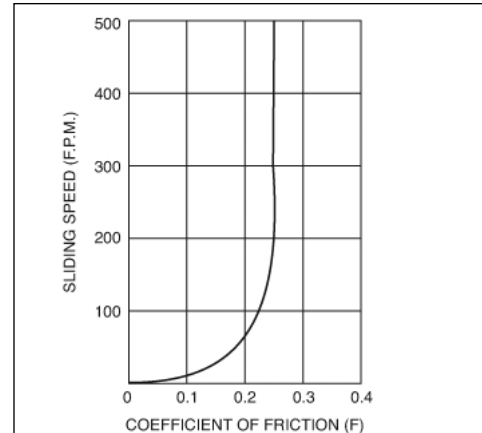

FIGURE 4 – SPEED VS. FRICTION

Coefficient of Friction

Shaft Material	
Hardened Steel	0.15
Stainless Steel	0.15
Chromium Plated Steel	0.16
Cast Iron	0.19
Hard Anodized Aluminum	0.20
Monel	0.23
Cold Rolled Steel	0.25
*Brass	0.33
*Aluminum	0.35

*High rate of shaft wear

FIGURE 5 – EFFECT OF MATING SURFACES WITH BOSTONE F-1

Coefficient of Expansion

Temperature Range	C.D. (all values are x 10 ⁻⁵)	M.D.
+68°F. to -400°	-1.8	-3.5
+68°F. to -300°	-2.3	-4.0
+68°F. to -200°	-2.9	-4.3
+68°F. to -100°	-3.5	-4.8
+68°F. to 0°	-4.4	-5.9
+68°F. to +78°	12	25
(approximate data)		
+78°F. to +100°	3.5	6.0
+78°F. to +200°	3.5	6.2
+78°F. to +300°	3.6	7.0
+78°F. to +400°	4.2	7.8
+78°F. to +500°	5.0	8.5

M.D. = Molded Direction (parallel to length of molded or extruded rod or tube)

C.D. = Cross Direction (perpendicular to length of molded or extruded rod or tube)

All tubes are approximately ± 5%.

FIGURE 6 – COEFFICIENT OF LINEAR THERMAL EXPANSION

Engineering Information

Lubrication – BOST-BRONZ

All standard BOST-BRONZ bearings, bars and plates are impregnated with a high grade, oxidation-resistant mineral oil of SAE30 (ISO 100) viscosity. If properly stored, BOST-BRONZ parts retain their oil supply indefinitely. To prevent loss of lubricant, BOST-BRONZ should be stored in non-absorbent materials (metal, plastic, or suitably lined containers, etc.) The bearings should be covered to keep out dirt and dust.

REMOVING LUBRICANT: If it becomes necessary to remove the oil from BOST-BRONZ, for example to replace with another type or viscosity of lubricant, the following procedure may be used:

Immerse parts in a good grade of oil solvent, such as lead-free gasoline, naphtha, carbon tetrachloride or alcohol. Change solvent often, until solvent appears clear. Agitation will hasten the process.

RE-OILING: BOST-BRONZ parts may be re-impregnated by submerging in oil (pre-heated to about 150°F) for approximately 30 minutes. More time should be allowed for larger parts.

Supplementary Lubrication

The following designs illustrate simple, effective arrangements for providing supplementary lubrication.

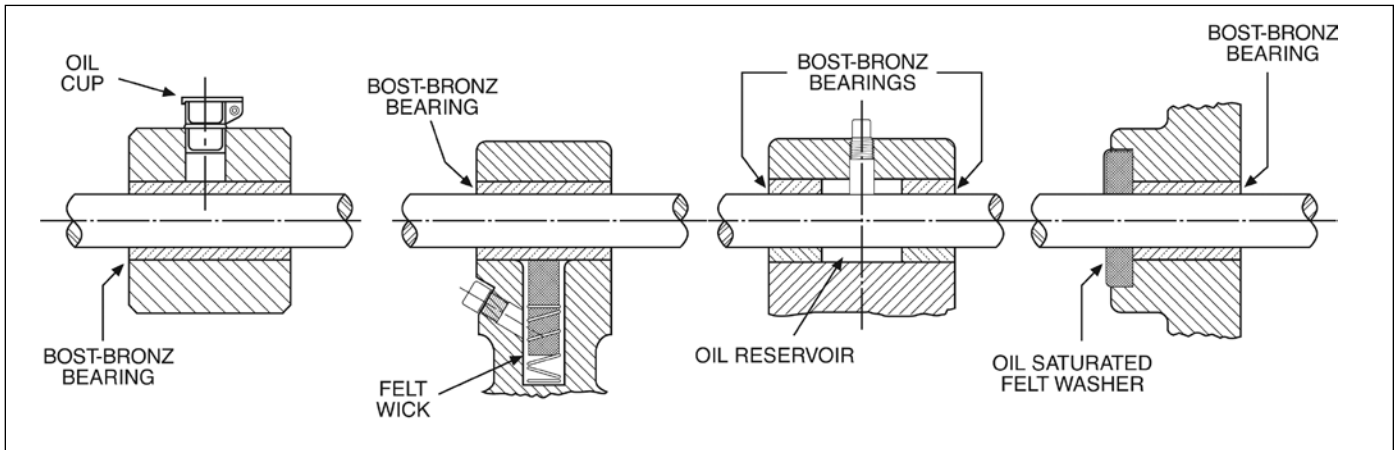

Lubrication – BEAR-N-BRONZ

The maintenance of an oil film between the shaft and bearing surfaces is extremely important, serving to reduce friction, dissipate heat, and retard wear by minimizing any metal to metal contact.

Lubricant is usually supplied into the bearing from an oil cup or fitting through an oil hole.

The drawings below illustrate two typical methods.

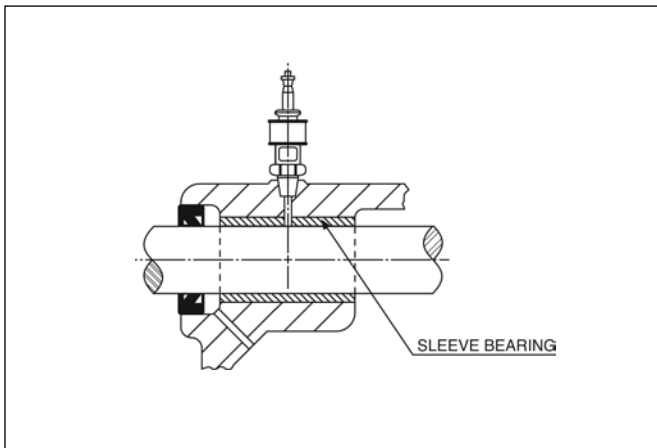

A. Oil Cup

Oil is fed from the oil cup to the bearing by gravity.

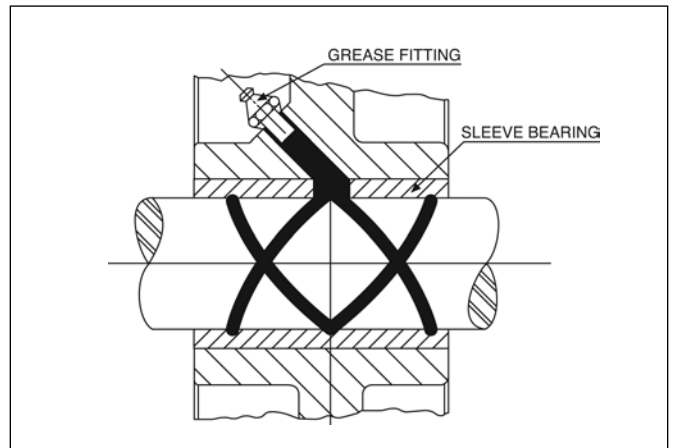

B. Oil or Grease Fitting

Lubricant is fed through the fitting under pressure and distributed through grooves by the rotation of the shaft.

Lubrication – BEAR-N-BRONZ (Continued)

Grooving

1. An oil feeder hole is normally sufficient for small bearings under light loads.

The oil hole should be in a position to introduce the lubricant to the non-loaded area of the bearing. The lubricant will then normally be carried to the loaded area by the rotation of the shaft.

For larger bearings under heavy loads, it may be desirable to facilitate the flow of lubricant to the pressure area by means of grooves machined into the bearing surface.

2. Type I or Type II grooves have proven adequate for most applications requiring an oil groove. In either case, the oil feed hole introducing the lubricant should always be located in the unloaded bearing area.

3. Very long bearings may require two feeder holes connected by one straight (axial) groove.

4. Oil grooves should stop short of the bearing ends to minimize oil leakage.

5. Grease lubricants are normally restricted to applications subjected to heavy loads at low speeds. Grease should be distributed under pressure along oil grooves to the loaded area. Type VI or Type VII grooves may be used for grease lubrication.

Below are illustrations of some popular styles of oil grooves:

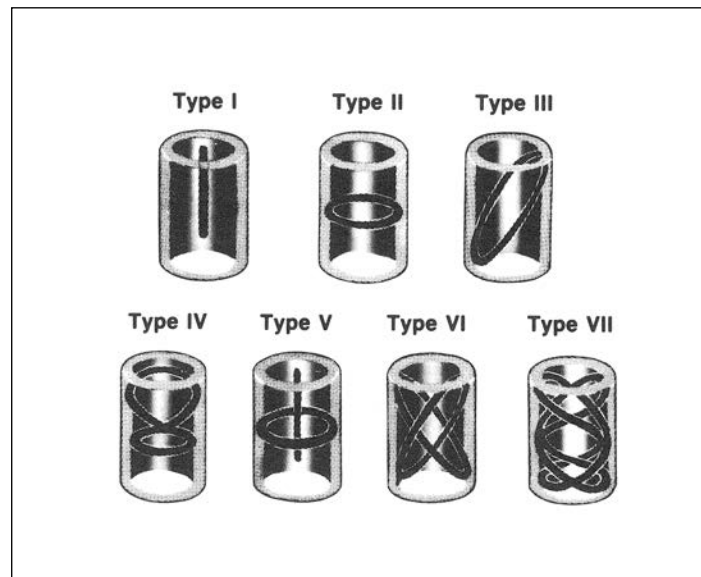

Depth of oil groove is 1/8" max. if wall permits. On thin wall bearings depth of groove is normally less than 1/2" wall thickness. When applicable groove is located 1/8" from ends.

Shaft Clearances

The following graphs may be used as a guide to determine shaft clearance for proper running fit.

F

BOST-BRONZ

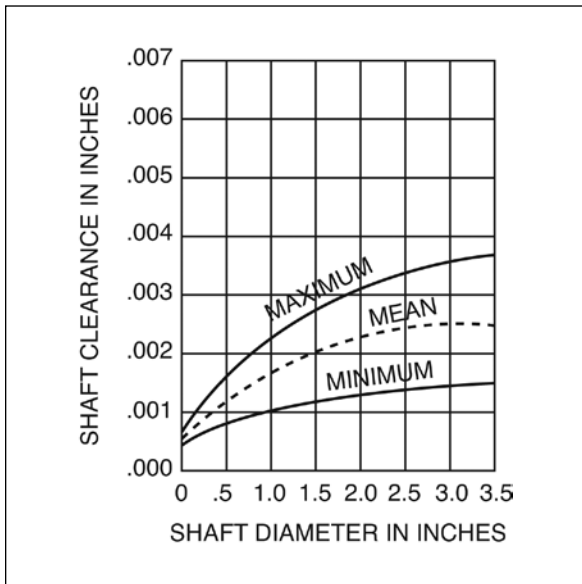

BEAR-N-BRONZ

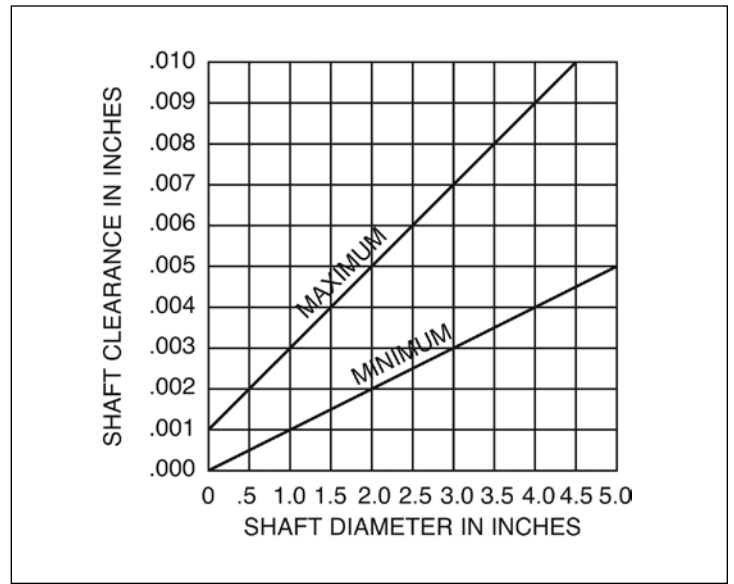

Plastics

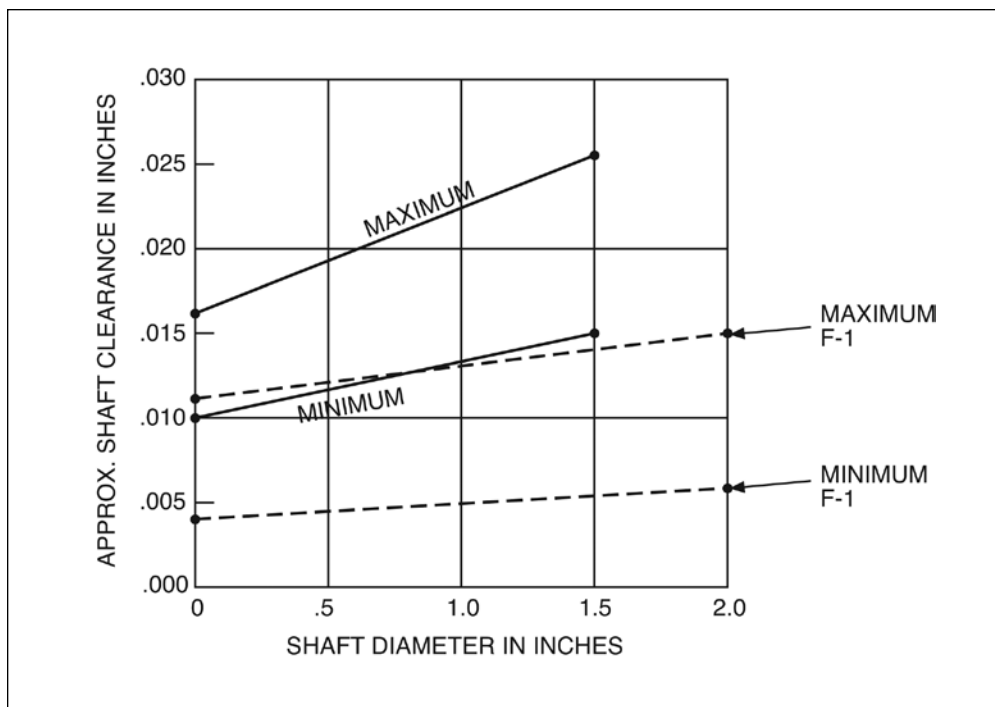

The allowance for press fit into a housing will vary depending upon bearing size, wall thickness, housing material, and housing construction. The accompanying graphs will be a useful guide in determining allowances for press fits.

BEAR-N-BRONZ

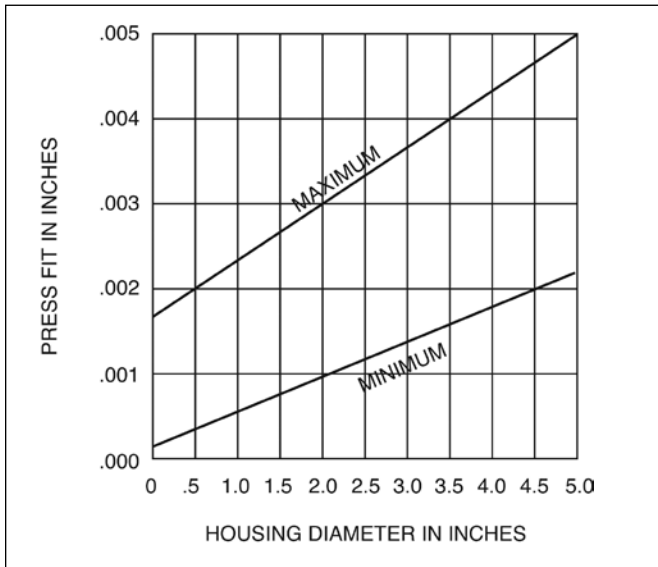

BOST-BRONZ

When a BOST-BRONZ bearing is pressed into a housing, the inside diameter (I.D.) will close-in (becoming smaller). The amount will depend upon the same factors influencing the Press Fit, but will average approximately 75% of the Press Fit allowance.

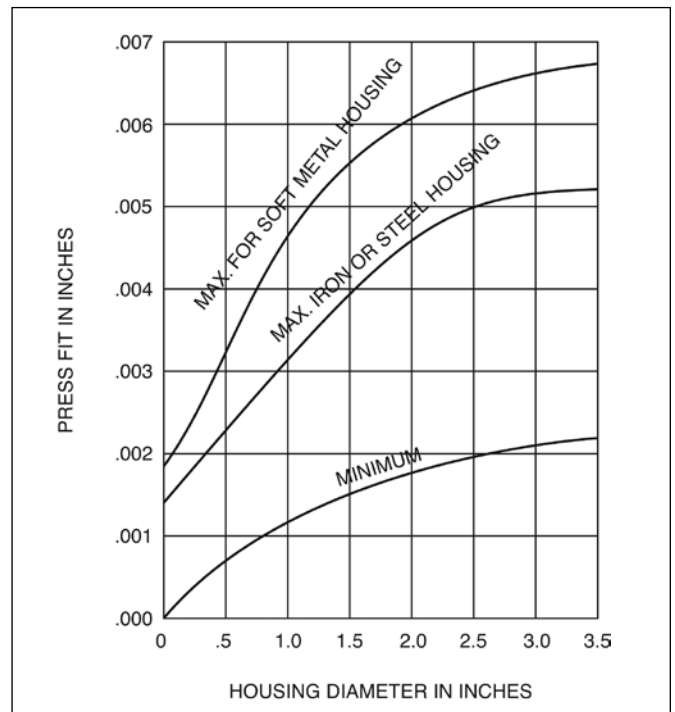

Plastics

Due to normal variations in molded bearings, practicality dictates the measuring of actual bearing O.D. and adjusting bore size accordingly.

For this reason, the minimum required press fit depicted in graph, for F-1 material and other plastic material is approximate and may be used as a guide.

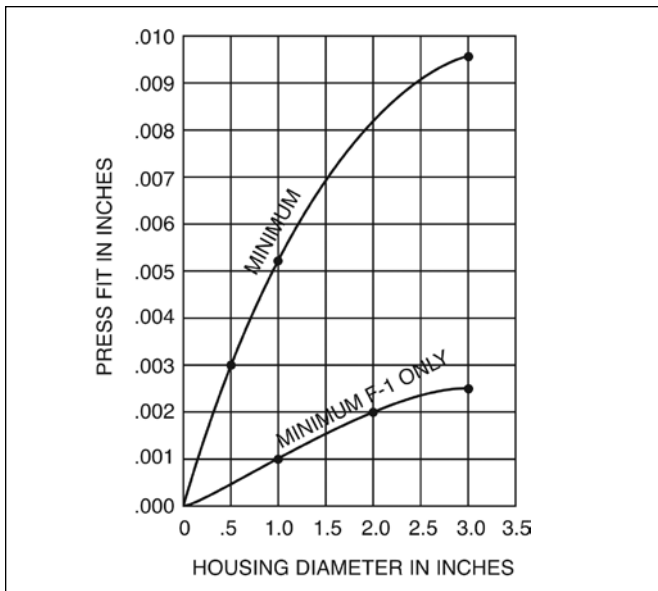

Machining

In cases where it is desired to alter a standard stock bearing or to manufacture parts from a bronze bar or plate stock, the following machining practices are suggested.

BOST-BRONZ

BOST-BRONZ may be readily machined. For best results, use carbide tools. For finishing cuts on bearing surfaces, the cutting tool should be extremely sharp. Use feeds and speeds that are normal for machining regular bronze. Finish with a light cut (up to .005"). This method avoids the pulling or spreading of metal over the surface pores. Cutting oils or coolants should not be used. After machining, parts should be reoiled, using a good grade of oxidation-resistant mineral oil of about SAE20 (ISO 68) viscosity. For re-oiling procedure, see lubrication, Page 178.

Assembly and Sizing – BOST-BRONZ

In most instances, sizing the bore of BOST-BRONZ bearing is not necessary. The desired inside diameter will be obtained by proper press fit (and close-in) at assembly. In applications where sizing is necessary, it may be accomplished during assembly by the use of a shouldered arbor, as illustrated in Figure 1. The arbor should be ground and lapped to a size slightly larger (.0002" to .0003" approx.) than the hole desired. A multiple step burnishing tool (see Figure 2) may also be used to size the hole in BOST-BRONZ bearings after assembly.

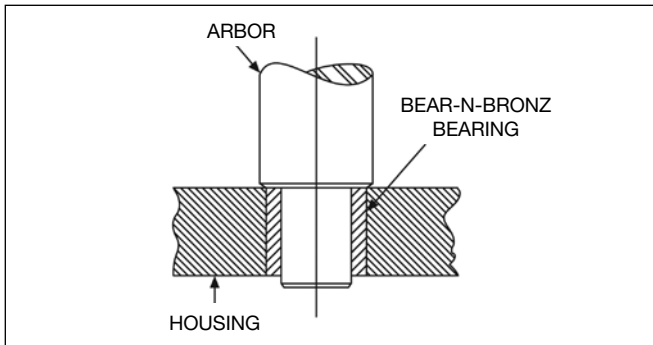

FIGURE 1.

BEAR-N-BRONZ

The use of carbide tools or high speed tools is recommended for machining Bear-N-Bronz. Carbide tools should be used at speeds of 500 to 1000 surface feet per minute. High speed steel tools should be used to 200 to 500 surface feet per minute. Either tool should be held to a minimum clearance angle for best results. Cutting solutions are not required.

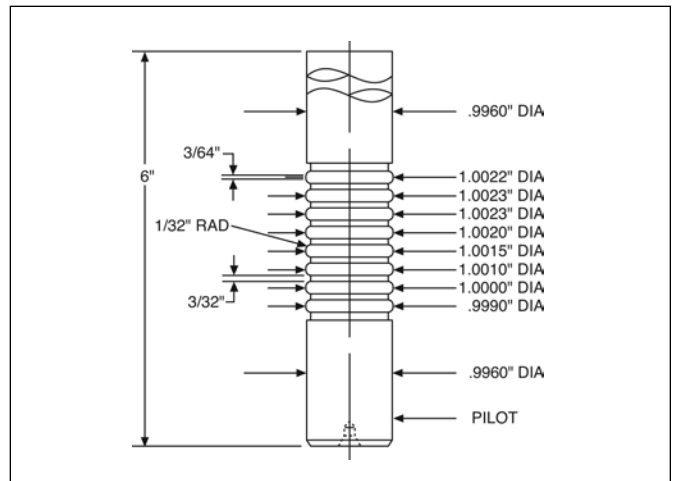
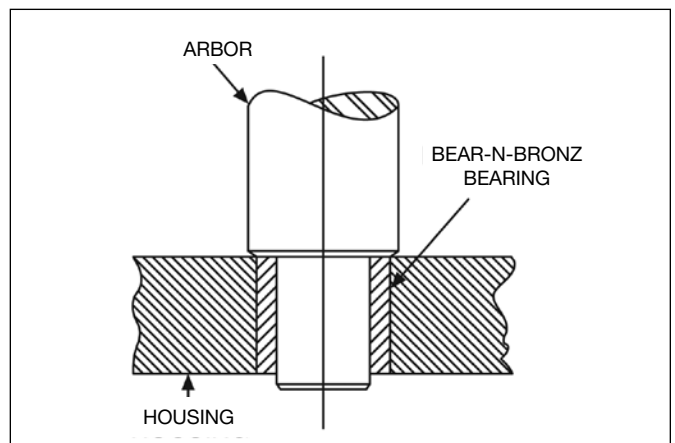

FIGURE 2.

Assembly – BEAR-N-BRONZ

BEAR-N-BRONZ can be easily assembled by using a shouldered arbor, as illustrated, to maintain proper bearing alignment. A steady, even pressure should be applied. The arbor diameter should be of a size to allow for close-in of bearing I.D. at assembly. The surface of the arbor should be lightly oiled to facilitate withdrawal after assembly.





Boston Gear's line of unmounted, inch size ball bearings, rod ends, spherical and linear bearings, give the designer freedom to choose from a wide range of quality bearing products that will resolve numerous application problems.

Boston Gear's inch size ball bearings are offered in Precision Ground, Semi- and Unground Radial and Thrust bearings. Our rod end and linear bearings are offered in Precision and Commercial Series.

Ball Bearings

Boston Ball Bearings provide improved performance over a wide range of operating conditions.

Major features include: Honed raceways on precision ball bearings for maximum life and smoother, quieter operation. Superior, low friction (low torque) seals, to more effectively exclude foreign matter and retain lubricant over a longer period.

The line of Ball Bearings include close tolerance precision units and inexpensive steel assemblies of the semi-ground type. These anti-friction items, available quickly from stock, make it easier to use a superior bearing "exactly right" for the majority of applications.



Anti-Friction Bearings

Ball Bearings (Continued)

F



The bearings listed in this catalog are made from steel of various analyses. Carburizing grades are case hardened to the desired depths and hardness values, insuring high resistance to wear and breakdown. High carbon chrome alloy steels are through hardened. If you have a special material application, Boston Gear engineers will welcome the opportunity to help you make a proper bearing selection.

Bearings in this catalog may be selected according to finish or accuracy: ground bearings are available in the radial and thrust designs primarily. With boundary dimensions and internal fit-up held to exacting tolerances and with ground and polished ball grooves, ground bearings are recommended for applications requiring greater speeds and loads and where quiet accurate operation is essential. Normal tolerance level is .005"/.0010".

Unground bearings are designed for applications where speeds and loads are moderate and the requirements of running accuracy and noise level do not warrant the more expensive ground precision bearing. The three basic design types are available. Normal tolerance level is .005"/.010".

Rod End and Spherical Bearings



Boston Gear's broad line of rod end and spherical bearings serve many markets, which include textile, agriculture and off-highway vehicles along with military.

Anti-Friction Bearings

Nice® 1600 Series® Bearings Radial Ball Bearings; Ground, Single Row



HIGH QUALITY INCH DIMENSIONAL BEARINGS for adaptation to many precision bearing applications. Suitable for speeds in the neighborhood of 5000 R.P.M.

IMPROVED BALL GROOVE FINISH for smoother, quieter operation.

GROUND BORES held to a tolerance of + .0000" to -.0005" on all sizes, 1/4" bore and over.

NYLON BALL RETAINERS (TN) furnished as standard. Steel retainers (J) available on special production order.

GREASE PACKED as standard on Types DC and DS. Types SC, SS and NS can be grease packed on special order.

NYLON SEALS more effectively retain lubricant and exclude foreign matter.

SPECIAL FEATURES including dimensions, tolerances, etc. available on special order.

ORDER BY CATALOG NUMBER OR ITEM CODE

Bore	Double Shield		Double Sealed	
	Catalog Number	Item Code	Catalog Number	Item Code
.2500	1602DS	50724	1602DC	50701
.3125	1603DS	50725	1603DC	50702
.3750	1604DS	50726	1604DC	50703
.3125	1605DS	50727	1605DC	50704
.3750	1606DS	50728	1606DC	50705
.4375	1607DS	50729	1607DC	50706
.3750	1614DS	50730	1614DC	50707
.4375	1615DS	50731	1615DC	50708
.5000	1616DS	50732	1616DC	50709
.4375	1620DS	50733	—	—
.5000	1621DS	50734	1621DC	50710
.6250	1623DS	50736	1623DC	50712
.6250	1628DS	50737	1628DC	50713
.7500	1630DS	50738	1630DC	50714
.6250	1633DS	50739	1633DC	50715
.7500	1635DS	50740	1635DC	50716
.7500	1638DS	50741	1638DC	50717
.8750	1640DS	50742	1640DC	50718
1.0000	1641DS	50743	1641DC	50719
1.1250	1652DS	50744	1652DC	50720
1.2500	1654DS	50745	1654DC	50721
1.2500	1657DS	50746	1657DC	50722

NOTE: Dimensions and load data on next page.

Seal and Shield Arrangements

TYPES SC, SS and NS are available via special order only

DOUBLE SEALED	DOUBLE SHIELD	SINGLE SEAL	SINGLE SHIELD	NO SHIELDS
DC	DS	SC	SS	NS

*All bearings listed are registered Trademarks of RBC Bearings and Roller Bearing Company of America, Inc.

Anti-Friction Bearings

Nice® 1600 Series® Bearings Radial Ball Bearings; Ground, Single Row

F

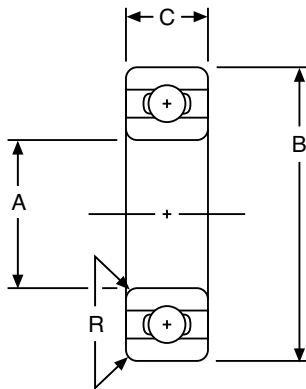

STANDARD TOLERANCES

DIMENSIONS	TOLERANCE
A	2500-1.2500 +.0000 to - .0005
B	.6875-1.7500 2.0000-2.5625 +.0000 to - .0005 +.0000 to - .0006
C	All +.000 to - .005

For recommended shaft and housing fits, see engineering section, page 238.

ALL DIMENSIONS IN INCHES

Basic Bearing No.	A	B	C	R	Balls	
				Radius	No.	Dia.
1602	.2500	.6875	1/4+	.012	6	1/8
1603	.3125	.8750	9/32++	.012	7	5/32
1604	.3750	.8750	9/32++	.015	7	5/32
1605	.3125	.9063	5/16	.012	9	1/8
1606	.3750	.9063	5/16	.015	9	1/8
1607	.4375	.9063	5/16	.015	9	1/8
1614	.3750	1.1250	3/8	.025	7	3/16
1615	.4375	1.1250	3/8	.025	7	3/16
1616	.5000	1.1250	3/8	.025	7	3/16
1620	.4375	1.3750	7/16	.025	8	15/64
1621®	.5000	1.3750	7/16	.025	8	15/64
1623	.6250	1.3750	7/16	.025	8	15/64
1628	.6250	1.6250	1/2	.025	8	1/4
1630®	.7500	1.6250	1/2	.025	8	1/4
1633	.6250	1.7500	1/2	.025	8	1/4
1635®	.7500	1.7500	1/2	.025	8	1/4
1638	.7500	2.0000	9/16	.035	10	1/4
1640	.8750	2.0000	9/16	.035	10	1/4
1641®	1.0000	2.0000	9/16	.035	10	1/4
1652	1.1250	2.5000	5/8	.035	10	5/16
1654	1.2500	2.5000	5/8	.035	10	5/16
1657	1.2500	2.5625	11/16	.035	9	3/8

*Maximum fillet on shaft or in housing which bearing corner will clear.
+ Width SC & DC = 5/16"
++ Width SC & DC = 11/32"

Load Data

The indicated load ratings are based on 2500 hours average life. (L_{50}) to determine the load ratings at 3500 and 5000 hours, 90 percent and 80 percent respectively, of the above ratings should be used.

Basic Bearing Number	Radial Capacity (Lbs.)								Limiting Thrust (Lbs.)
	Revolutions Per Minute								
	50	100	300	500	1200	1800	2500	5000	
1602	230	185	130	110	80	70	65	50	42
1603	380	300	210	175	130	115	105	80	75
1604	380	300	210	175	130	115	105	80	75
1605	305	245	170	140	105	95	85	65	65
1606	305	245	170	140	105	95	85	65	65
1607	305	245	170	140	105	95	85	65	65
1614	530	420	290	245	185	160	145	115	110
1615	530	420	290	245	185	160	145	115	110
1616	530	420	290	245	185	160	145	115	110
1620	860	690	475	400	300	260	235	185	200
1621®	860	690	475	400	300	260	235	185	200
1623	860	690	475	400	300	260	235	185	200
1628	980	780	540	460	340	300	265	210	225
1630®	980	780	540	460	340	300	265	210	225
1633	980	780	540	460	340	300	265	210	225
1635®	980	780	540	460	340	300	265	210	225
1638	1140	905	630	530	395	345	310	245	280
1640	1140	905	630	530	395	345	310	245	280
1641®	1140	905	630	530	395	345	310	245	280
1652	1695	1345	935	790	590	515	460	365	440
1654	1695	1345	935	790	590	515	460	365	440
1657	2200	1750	1215	1025	765	665	600	475	570

*All bearings listed are registered Trademarks of RBC Bearings and Roller Bearing Company of America, Inc.

Anti-Friction Bearings

Nice® 7500 Series® Bearings Radial Ball Bearings; Ground, Single Row

NYLON BALL RETAINERS (TN) standard on all sizes.

SINGLE LIP CONTACT SEALS effectively retain lubricant and exclude foreign material.

GREASE PACKED as standard on all “Double Sealed” Type DL and DLG.

SPECIAL FEATURES including dimensions, tolerances, single or without seals, steel retainers available on special order if quantity warrants.

SNAP RINGS included on all Type DLG sizes. Type DL sizes include snap ring groove but no snap rings furnished.

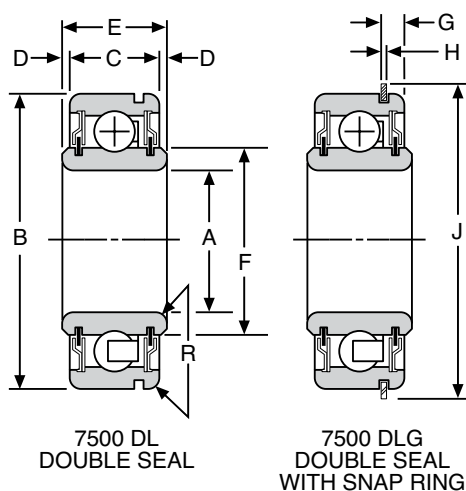

STANDARD TOLERANCES

DIMENSIONS	TOLERANCE
A	All +.0000 to -.0005
B	1.7500 2.0000-2.5625 +.0000 to -.0005 +.0000 to -.0006
C	All +.000 to -.005
E	All +.000 to -.005
G	All ±.005

ALL DIMENSIONS IN INCHES ORDER BY CATALOG NUMBER OR ITEM CODE

A	B	C	D	E	F	G	H	J	R Radius *	Balls		DL Series		DLG Series	
										No.	Dia.	Catalog Number	Item Code	Catalog Number	Item Code
.5000 .6250 .7500	1.7500	5/8	1/16	3/4	.993	.136	.042	1-59/64	.035	8	1/4	7508DL 7510DL 7512DL	50587 50588 50589	7508DLG 7510DLG 7512DLG	50581 50582 50583
1.0000 1.2500	2.0000 2.5625	5/8 3/4	1/16 1/16	3/4 7/8	1.290 1.631	.136 .190	.042 .065	2-5/32 2-49/64	.035 .035	10 9	1/4 3/8	7516DL 7520DL	50591 50592	7516DLG 7520DLG	50585 50586

*Maximum fillet on shaft or housing which bearing will clear.

For recommended shaft and housing fits, see engineering section, page 238.

Load Data

The indicated load ratings are based on 2500 hours average life (L₅₀). To determine the load ratings at 3500 and 5000 hours, 90 percent and 80 percent respectively, of the above ratings should be used.

Basic Bearing Number	Radial Capacity (Lbs.)										Max. Thrust Lbs.
	Revolutions Per Minute										
	50	100	300	500	1000	1200	1800	2500	3600	5000	
7508-7512	1180	940	650	550	435	410	360	320	285	255	340
7516	1365	1085	750	635	505	475	415	370	330	295	375
7520	2640	2100	1460	1230	975	915	805	715	635	570	740

*All bearings listed are registered Trademarks of RBC Bearings and Roller Bearing Company of America, Inc.

Anti-Friction Bearings

Nice® 7600 Series® Bearings

Radial Ball Bearings; Ground, Single Row; Extended Inner Race



NYLON BALL RETAINERS (TN) standard on all sizes.

SINGLE LIP CONTACT SEALS effectively retain lubricant and exclude foreign material.

GREASE PACKED as standard on all "Double Sealed" Type DL and DLG.

SPECIAL FEATURES including dimensions, tolerances, single or without seals, steel retainers available on special order if quantity warrants.

SNAP RINGS included on all Type DLG sizes. Type DL sizes include snap ring groove but no snap rings furnished.

STANDARD TOLERANCES

DIMENSIONS	TOLERANCE
A	All +.0008 to -.0000
B	1.7500 2.0000-2.5625 +.0000 to -.0005 +.0000 to -.0006
C	All +.000 to -.005
E	All +.000 to -.005
G	All ±.005
K	All +.000 to -.005

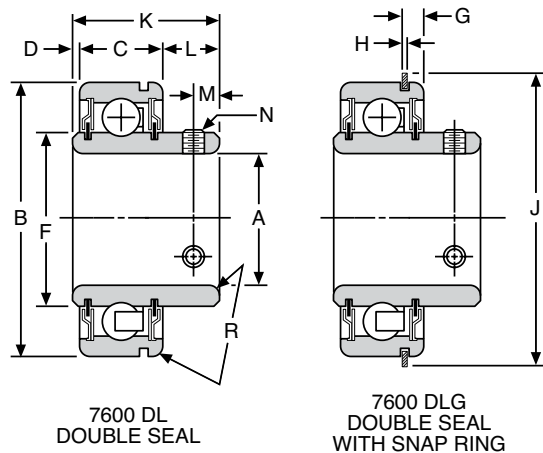

ALL DIMENSIONS IN INCHES ORDER BY CATALOG NUMBER OR ITEM CODE

A	B	C	D	F	G	H	J	K	L	M	N	R* Radius	Balls		DL Series		DLG Series	
													No.	Dia.	Catalog Number	Item Code	Catalog Number	Item Code
.6250 .7500	1.7500	5/8	1/16	.993	.136	.042	1-59/64	1.092	.405	.233	10-32	.035	8	1/4	7610DL 7612DL	50600 50601	7610DLG 7612DLG	50594 50595
1.0000	2.0000	5/8	1/16	1.290	.136	.042	2-5/32	1.179	.492	.261	10-32	.035	10	1/4	7616DL	50603	7616DLG	50597
1.2500	2.5625	3/4	1/16	1.631	.190	.065	2-49/64	1.417	.605	.261	1/4-28	.035	9	3/8	7620DL	50604	7620DLG	50598

*Maximum fillet on shaft or housing which bearing will clear.

For recommended shaft and housing fits, see engineering section, page 238.

Load Data

The indicated load ratings are based on 2500 hours average life (L₅₀). To determine the load ratings at 3500 and 5000 hours, 90 percent and 80 percent respectively, of the above ratings should be used.

Basic Bearing Number	Radial Capacity (Lbs.)										Max. (Lbs.)
	Revolutions Per Minute										
	50	100	300	500	1000	1200	1800	2500	3600	5000	
7610-7612	1180	940	650	550	435	410	360	320	285	255	340
7616	1365	1085	750	635	505	475	415	370	330	295	375
7620	2640	2100	1460	1230	975	915	805	715	635	570	740

*All bearings listed are registered Trademarks of RBC Bearings and Roller Bearing Company of America, Inc.

Anti-Friction Bearings

Nice® 6900 Series® Bearings

Radial Ball Bearings; Ground, Single Row; Flange Mounted

AVAILABLE AS COMPLETE ASSEMBLY, BEARING only or HOUSING only.

INNER RACE includes 2 setscrews.

GREASE PACKED, COMPOSITION SEALED.

NYLON RETAINERS (TN) furnished as standard.

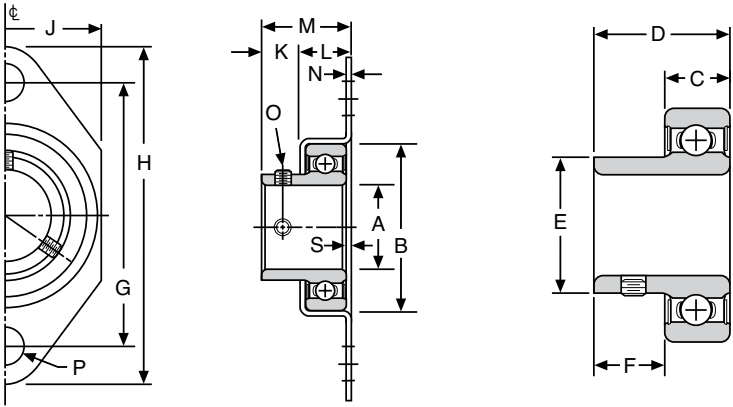

ASSEMBLY

BEARING ONLY

STANDARD TOLERANCES

DIMENSIONS		TOLERANCE
A	All	+0.005 to -0.000
B	.9062-1.6250	+0.0000 to -0.0005
	2.000	+0.0000 to -0.0006
C	All	+0.000 to -0.005

**ALL DIMENSIONS IN INCHES
ORDER BY CATALOG NUMBER OR ITEM CODE**

A	B	C	D	E	F	G Bolt Ctrs.	H	+ J	K	L	M	N	O	P	S	Assembly*		Bearing Only	
																Catalog Number	Item Code	Catalog Number	Item Code
.3750	.9062	5/16	11/16	.555	3/8	1-7/8	2-1/2	1-1/8	11/32	11/32	11/16	.035	8-32	5/16	.000	6906	50572	6906B	50571
.5000 .6250	1.6250	1/2	1	.995	1/2	2-7/8	3-3/4	1-7/8	7/16	11/16	1	.062	1/4-28	7/16	.010	6908 6910	50574 50576	6908B 6910B	50573 50575
.7500 1.0000	2.0000	9/16	1-1/16	1.293	1/2	3-1/4	4-1/8	2-1/4	7/16	11/16	1-1/8	.062	1/4-28 10-32	7/16	1/16	6912 6916	50578 50580	6912B 6916B	50577 50579

*Housings do not have Catalog Numbers. To order specify bearing size-housing. Example: 6906-Housing.
+ J dimension is the overall width.

Basic Bearing Number	Radial Capacity (Lbs.) Revolutions Per Minute			
	50	100	500	1800
6906	305	245	140	95
6908-6910	735	585	340	225
6912	850	675	395	260
6916	1140	905	530	345

Load Data

The indicated load ratings are based on 2500 hours average life (L₅₀). To determine the load ratings at 3500 and 5000 hours, 90 percent and 80 percent respectively, of the above ratings should be used.

*All bearings listed are registered Trademarks of RBC Bearings and Roller Bearing Company of America, Inc.

Anti-Friction Bearings

Nice® 3000 Series® Bearings

Radial Ball Bearings; Semi-Ground, Single Row



LOW COST INCH DIMENSIONAL BEARINGS similar to 1600 Series in construction and dimensions and suitable for speeds up to 2500 R.P.M.

NYLON BALL RETAINERS (TN) furnished as standard. Steel retainers (J) available on special production order.

GREASE PACKED as standard on Types DC and DS. Types SC, SS and NS can be grease packed on special order.

NYLON SEALS more effectively retain lubricant and exclude foreign matter.

SPECIAL FEATURES including dimensions, tolerances, etc. available on special order.

ORDER BY CATALOG NUMBER OR ITEM CODE

Bore	Double Shield		Double Sealed	
	Catalog Number	Item Code	Catalog Number	Item Code
1/4	3002DS	50768	3002DC	50749
3/8	3004DS	50770	—	—
3/8	3014DS	50774	3014DC	50755
1/2	3016DS	50776	3016DC	50757
1/2	3021DS	50778	3021DC	50758
5/8	3023DS	50779	3023DC	50759
5/8	3028DS	50780	3028DC	50760
3/4	3030DS	50781	3030DC	50761
3/4	3035DS	50783	3035DC	50763
1	3041DS	50786	3041DC	50766

Seal and Shield Arrangements

DOUBLE SEALED	DOUBLE SHIELD	SINGLE SEAL	SINGLE SHIELD	NO SHIELDS
DC	DS	SC	SS	NS

TYPES SC, SS and NS are available via special order only.

*All bearings listed are registered Trademarks of RBC Bearings and Roller Bearing Company of America, Inc.

Anti-Friction Bearings

Nice® 3000 Series® Bearings Radial Ball Bearings; Semi-Ground, Single Row

ALL DIMENSIONS IN INCHES

Basic Bearing Number	A	B	C	R * Radius	Balls	
					No.	Dia.
3002	1/4	11/16	1/4+	.012	6	1/8
3004	3/8	7/8	9/32**	.012	7	5/32
3014 3016	3/8 1/2	1-1/8	3/8	.025	7	3/16
3021 3023	1/2 5/8	1-3/8	7/16	.025	8	15/64
3028 3030	5/8 3/4	1-5/8	1/2	.025	8	1/4
3035	3/4	1-3/4	1/2	.025	8	1/4
3040 3041	7/8 1	2	9/16	.035	10	1/4

*Maximum fillet on shaft or in housing which bearing corner will clear.

+ Width SC & DC = 5/16"

++ Width SC = 11/32"

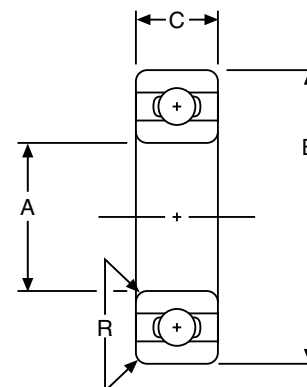

STANDARD TOLERANCES

DIMENSIONS	TOLERANCE
A	All +.005 to -.000
B	11/16-1-3/4 2 +.0000 to -.0005 +.0000 to -.0006
C	All ±.005

For recommended shaft and housing fits, see engineering section, page 244.

Basic Bearing Number	Radial Capacity (Lbs.)					Limiting Thrust (Lbs.)
	Revolutions Per Minute					
	50	100	500	1800	2500	
3002	150	120	70	45	40	30
3004	250	200	120	80	70	50
3014 3016	350	280	165	105	95	75
3021 3023	575	460	270	175	155	135
3028 3030 3035	650	520	305	200	180	150
3040 3041	760	605	355	230	205	185

Load Data

Load ratings are provided only as a guide for bearing selection and are not to be used for life calculation.

Anti-Friction Bearings

Flanged 400F Series

Radial Ball Bearings; Unground, Single Row

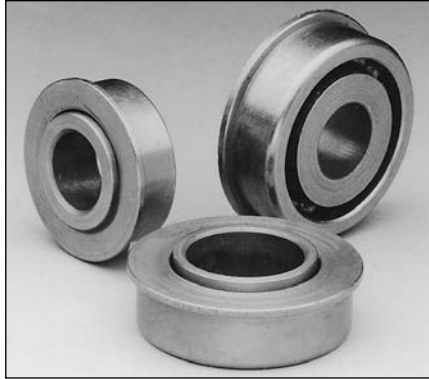

STANDARD TOLERANCES

DIMENSIONS		TOLERANCE
A	All	+0.005 to -0.000
B	All	+0.005 to -0.000
C	All	±0.010

FULL BALL TYPE (V) without retainer.

SUITABLE for SPEEDS up to 1200 RPM.

SOFT STEEL BAND on O.D. permits bearing to be pressed in a housing without the necessity of close housing tolerances.

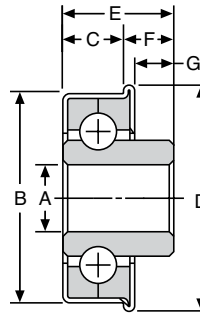

ALL DIMENSIONS IN INCHES
ORDER BY CATALOG NUMBER OR ITEM CODE

A	B	C	D	E	F	G	Balls		Catalog Number	Item Code
							Number	Dia.		
1/4	11/16	13/65	3/4	1/4	3/64	0	10	1/8	5561	50566
3/8	29/32	17/64	1	.350	.088	.048	15	1/8	5543	50565
1/2	1-1/8	.305	1-1/4	7/16	.132	1/16	18	1/8	5491	50564
1/2	1-3/8	11/32	1-1/2	.475	1/8	1/32	15	3/16	5881	50569
5/8	1-3/8	11/32	1-1/2	.475	1/8	1/32	15	3/16	5273	50559
1/2	1-1/2	3/8	1-21/32	11/16	.320	1/4	11	1/4	5327	50561
3/4	1-3/4	.462	1-15/16	37/64	1/8	1/64	14	1/4	5891	50570
3/4	2	13/32	2-1/8	9/16	5/32	1/16	17	1/4	5875	50568
1	2	13/32	2-1/8	5/8	7/32	1/8	17	1/4	5418	50563

Load Data

Load ratings are provided only as a guide for bearing selection and are not to be used for life calculation.

Basic Bearing Number	Radial Capacity (Lbs.)			
	Revolutions Per Minute			
	50	200	600	1200
5561	110	53	30	21
5543	167	80	45	32
5368-5491	200	96	54	38
5881-5273	375	180	101	71
5327	492	236	132	92
5891	625	300	168	177
5875-5418	757	362	204	142

Typical Application Flanged Series

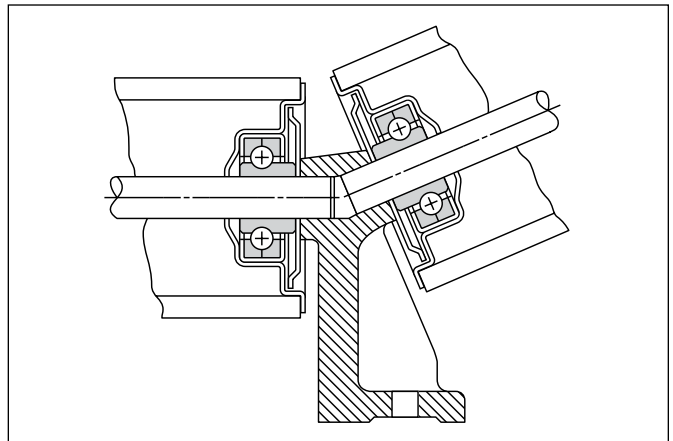

Anti-Friction Bearings

AO/SAO Series Thrust Ball Bearings; Ground, Unbanded

Hardened Alloy Steel — AO Series
Hardened Stainless Steel — SAO Series
FOR LIGHT LOADS

HIGH QUALITY HARDENED STEEL BALLS, retained in a nylon cage.

HARDENED THRUST WASHERS, are ground both sides to provide smooth, flat, parallel ball raceway surfaces.

QUALITY and NUMBER OF BALLS assure high load carrying capacity.

NYLON RETAINER assures minimum frictional losses.

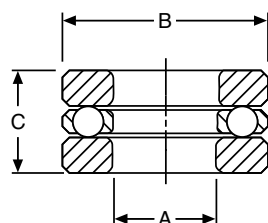

STANDARD TOLERANCES

DIMENSIONS		TOLERANCE
A*	All	+0.002 to +0.007
B	All	+0.000 to -0.005
C	All	+0.000 to -0.010

*AO/SAO 16 +0.002 to +0.010

ALL DIMENSIONS IN INCHES ORDER BY ITEM CODE (2 WASHERS AND 1 NYLON CAGE)

A	B	C	Balls		Basic Bearing Number	AO Series Alloy		SAO Series Stainless Steel	
			Number	Diameter		Washer	Nylon Cage	Washer	Nylon Cage
3/16	7/16	3/16	9	1/16	AO/SAO1	06724	56807	06760	56813
1/4	9/16	7/32	10	3/32	AO/SAO5	06726	56808	06762	56814
5/16	5/8	1/4	10	3/32	AO/SAO8	06728	56809	06764	56815
3/8	11/16	9/32	12	3/32	AO/SAO10	06730	56810	06766	56816
1/2	7/8	3/8	10	1/8	AO/SAO16	06734	56812	06770	56818

Load Data

The indicated load ratings are based on 2500 hours average life (L₅₀). To determine the load ratings at 3500 and 5000 hours, 90 percent and 80 percent respectively, of the above ratings should be used.

Basic Bearing Number	Thrust Capacity (Lbs.)			
	Revolutions Per Minute			
	50	100	500	1000
AO/SAO1	30	25	14	11
AO/SAO5	64	56	31	25
AO/SAO8	68	60	34	27
AO/SAO10	85	72	42	32
AO/SAO16	250	125	70	58

Anti-Friction Bearings

Nice® 600 Series® Bearings Thrust Ball Bearings; Unground, Banded

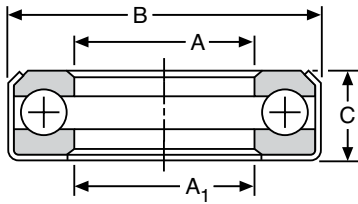

STANDARD TOLERANCES

DIMENSIONS		TOLERANCE
A	All	-.000 to +.010
A ₁	All	±.010
B	All	±.010
C	All	±.010

FULL BALL TYPE (M) without retainer.

ALL DIMENSIONS IN INCHES ORDER BY CATALOG NUMBER OR ITEM CODE

A	A ₁	B	C	Balls		Catalog Number	Item Code
				No.	Dia.		
.250	.275	27/32	.333	10	5/32	601	50537
.375	.400	1-3/64	.359	14	5/32	602	50538
.453	.478	55/64	.281	15	1/8	602-3/4	50540
.500	.525	1-17/64	.437	10	1/4	603	50541
.500	.525	1	.344	12	3/16	603-1/4	50542
.625	.656	1-1/8	.344	16	5/32	605	50543
.625	.656	1-27/64	.456	12	1/4	606	50544
.750	.775	1-21/32	.545	15	1/4	607	50545
.875	.900	1-57/64	.594	17	1/4	608	50547
1.000	1.075	2	.640	12	3/8	609	50548
1.000	1.031	1-31/32	.625	18	1/4	610	50549
1.016	1.031	1-3/4	.625	16	1/4	610-1/4	50550
1.063	1.094	1-31/32	.625	18	1/4	611	50551
1.125	1.150	2-3/32	.625	19	1/4	613	50552
1.457	1.462	2-15/32	.625	23	1/4	619	50555
1.500	1.525	2-19/32	.625	25	1/4	621	50556

Load Data

Load ratings are provided only as a guide for bearing selection and are not to be used for life calculation.

Bearing Number	Thrust Capacity (Lbs.)						Crane Hook
	Revolutions Per Minute						
	10	50	100	250	500	1000	
601	304	246	182	98	71	51	912
602	426	344	254	138	100	71	1277
602-3/4	292	236	174	94	68	48	873
603	780	630	465	252	182	129	2325
603-1/4	526	425	314	170	123	87	1570
605	487	394	291	158	114	81	1460
606	936	750	558	302	218	155	2790
607	1170	945	698	378	273	194	3490
608	1326	1071	791	428	309	220	3960
609	1706	1378	1017	551	398	284	5080
610	1404	1134	837	454	328	233	4190
610-1/4	1248	1008	744	403	291	207	3730
611	1404	1134	837	454	328	233	4190
613	1482	1197	883	479	346	246	4420
619	1794	1449	1069	579	419	298	5350
621	1950	1575	1162	630	455	324	5820

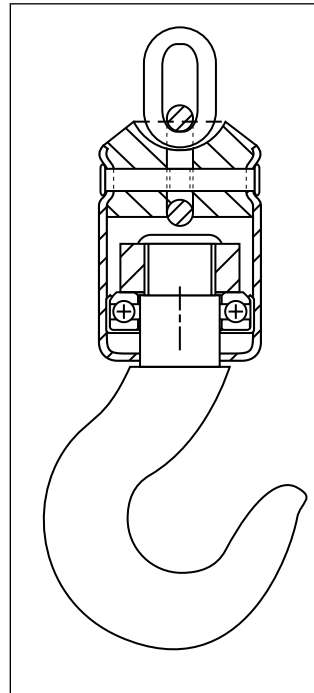

Crane Hook Swivel Application Bearing No. 605

This standard product provided the exact bearing needed by this crane hoist manufacturer. An unground bearing provided the economy, while a full ball complement provided the required high thrust-load capacity. The bearing features a bonded non-separable assembly that provides easy installation and lubrication.

Special platings and stainless steel balls are readily available as a cost-effective way to fight corrosion and increase service life.

*All bearings listed are registered Trademarks of RBC Bearings and Roller Bearing Company of America, Inc.

Anti-Friction Bearings

2000 Series

Ball Bearings Sheaves; Unground

NR 2000 Series are unground, of pressed steel construction with hardened raceways. For rope, wire rope, etc. and special uses requiring a semi-circular tread.

ALL DIMENSIONS IN INCHES
ORDER BY CATALOG NUMBER OR ITEM CODE

.166	1-1/4	9/32	7/16	3/8	1	7/32	NR2000	67135
	1-21/32	5/16	7/16	3/8	1-11/32	7/32	NR2006	67136
1/4	2-7/8	17/32	1/2	1	2-9/16	13/32	NR2008	67137
	3-1/16	37/64	1/2	1	2-9/16	13/32	NR2010	67138
5/16	3	19/32	3/4	1	2-5/8	1/2	NR2011	67139
3/8	2-3/4	1/2	7/16	1	2-3/8	3/8	NR2012	67140
	2-3/4	1/2	9/16	1	2-3/8	3/8	NR2012-1	67141
	2-3/4	9/16	7/16	1	2-3/8	7/16	NR2013	67142
	2-7/8	17/32	1/2	1	2-9/16	13/32	NR2014	67143
	3	1/2	11/16	1	2-3/8	3/8	NR2015	67144
	3-1/16	37/64	1/2	1	2-9/16	13/32	NR2016	67145
	3-5/16	3/4	13/16	13/16	2-3/8	7/16	NR2017	67146
	4-1/16	17/32	3/4	1	3-9/16	13/32	NR2024	67149
1/2	2-7/8	11/16	13/16	13/16	2-1/4	17/32	NR5378	67267
	4-1/16	17/32	3/4	1	3-9/16	13/32	NR2025	67150
5/8	2-3/4	7/16	9/16	13/16	2-3/16	5/16	NR2018	67147
	3	19/32	3/4	1	2-5/8	1/2	NR2020*	67148
1	7-1/8	13/16	5/8	1-3/8	6	17/32	NR5623	67275

* Inner race "D" dimension not centered.

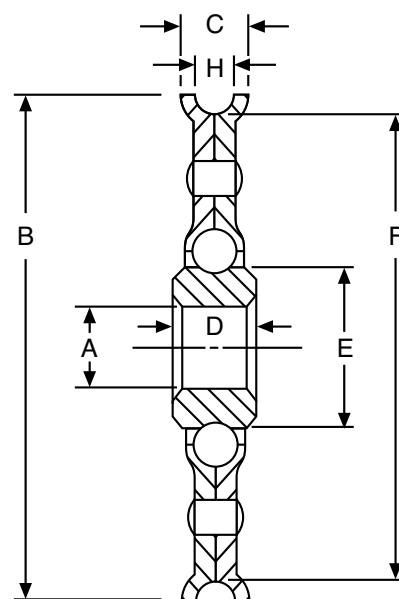

NR2000 NR2006	88	62	42	34	24	19	10	1/8
NR2008 NR2010	300	210	144	116	81	66	14	1/4
NR2011	293	208	146	121	82	70	14	1/4
NR2012 NR2012-1	300	210	144	116	81	66	14	1/4
NR2013	230	164	115	95	65	55	14	1/4
NR2014 NR2015 NR2016 NR2017	300	210	144	116	81	66	14	1/4
NR2024 NR5378 NR2025	471	334	235	194	132	112	15	3/16
NR2018	300	210	144	116	81	66	14	1/4
NR2020 NR5623	293	208	146	121	82	70	19	1/4

Load Data

Load ratings are provided only as a guide for bearing selection and are not to be used for life calculation.

STANDARD TOLERANCES

DIMENSIONS		TOLERANCE
A	All	+ .005 to -.000

Anti-Friction Bearings

2100 Series

Ball Bearings Sheaves; Unground



NR 2100 Series are unground, of pressed steel construction with hardened raceways. For chain or belt application.

ALL DIMENSIONS IN INCHES
ORDER BY CATALOG NUMBER OR ITEM CODE

A	B	C	D	E	F	H	J	Catalog No.	Item Code
.372	2-1/4	19/32	7/8	9/16	1-5/8	15/32	15/32	NR2105	67151
3/8	2-5/8	1/2	5/8	13/16	2	3/8	3/8	NR2106	67152
	3-1/4	19/32	11/16	1	2-11/16	15/32	7/16	NR2111-1	67154
	3-3/8	19/32	11/16	1	2-11/16	15/32	7/16	NR2111	67153
1/2	3-3/8	19/32	7/8	1	2-11/16	15/32	7/16	NR2112	67155
	3	5/8	15/16	1	2-13/16	1/2	1/2	NR2113	67156
	4-15/16	3/4	7/8	1	4	5/8	9/16	NR2118	67157
5/8	4-7/16	5/8	3/4	1	3-7/8	27/64	27/64	NR2120	67158

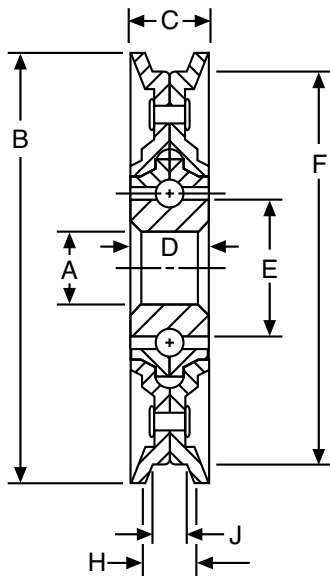

Load Data

Load ratings are provided only as a guide for bearing selection and are not to be used for life calculation.

Sheave Number	Radial Load Capacity in Pounds						Balls	
	Revolutions Per Minute						No.	Diam.
	50	100	200	300	600	900		
NR2105	220	153	119	85	59	48	11	3/16
NR2106	356	247	170	137	96	78	10	1/4
NR2111-1	327	232	163	135	92	78	10	5/16
NR2111								
NR2112								
NR2113								
NR2118	500	344	240	192	134	109	14	1/4
NR2120	293	208	146	121	82	70	14	1/4

STANDARD TOLERANCES

DIMENSIONS	TOLERANCE
A	All
	+ .005 to -.000

Anti-Friction Bearings

2200 Series

Ball Bearings Wheels; Unground

The NR 2200 series pressed steel, ball bearing type wheels conform to the drawings showing their tread types. NR2201, 2204 and 2205 have ball races and outer housing carefully hardened. NR 2203 and 2206 have hardened races and unhardened outer housings.



ALL DIMENSIONS IN INCHES
ORDER BY CATALOG NUMBER OR ITEM CODE

A	B	C	D	E	R	Catalog No.	Item Code
1/4	1.400	1/2	7/16	9/16	—	NR2201	67159
3/8	2-1/8	1/2	5/8	13/16	—	NR2203	67160
3/8	2-1/2	11/16	11/16	1	—	NR2204	67161
17/32	2-1/2	11/16	11/16	1	—	NR2205	67162
1/2	2-3/4	9/16	11/16	1	3/4	NR2206	67163

STANDARD TOLERANCES

DIMENSIONS		TOLERANCE
A	All	+.005 to -.000

LOAD DATA*

Wheel Number	Radial Load Capacity in Pounds						Balls	
	Revolutions Per Minute						No.	Diam.
	50	100	200	300	600	900		
NR2201	91	66	47	37	25	23	15	1/8
NR2203	230	164	115	95	65	55	15	3/16
NR2204	136	100	71	56	38	34	14	1/4
NR2205								
NR2206	327	232	163	135	92	78	14	1/4

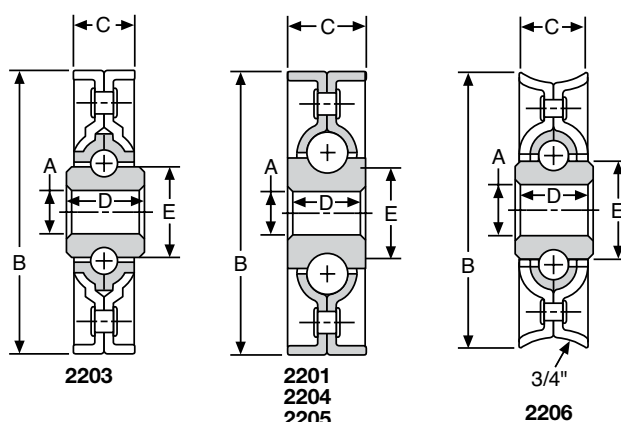

Flanged 2300 Series Unground

The NR 2300 Series pressed steel, ball bearing type wheels are advantageous for application to wooden rollers or steel tubes, pipes, etc. The flange serves as an economical method of locating the roller in its nest. The ball races are carefully hardened while the outer housing is unhardened.

ALL DIMENSIONS IN INCHES
ORDER BY CATALOG NUMBER OR ITEM CODE

A	B	C	D	E	F	G	H	I	J	K	L	M	N	O	P	Q	R	S	T	U	V	W	X	Y	Z
3/8	2	1/2	11/16	9/16	1.875	1.875	7/16	NR2308	67165																
3/8	2-1/4	9/16	3/4	9/16	1.625	1.625	1/2	NR2312+	67166																
1/2	3	9/16	15/16	1	2.781	2.810	1/2	NR2324	67167																

+Screw holes in Flange, for application to Wood Rollers.

STANDARD TOLERANCES

DIMENSIONS		TOLERANCE
A	All	+.005 to -.000

LOAD DATA*

Wheel Number	Radial Load Capacity in Pounds						Balls	
	Revolutions Per Minute						No.	Diam.
	50	100	200	300	600	900		
NR2308	77	56	40	32	21	19	15	1/8
NR2312	220	153	119	85	59	48	15	1/8
NR2324	327	232	163	135	92	78	14	1/4

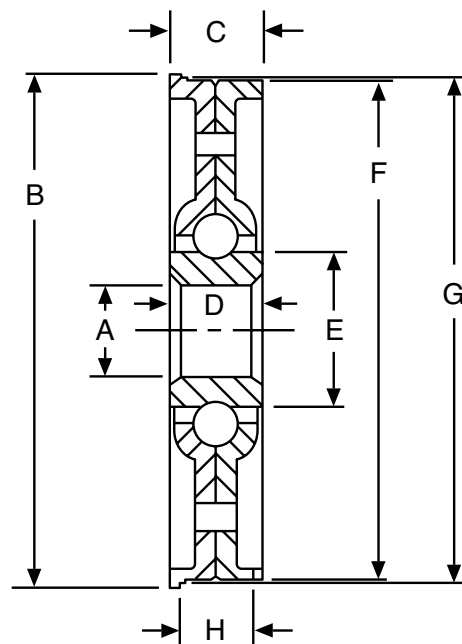

*Load ratings are provided only as a guide for bearing selection and are not to be used for life calculation.

Self-Aligning Bearings

KF Female Series Rod Ends – Economical

F

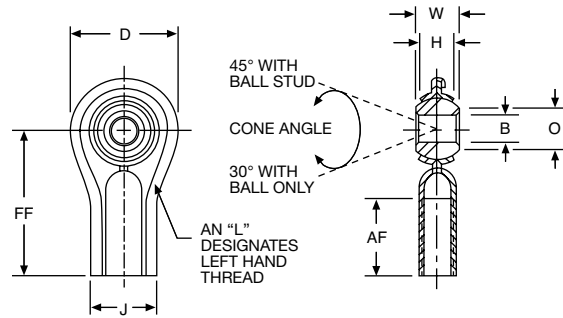
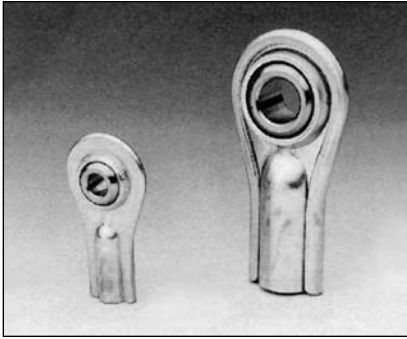

SPECIFICATIONS

Outer Member	Low carbon steel stamping plated for corrosion resistance
Ball	Low carbon steel, case hardened plated for corrosion resistance and wear

ALL DIMENSIONS IN INCHES

Bore B	W	H	AF	FF	D	J	O	Ball Dia.	Thread
+0.0025 -0.0005	±.005	REF	±.060	±.030	±.030	REF	REF	REF	Class UNF-2
.1900	.312	.250	.500	1.062	.750	.450	.296	.430	10-32
.2500	.375	.287	.687	1.312	.850	.515	.346	.510	1/4-28
.3125	.437	.305	.687	1.375	1.015	.590	.438	.618	5/16-24
.3750	.500	.400	.875	1.625	1.125	.725	.508	.713	3/8-24
.5000	.625	.500	1.125	2.125	1.470	1.010	.690	.931	1/2-20

LOAD DATA

Basic Bearing Number	Ultimate Static Load (Radial) Rating (Lbs.)	Approx. Wt. (Lbs.)
3	1,000	.02
4	1,900	.04
5	2,300	.07
6	3,000	.11
8	6,100	.23

ORDER BY CATALOG NUMBER OR ITEM CODE

Bore	Right Hand		Left Hand	
	Catalog Number	Item Code	Catalog Number	Item Code
.1900	KF-3	65001	KFL-3	65070
.2500	KF-4	65002	KFL-4	65140
.3125	KF-5	65041	KFL-5	65141
.3750	KF-6	65042	KFL-6	65142
.5000	KF-8	65069	KFL-8	65252

NOTES: To order with optional studs, add letters "Y" or "S" to suffix. For stud specifications, see Page 211. For Engineering Data, see Pages 207-211.

Self-Aligning Bearings

HM-C Male/HF-C Female Series Rod Ends – Commercial

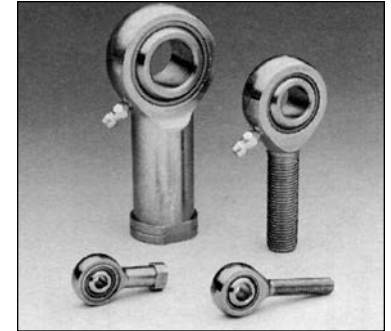
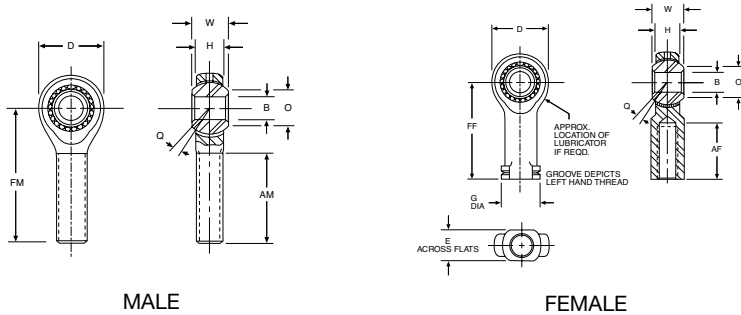

ALL DIMENSIONS IN INCHES

Bore B	W	H	AM	FM	AF	FF	D	G	E	O	Ball Dia.	Q	Thread
+ .0025 - .0005	±.005	REF	±.060	±.030	±.060	±.030	±.010	REF	REF	REF	REF	REF	Class UNF-2
.1900	.312	.250	.750	1.250	.562	1.062	.750	.406	.312	.296	.430	±5-1/2°	10-32
.2500	.375	.281	1.000	1.562	.750	1.312	.750 ¹	.468	.375	.346	.510	±6-1/2°	1/4-28
.3125	.437	.344	1.250	1.875	.750	1.375	.875	.500	.437	.438	.618	±5-1/2°	5/16-24
.3750	.500	.406	1.250	1.938	.937	1.625	1.000	.687	.562	.508	.713	±5°	3/8-24
.4375	.562	.437	1.375	2.125	1.062	1.812	1.125	.750	.625	.578	.806	±6°	7/16-20
.5000	.625	.500	1.500	2.438	1.187	2.125	1.312	.875	.750	.690	.931	±5°	1/2-20
.6250	.750	.562	1.625	2.625	1.500	2.500	1.500	1.000	.875	.801	1.098	±6°	5/8-18
.7500	.875	.687	1.750	2.875	1.750	2.875	1.750	1.125	1.000	1.010	1.336	±5°	3/4-16

+Tolerance +.015/- .010

ORDER BY CATALOG NUMBER OR ITEM CODE

Bore	Right Hand				Left Hand			
	With Lubricator		Without Lubricator		With Lubricator		Without Lubricator	
	Catalog Number	Item Code	Catalog Number	Item Code	Catalog Number	Item Code	Catalog Number	Item Code
MALE TYPE								
.1900	—	—	HM-3C	48193	—	—	HML-3C	48208
.2500	HM-4CG	48201	HM-4C	48194	HML-4CG	48216	HML-4C	48209
.3125	HM-5CG	48202	HM-5C	48195	HML-5CG	48217	HML-5C	48210
.3750	HM-6CG	48203	HM-6C	48196	HML-6CG	48218	HML-6C	48211
.4375	HM-7CG	48204	HM-7C	48197	HML-7CG	48219	HML-7C	48212
.5000	HM-8CG	48205	HM-8C	48198	HML-8CG	48220	HML-8C	48213
.6250	HM-10CG	48206	HM-10C	48199	HML-10CG	48221	HML-10C	48214
.7500	HM-12CG	48207	HM-12C	48200	HML-12CG	48222	HML-12C	48215
FEMALE TYPE								
.1900	—	—	HF-3C	48163	—	—	HFL-3C	48178
.2500	HF-4CG	48171	HF-4C	48164	HFL-4CG	48186	HFL-4C	48179
.3125	HF-5CG	48172	HF-5C	48165	HFL-5CG	48187	HFL-5C	48180
.3750	HF-6CG	48173	HF-6C	48166	HFL-6CG	48188	HFL-6C	48181
.4375	HF-7CG	48174	HF-7C	48167	HFL-7CG	48189	HFL-7C	48182
.5000	HF-8CG	48175	HF-8C	48168	HFL-8CG	48190	HFL-8C	48183
.6250	HF-10CG	48176	HF-10C	48169	HFL-10CG	48191	HFL-10C	48184
.7500	HF-12CG	48177	HF-12C	48170	HFL-12CG	48192	HFL-12C	48185

SPECIFICATIONS

Outer Member	Low carbon steel plated for corrosion resistance
Ball	Case hardened steel plated for corrosion resistance and wear
Insert	Oil impregnated sintered bronze

LOAD DATA

Basic Bearing Number	Ultimate Static Load (Radial) Rating (Lbs.)		Approx. Wt. (Lbs.)	
	Male	Female	Male	Female
3	1,600	1,800	.04	.04
4	2,250	2,300	.05	.06
5	2,850	2,900	.08	.09
6	3,900	4,300	.12	.16
7	5,300	5,350	.17	.20
8	7,400	8,400	.27	.32
10	9,350	9,550	.40	.48
12	10,450	10,500	.72	.72

NOTES:

To order with optional studs, add letter "Y" or "S" to suffix. For stud specifications, see Page 211.

Lubricators available on sizes 4 through 12 only, studs available on all sizes.

For Engineering Data, see Pages 207-211.

Self-Aligning Bearings

CMHD Male/CFHD Female Series Rod Ends – Commercial; Self Lubricating

F

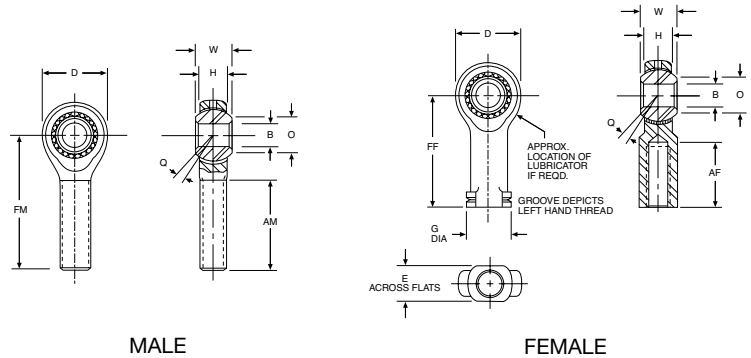
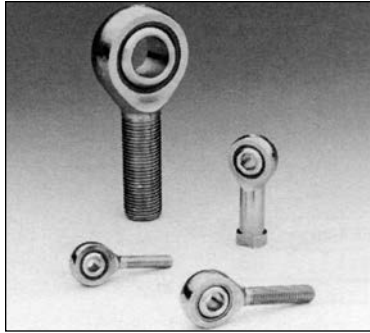

ALL DIMENSIONS IN INCHES

Bore B	W	H	AM	FM	AF	FF	D	G	E	O	Ball Dia.	Thread	Q
+0.0025 -0.0005	±.005	REF	±.060	±.030	±.060	±.030	±.010	REF	REF	REF	REF	Class UNF-2	REF
.1900	.312	.250	.750	1.250	.562	1.062	.625	.406	.312	.296	.430	10-32	±6°
.2500	.375	.281	1.000	1.562	.750	1.312	.750	.468	.375	.346	.510	1/4-28	±7°
.3125	.437	.344	1.250	1.875	.750	1.375	.875	.500	.437	.438	.618	5/16-24	±6°
.3750	.500	.406	1.250	1.938	.937	1.625	1.000	.687	.562	.508	.713	3/8-24	±5-1/2°
.4375	.562	.437	1.375	2.125	1.062	1.812	1.125	.750	.625	.578	.806	7/16-20	±6°
.5000	.625	.500	1.500	2.438	1.187	2.125	1.312	.875	.750	.690	.931	1/2-20	±5°
.6250	.750	.562	1.625	2.625	1.500	2.500	1.500	1.000	.875	.801	1.098	5/8-18	±7-1/2°
.7500	.875	.687	1.750	2.875	1.750	2.875	1.750	1.125	1.000	1.010	1.336	3/4-16	±6°

SPECIFICATIONS

Outer Member	Low carbon steel plated for corrosion resistance
Ball	Case hardened steel electroless nickel plated
Insert	Reinforced nylon

LOAD DATA

Basic Bearing Number	Ultimate Static Load (Radial) Rating (Lbs.)		Approx. Wt. (Lbs.)
	Male	Female	
3	1,150	1,200	.02
4	1,600	1,650	.04
5	2,700	2,800	.07
6	3,200	3,250	.11
7	3,750	3,800	.15
8	5,800	6,400	.23
10	7,050	7,100	.38
12	8,800	9,000	.58

ORDER BY CATALOG NUMBER OR ITEM CODE

Bore	Right Hand		Left Hand	
	Catalog Number	Item Code	Catalog Number	Item Code
MALE TYPE				
.1900	CMHD-3	48307	CMHDL-3	48315
.2500	CMHD-4	48308	CMHDL-4	48316
.3125	CMHD-5	48309	CMHDL-5	48317
.3750	CMHD-6	48310	CMHDL-6	48318
.4375	CMHD-7	48311	CMHDL-7	48319
.5000	CMHD-8	48312	CMHDL-8	48320
.6250	CMHD-10	48313	CMHDL-10	48321
.7500	CMHD-12	48314	CMHDL-12	48322
FEMALE TYPE				
.1900	CFHD-3	48291	CFHDL-3	48299
.2500	CFHD-4	48292	CFHDL-4	48300
.3125	CFHD-5	48293	CFHDL-5	48301
.3750	CFHD-6	48294	CFHDL-6	48302
.4375	CFHD-7	48295	CFHDL-7	48303
.5000	CFHD-8	48296	CFHDL-8	48304
.6250	CFHD-10	48297	CFHDL-10	48305
.7500	CFHD-12	48298	CFHDL-12	48306

NOTES:

To order with optional studs, add letter "Y" or "S" to suffix. For stud specifications, see Page 211.
For Engineering Data, see Pages 207-211.

Self-Aligning Bearings

HM Males/HF Female Series Rod Ends – Precision

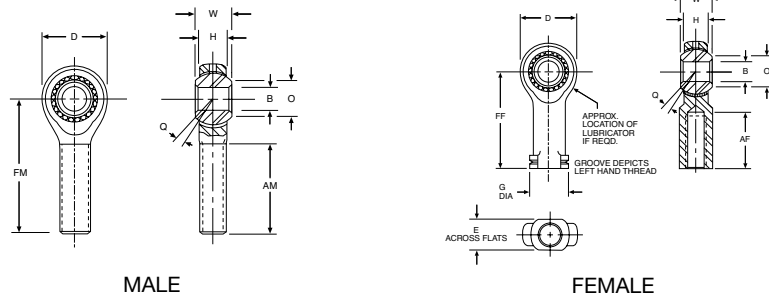

ALL DIMENSIONS IN INCHES

Bore B	W	H	AM	FM	AF	FF	D	G	E	O	Ball Dia.	Q	Thread
+0.0015 -0.0005	±.005	REF	±.060	±.030	±.060	±.030	±.010	REF	REF	REF	REF	REF	Class UNF-2
.1900	.312	.250	.750	1.250	.562	1.062	.750	.406	.312	.296	.430	±5-1/2°	10-32
.2500	.375	.281	1.000	1.562	.750	1.312	.750 ⁽¹⁾	.468	.375	.346	.510	±6-1/2°	1/4-28
.3125	.437	.344	1.250	1.875	.750	1.375	.875	.500	.437	.438	.618	±5-1/2°	5/16-24
.3750	.500	.406	1.250	1.938	.937	1.625	1.000	.687	.562	.508	.713	±5°	3/8-24
.4375	.562	.437	1.375	2.125	1.062	1.812	1.125	.750	.625	.578	.806	±6°	7/16-20
.5000	.625	.500	1.500	2.438	1.187	2.125	1.312	.875	.750	.690	.931	±5°	1/2-20
.6250	.750	.562	1.625	2.625	1.500	2.500	1.500	1.000	.875	.801	1.098	±6°	5/8-18
.7500	.875	.687	1.750	2.875	1.750	2.875	1.750	1.125	1.000	1.010	1.336	±5°	3/4-16
1.0000	1.375	1.000	2.125	4.125	2.125	4.125	2.750 ⁽²⁾	1.625	1.500	1.269	1.875	7°	1-1/4-12 ⁽⁴⁾

(1) Tolerance +.015/-0.10

(2) Tolerance +.030/-0.10

(3) Tolerance +.000/-0.005

(4) Class 3 Threads

ORDER BY CATALOG NUMBER OR ITEM CODE

Bore	Right Hand				Left Hand			
	With Lubricator		Without Lubricator		With Lubricator		Without Lubricator	
	Catalog Number	Item Code	Catalog Number	Item Code	Catalog Number	Item Code	Catalog Number	Item Code
MALE TYPE								
.1900	—	—	HM-3	48259	—	—	HML-3	48276
.2500	HM-4G	48267	HM-4	48260	HML-4G	48284	HML-4	48277
.3125	HM-5G	48268	HM-5	48261	HML-5G	48285	HML-5	48278
.3750	HM-6G	48269	HM-6	48262	HML-6G	48286	HML-6	48279
.4375	HM-7G	48270	HM-7	48263	HML-7G	48287	HML-7	48280
.5000	HM-8G	48271	HM-8	48264	HML-8G	48288	HML-8	48281
.6250	HM-10G	48272	HM-10	48265	HML-10G	48289	HML-10	48282
.7500	HM-12G	48273	HM-12	48266	HML-12G	48290	HML-12	48283
1.0000	HM-16G	48103	HM-16	48102	HML-16G	48107	HML-16	48106
FEMALE TYPE								
.1900	—	—	HF-3	48225	—	—	HFL-3	48242
.2500	HF-4G	48233	HF-4	48226	HFL-4G	48250	HFL-4	48243
.3125	HF-5G	48234	HF-5	48227	HFL-5G	48251	HFL-5	48244
.3750	HF-6G	48235	HF-6	48228	HFL-6G	48252	HFL-6	48245
.4375	HF-7G	48236	HF-7	48229	HFL-7G	48253	HFL-7	48246
.5000	HF-8G	48237	HF-8	48230	HFL-8G	48254	HFL-8	48247
.6250	HF-10G	48238	HF-10	48231	HFL-10G	48255	HFL-10	48248
.7500	HF-12G	48239	HF-12	48232	HFL-12G	48256	HFL-12	48249
1.0000	HF-16G	48105	HF-16	48104	HFL-16G	48109	HFL-16	48108

SPECIFICATIONS

	Sizes 3 - 12	Size 16
Outer Member	Low carbon steel plated for corrosion resistance	
Ball	Case hardened steel for corrosion resistance and wear	52100 steel heat treated plated for corrosion resistance
Insert	Oil impregnated sintered bronze	Low carbon steel plated for corrosion resistance

LOAD DATA

Basic Bearing Number	Ultimate Static Load (Radial) Rating (Lbs.)		Approx. Wt. (Lbs.)	
	Male	Female	Male	Female
3	1,600	1,800	.04	.04
4	2,250	2,300	.05	.06
5	2,850	2,900	.08	.09
6	3,900	4,300	.12	.16
7	5,300	5,350	.17	.20
8	7,400	8,400	.27	.32
10	9,350	9,550	.40	.48
12	10,450	10,500	.62	.72
16	43,540	43,540	2.41	2.13

NOTES:

To order with optional studs, add letter "Y" or "S" to suffix. For stud specifications, see Page 211.

Lubricators available on sizes 4 through 16 only, studs available on sizes 3 through 12 only.

For Engineering Data, see Pages 207-211.

Self-Aligning Bearings

HME Male/HFE Female Series Rod Ends – Precision; Self Lubricating

F

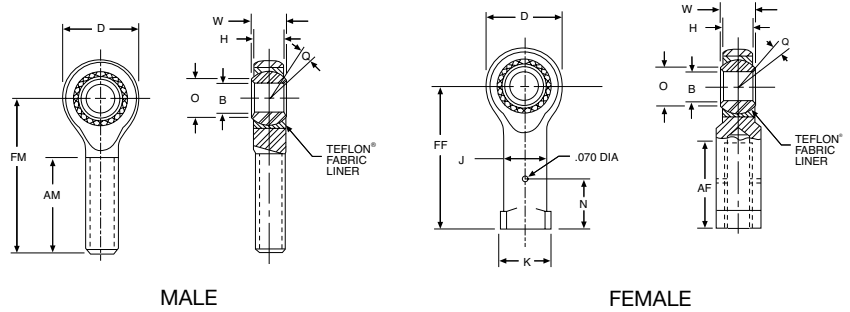

ALL DIMENSIONS IN INCHES

Bore B	W	H	AM	FM	AF	FF	D	O	J	K	N	Ball Dia.	Q	Thread
+ .0015 - .0005	+ .000 - .005	±.005	+ .060 - .030	±.010	+ .060 - .030	±.010	±.010	REF	±.010	±.010	+ .000 - .005	REF	REF	Class UNF-3
.1900	.312	.250	.750	1.250	.562	1.062	.625	.306	.312	.406	.312	.406	±6-1/2°	10-32
.2500	.375	.281	1.000	1.562	.750	1.312	.750	.331	.375	.468	.312	.500	±8°	1/4-28
.3125	.437	.344	1.250	1.875	.750	1.375	.875	.447	.437	.500	.406	.625	±7°	5/16-24
.3750	.500	.406	1.250	1.938	.937	1.625	1.000	.517	.562	.687	.469	.713	±6°	3/8-24
.4375	.562	.437	1.375	2.125	1.062	1.812	1.125	.586	.625	.750	.531	.813	±7°	7/16-20
.5000	.625	.500	1.500	2.438	1.187	2.125	1.312	.656	.750	.875	.594	.906	±6°	1/2-20
.6250	.750	.562	1.625	2.625	1.500	2.500	1.500	.832	.875	1.000	.750	1.125	±8°	5/8-18
.7500	.875	.687	1.750	2.875	1.750	2.875	1.750	.978	1.000	1.125	.875	1.312	±7°	3/4-16
1.0000	1.375	1.000 ⁽¹⁾	2.125	4.125	2.125	4.125	2.750 ⁽²⁾	1.269	1.500	1.625	—	1.875	±7°	1-1/4-12

(1) Tolerance +.015/- .010

(2) Tolerance +.030/- .010

SPECIFICATIONS

Outer Member	Low carbon steel plated for corrosion resistance
Ball	52100 Steel - heat treated Rc 56 Min hard chrome plated
Insert	Carbon steel - plated for corrosion resistance or stainless steel
Liner	Teflon® fabric permanently bonded to insert I.D.

Teflon® is a trade name of E.I. DuPont de Nemours & Co. Inc.

LOAD DATA

Basic Bearing Number	Ultimate Static Load (Radial) Rating (Lbs.)		Approx. Wt. (Lbs.)	
	Male	Female	Male	Female
3	1,169	1,531	.03	.04
4	2,158	2,539	.04	.06
5	2,784	3,133	.08	.09
6	3,915	3,915	.12	.16
7	4,218	4,218	.16	.20
8	6,660	6,660	.25	.32
10	7,364	7,364	.39	.48
12	11,518	11,518	.60	.72
16	43,540	43,540	2.41	2.13

NOTE:

For Engineering Data, see Pages 207-211.

ORDER BY CATALOG NUMBER OR ITEM CODE

Bore	Right Hand		Left Hand	
	Catalog Number	Item Code	Catalog Number	Item Code
MALE TYPE				
.1900	HME-3	48038	HMLE-3	48059
.2500	HME-4	48039	—	—
.3125	HME-5	48040	HMLE-5	48065
.3750	HME-6	48041	HMLE-6	48067
.4375	HME-7	48043	HMLE-7	48068
.5000	HME-8	48044	HMLE-8	48069
.6250	HME-10	48045	HMLE-10	48076
.7500	HME-12	48046	HMLE-12	48077
1.0000	HME-16	48047	HMLE-16	48078
FEMALE TYPE				
.1900	HFE-3	48079	HFLE-3	48004
.2500	HFE-4	48080	HFLE-4	48006
.3125	HFE-5	48086	HFLE-5	48007
.3750	HFE-6	48088	HFLE-6	48008
.4375	HFE-7	48091	HFLE-7	48010
.5000	HFE-8	48093	HFLE-8	48012
.6250	HFE-10	48094	HFLE-10	48014
.7500	HFE-12	48095	HFLE-12	46017
1.000	HFE-16	48096	HFLE-16	48019

Self-Aligning Bearings

HMX Male/HFX Female Series Rod Ends – Extra Capacity

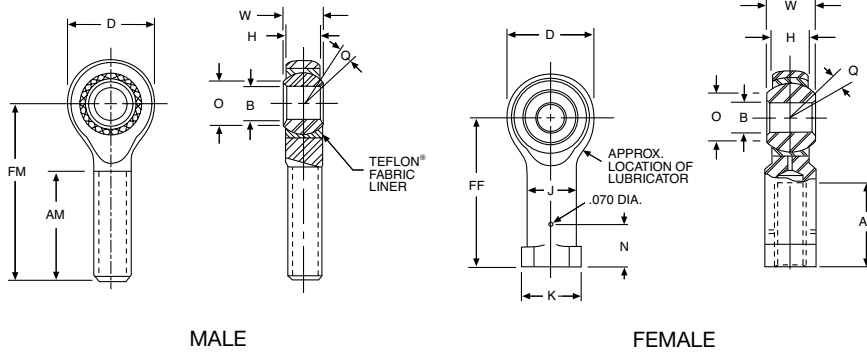

ALL DIMENSIONS IN INCHES

Bore B	W	H	AM	FM	AF	FF	D	O	J	K	N	Ball Dia.	Q	Female Thread	Male Thread
+0.0015 -0.0005	+0.000 -0.005	±0.005	+0.060 -0.030	±0.010	+0.060 -0.030	±0.010	±0.010	REF	±0.010	±0.010	+0.000 -0.005	REF	REF	Class UNF-3B	Class UNF-3A
.2500	.375	.281	1.000	1.562	.750	1.312	.750	.331	.375	.468	.312	.500	±8°	1/4-28	5/16-24
.3125	.437	.344	1.250	1.875	.750	1.375	.875	.447	.437	.500	.406	.625	±7°	5/16-24	3/8-24
.3750	.500	.406	1.250	1.938	.937	1.625	1.000	.517	.562	.687	.469	.718	±6°	3/8-24	7/16-20
.4375	.562	.437	1.375	2.125	1.062	1.812	1.125	.586	.625	.750	.531	.813	±7°	7/16-20	1/2-20
.5000	.625	.500	1.500	2.438	1.187	2.125	1.312	.656	.750	.875	.594	.906	±6°	1/2-20	5/8-18
.6250	.750	.562	1.625	2.625	1.500	2.500	1.500	.832	.875	1.000	.750	1.125	±8°	5/8-18	3/4-16
.7500	.875	.687	1.750	2.875	1.750	2.875	1.750	.978	1.000	1.125	.875	1.312	±7°	3/4-16	7/8-14
.7500	.875	.687	1.750	2.875	1.750	2.875	1.750	.978	1.000	1.125	.875	1.312	±7°	3/4-16	7/8-14

ORDER BY CATALOG NUMBER OR ITEM CODE

Bore	Right Hand with Lubricator		Left Hand with Lubricator	
	Catalog Number	Item Code	Catalog Number	Item Code
MALE TYPE				
.2500	HMX-4G	48337	HMXL-4G	48344
.3125	HMX-5G	48338	HMXL-5G	48345
.3750	HMX-6G	48339	HMXL-6G	48346
.4375	HMX-7G	48340	HMXL-7G	48347
.5000	HMX-8G	48341	HMXL-8G	48348
.6250	HMX-10G	48342		
.7500	HMX-12G	48343	HMXL-12G	48350
FEMALE TYPE				
.2500	HFX-4G	48323	HFXL-4G	48330
.3125	HFX-5G	48324	HFXL-5G	48331
.3750	HFX-6G	48325	HFXL-6G	48332
.4375	HFX-7G	48326	HFXL-7G	48333
.5000	HFX-8G	48327	HFXL-8G	48334
.6250	HFX-10G	48328	HFXL-10G	48335
.7500	HFX-12G	48329	HFXL-12G	46336

NOTE

For Engineering Data, see Pages 207-211.

SPECIFICATIONS

	HMX Series	HFX Series
Outer Member	Alloy steel, heat treated magnetic particle inserted plated for corrosion resistance	Steel alloy, heat treated plated for corrosion resistance
Ball	52100 steel heat treated, hard chrome plated	52100 steel heat treated, hard chrome plated
Insert	Aluminum bronze	Alloy steel, heat treated plated for corrosion resistance or stainless steel, heat treated

LOAD DATA

Basic Bearing Number	Ultimate Static Load (Radial) (Lbs.)		Approx. Wt. (Lbs.)	
	Male	Female	Male	Female
4	5,390	6,190	.06	.06
5	7,500	7,639	.09	.09
6	9,590	9,544	.13	.15
7	11,000	10,285	.18	.20
8	13,575	16,238	.30	.32
10	17,300	17,955	.46	.48
12	23,225	28,081	.72	.72

Self-Aligning Bearings

LHA-LHB-LHSS Series

Sphericals – Precision

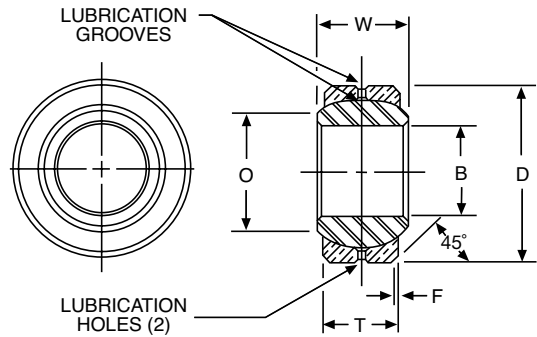

SPECIFICATIONS

	LHA	LHB	LHSS
Outer Member	4130 Steel or equal heat treated plated for corrosion resistance	Aluminum Bronze	410 or equal Stainless Steel
Ball	52100 Steel heat treated, plated for corrosion resistance and wear		

ORDER BY CATALOG NUMBER OR ITEM CODE ALL DIMENSIONS IN INCHES

Bore B	D	F	T	W	O	Ball Dia.	LHA Series		LHB Series		LHSS Series	
							Catalog Number	Item Code	Catalog Number	Item Code	Catalog Number	Item Code
+.0000 -.0005	+.0000 -.0005	REF	±.005	±.005	REF	REF						
.1650	.4687	.020	.187	.250	.235	.343	LHA-2	48405	LHB-2	48417	LHSS-2	48429
.1900	.5625	.020	.218	.281	.293	.406	LHA-3	48406	LHB-3	48418	LHSS-3	48430
.2500	.6562	.022	.250	.343	.364	.500	LHA-4	48407	LHB-4	48419	LHSS-4	48431
.3125	.7500	.032	.281	.375	.419	.562	LHA-5	48408	LHB-5	48420	LHSS-5	48432
.3750	.8125	.032	.312	.406	.517	.656	LHA-6	48409	LHB-6	48421	LHSS-6	48433
.4375	.9062	.032	.343	.437	.572	.718	LHA-7	48410	LHB-7	48422	LHSS-7	48434
.5000	1.0000	.032	.390	.500	.642	.813	LHA-8	48411	LHB-8	48423	LHSS-8	48435
.5625	1.0937	.032	.437	.562	.670	.906	LHA-9	48412	LHB-9	48424	LHSS-9	48436
.6250	1.1875	.032	.500	.625	.739	.968	LHA-10	48413	LHB-10	48425	LHSS-10	48437
.7500	1.4375	.044	.593	.750	.920	1.187	LHA-12	48414	LHB-12	48426	LHSS-12	48438
.8750	1.5625	.044	.703	.875	.980	1.312	LHA-14	48415	LHB-14	48427	LHSS-14	48439
1.0000	1.7500	.044	.797	1.000	1.118	1.500	LHA-16	48416	LHB-16	48428	LHSS-16	48440

LOAD DATA

Basic Bearing Number	Maximum Static Radial Load (Lbs.)		Approx. Weight (Lbs.)
	LHA/LHSS	LHB	
2	2,000	1,000	.01
3	5,400	2,700	.02
4	8,400	4,200	.02
5	11,600	5,800	.03
6	15,600	7,800	.04
7	18,600	9,300	.05
8	22,400	11,200	.07
9	30,000	15,000	.09
10	40,000	20,000	.11
12	50,000	30,000	.21
14	86,000	43,000	.27
16	104,000	52,000	.39

NOTES:

For Engineering Data, see Pages 207-211.
For Housing Bores, see Page 210.

Self-Aligning Bearings

LHSSE-LHSSV Series Sphericals – Precision; Self Lubricating

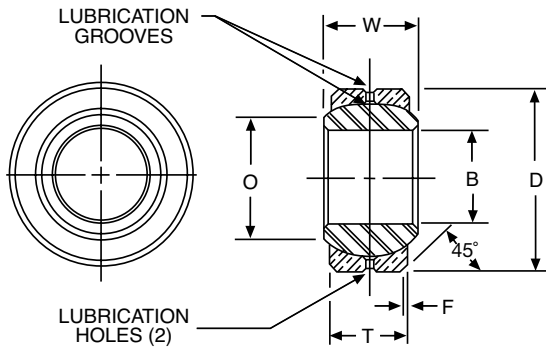

ORDER BY CATALOG NUMBER OR ITEM CODE ALL DIMENSIONS IN INCHES

Bore B	O	D	F	T	W	Ball Dia.	LHSSE Series		LHSSV Series	
							Catalog Number	Item Code	Catalog Number	Item Code
+.0000 -.0005	REF	+.0000 -.0005	REF	±.005	+.000 -.005	REF				
.1650	.235	.4687	.020	.187	.250	.343	LHSSE-2	48021	LHSSV-2	48453
.1900	.293	.5625	.020	.218	.281	.406	LHSSE-3	48023	LHSSV-3	48454
.2500	.364	.6562	.022	.250	.343	.500	LHSSE-4	48025	LHSSV-4	48455
.3125	.419	.7500	.032	.281	.375	.562	LHSSE-5	48027	LHSSV-5	48456
.3750	.517	.8125	.032	.312	.406	.656	LHSSE-6	48029	LHSSV-6	48457
.4375	.572	.9062	.032	.343	.437	.718	LHSSE-7	48030	LHSSV-7	48458
.5000	.642	1.0000	.032	.390	.500	.813	LHSSE-8	48032	LHSSV-8	48459
.5625	.670	1.0937	.032	.437	.562	.906	LHSSE-9	48033	LHSSV-9	48460
.6250	.739	1.1875	.032	.500	.625	.968	LHSSE-10	48034	LHSSV-10	48461
.7500	.920	1.4375	.044	.593	.750	1.187	LHSSE-12	48035	LHSSV-12	48462
.8750	.980	1.5625	.044	.703	.875	1.312	LHSSE-14	48036	LHSSV-14	48463
1.0000	1.118	1.7500	.044	.797	1.000	1.500	LHSSE-16	48037	LHSSV-16	48464

LOAD DATA

Basic Bearing Number	Maximum Static Radial Load (Lbs.)		Approx. Wt. (Lbs.)
	LHSSE	LHSSV	
2	1,200	1,200	.010
3	3,250	3,250	.014
4	4,900	4,900	.022
5	6,450	6,450	.03
6	8,250	8,250	.04
7	10,200	10,200	.05
8	13,600	13,600	.07
9	15,900	15,900	.09
10	21,000	21,000	.11
12	30,000	30,000	.21
14	41,100	41,100	.26
16	54,700	54,700	.39

SPECIFICATIONS

	LHSSE Series	LHSSV Series
Outer Member	410 Stainless Steel	410 Stainless Steel
Ball	52100 Steel heat treated plated for corrosion resistance and wear	52100 Steel heat treated plated for corrosion resistance and wear
Self Lubricating Liner	Teflon®	Teflon® Fabric

Teflon® is a trade name of E. I. DuPont de Nemours & Co. Inc.

NOTES:

For Engineering Data, see Pages 207-211.

Self-Aligning Bearings

LS/LSS Series

Sphericals – Special Purpose

F

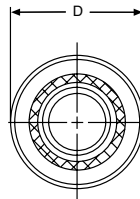

LS/LSS 3 – 10

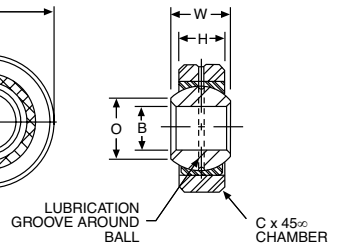
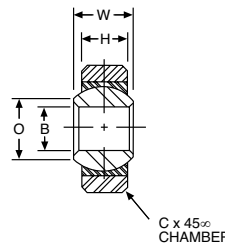

LS 12 – 30

ORDER BY CATALOG NUMBER OR ITEM CODE ALL DIMENSIONS IN INCHES

Bore B	D	H	w	Ball Dia.	O	C	LS Series	
+0.0025 -0.0005	+0.0000 -0.0005	±.005	±.005	REF	REF	+0.015 -0.000	Catalog Number	Item Code
.1900	.6250	.187	.281	.400	.285	.016	LS-3	48381
.2500	.7500	.281	.375	.510	.346	.016	LS-4	48382
.3125	.8750	.313	.437	.618	.438	.016	LS-5	48383
.3750	1.0000	.375	.500	.713	.508	.016	LS-6	48384
.4375	1.1875	.437	.562	.806	.578	.032	LS-7	48385
.5000	1.3125	.531	.687	.931	.627	.044	LS-8	48386
.6250	1.5625	.687	.875	1.178	.789	.044	LS-10	48387
.7500	2.2500	.937	1.250	1.625	1.038	.044	LS-12	48388
1.0000	2.3750	.875	1.125	1.750	1.345	.062	LS-16	48389
1.1875	2.6250	1.000	1.250	2.000	1.562	.085	LS-19	48390
1.5000	3.2500	1.250	1.500	2.500	2.000	.085	LS-24	48391
1.8750	4.0000	1.313	1.625	3.000	2.521	.125	LS-30	48392

SPECIFICATIONS

	LS Series		LSS Series
	Size 3 - 10	Size 12 - 30	All
Outer Member	Low carbon steel, plated for corrosion resistance	Carbon steel, cadmium or zinc plated	4130 Steel or equal, RC 36-42 cadmium plated
Ball	Low carbon steel, case hardened, plated for corrosion	Chrome steel heat treated	S.A.E. 52100 Steel heat treated and chrome plated
Insert	Sintered Bronze Oil impregnated	Brass	None

LOAD DATA

Bore B	D	H	w	Ball Dia.	O	C	LSS Series	
+0.0000 -0.0005	+0.0000 -0.0005	±.005 -.005	±.000 -.000	(REF)	(REF)	+0.000 -0.005	Catalog Number	Item Code
.1900	.5625	.218	.281	.406	.293	.020	LSS-3	48394
.2500	.6562	.250	.343	.500	.364	.022	LSS-4	48395
.3125	.7500	.281	.375	.562	.419	.032	LSS-5	48396
.3750	.8125	.312	.406	.656	.517	.032	LSS-6	48397
.4375	.9062	.343	.437	.718	.572	.032	LSS-7	48398
.5000	1.0000	.390	.500	.813	.642	.032	LSS-8	48399
.5625	1.0937	.437	.562	.906	.670	.032	LSS-9	48400
.6250	1.1875	.500	.625	.968	.739	.032	LSS-10	48401
.7500	1.4375	.593	.750	1.187	.920	.044	LSS-12	48402
.8750	1.5625	.703	.875	1.312	.980	.044	LSS-14	48403
1.0000	1.7500	.797	1.000	1.500	1.118	.044	LSS-16	48404

Basic Bearing Number	LS SERIES		LSS SERIES	
	Maximum Static Radial Load in Lbs.	Approx. Wt.(Lbs.)	Maximum Static Radial Load in Lbs.	Approx. Wt.(Lbs.)
3	1,520	.02	5,400	.014
4	2,900	.04	8,400	.022
5	3,900	.05	11,600	.030
6	5,400	.08	15,600	.038
7	7,100	.12	18,600	.048
8	9,900	.18	22,400	.065
9			30,000	.086
10	16,300	.33	40,000	.110
12	47,600	.94	50,000	.204
14			86,000	.263
16	48,200	1.00	104,000	.386
19	63,000	1.27		
24	98,000	2.38		
30	123,000	3.75		

NOTES:

For Engineering Data, see Pages 207-211.



Environment and Mounting

Corrosive Environments

All components are protected by plating or corrosion inhibiting oil.

Lubrication and Contaminants

The rating of all series with metal-on-metal bearing members is based on the presence of an adequate lubricant film. Ratings for the Reinforced Nylon race series are based on dry operation with the inherent lubrication provided by the bronze ball.

A controlled internal clearance is present in all metal-on-metal bearings. The reinforced Nylon race series are molded with a positive interference fit-up which excludes contaminants and results in an excellent self-wiping action.

Protection from contaminants should be provided wherever possible. Grease fittings or lubricant entry provisions are available for most metal-on-metal bearings. Periodic relubrication will improve operation under severe conditions. Contaminants are also flushed out during relubrication. Where relubrication is difficult or impractical, the self-lubricating features of the sintered ball or race materials and the reinforced Nylon race provide built-in protection.

Caution:

The lubricator mounting hole in housings reduces the strength of housings by varying amounts depending on size and location.

Mounting

Sintered bronze balls may be distorted by excessive clamping pressure. Care should be used in tightening a nut against the ball to prevent distortion or binding. Caution: certain ANSI bolt series with fillets under the head will interfere with proper assembly. Use of a countersunk washer is suggested.

Temperature and Water Immersion

Self Aligning bearings may be operated between -30°F and $+300^{\circ}\text{F}$, with wider ranges obtained by the use of special lubricants. Reinforced nylon race bearings may be operated between -30°F and $+150^{\circ}\text{F}$. Prolonged immersion of Nylon races in water can cause an increase in torque.

Engineering Data

Mounting and Misalignment Factors

The single biggest reason rod end bearings are used is for their ability to absorb gross misalignment and still transmit motion in the preferred direction. To overcome misalignment, the ball or housing rotates as far as necessary or until it strikes an obstruction. The amount of misalignment a bearing can absorb is limited by the mounting arrangement. Shown below are common mounting arrangements, along with an indication of the misalignment absorbing capabilities of each. The table lists the maximum angular displacement in each mounting mode.

Rod Ends offer the least misalignment absorbing capability when fitted closely between the legs of a clevis or when the ball is bolted against the face of a lever. The limit is reached when the housing head strikes the mounting member.

Adding a standoff washer with the same diameter as the ball face increases misalignment absorbing capability. The limit is reached when the washer strikes the face.

The greatest misalignment compensation results when the ball is fitted with a stud, the shank diameter of which equals the ball bore *chamfer*, (see A). One piece ball studs (see B) of similar proportions also allow similar misalignment. Exceeding these dimensional limits may deform the race, so care should be taken to choose the proper mounting arrangement.

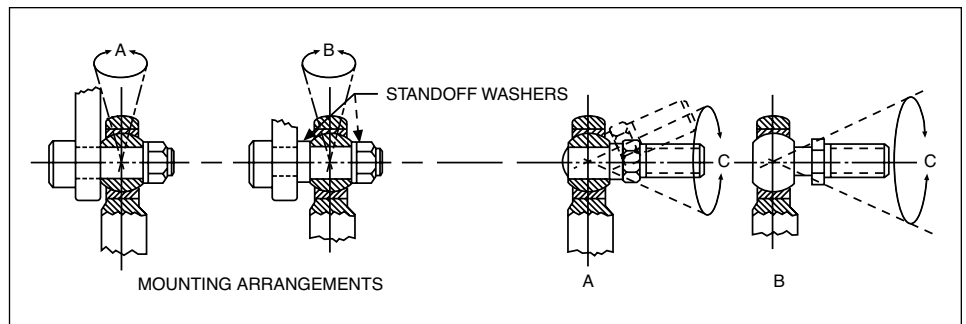
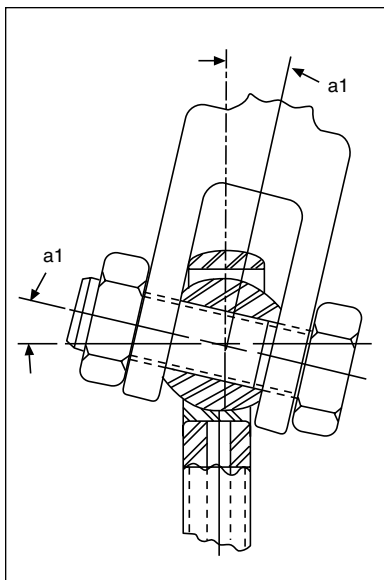

Reference Letters

- D – Head Diameter or Outer Race Diameter
- H – Housing Width
- W – Ball Width
- $A_1 = \sin^{-1} \frac{W}{D} - \sin^{-1} \frac{H}{D}$

ANGLE OF MISALIGNMENT (A1)

Size	SERIES			
	KF	HM-C/HF-C HM/HF	CMHD/CFHD	HME/HFE HMX/HFX
-3	±15°	±5-1/2°	±6°	±6-1/2°
-4	±15°	±6-1/2°	±7°	±8°
-5	±15°	±5-1/2°	±6°	±7°
-6	±15°	±5°	±5-1/2°	±6°
-7	—	±6°	±6°	±7°
-8	±15°	±5°	±5°	±6°
-10	—	±6°	±7-1/2°	±8°
-12	—	±5°	±6°	±7°
-16	—	±7°	—	±7°

Spherical bearings offer a greater variety of mounting positions compared to the rod end bearings. The angle of misalignment is calculated based on its mounting arrangement. Shown are three common mountings and the formulae for calculating the angle of misalignment.

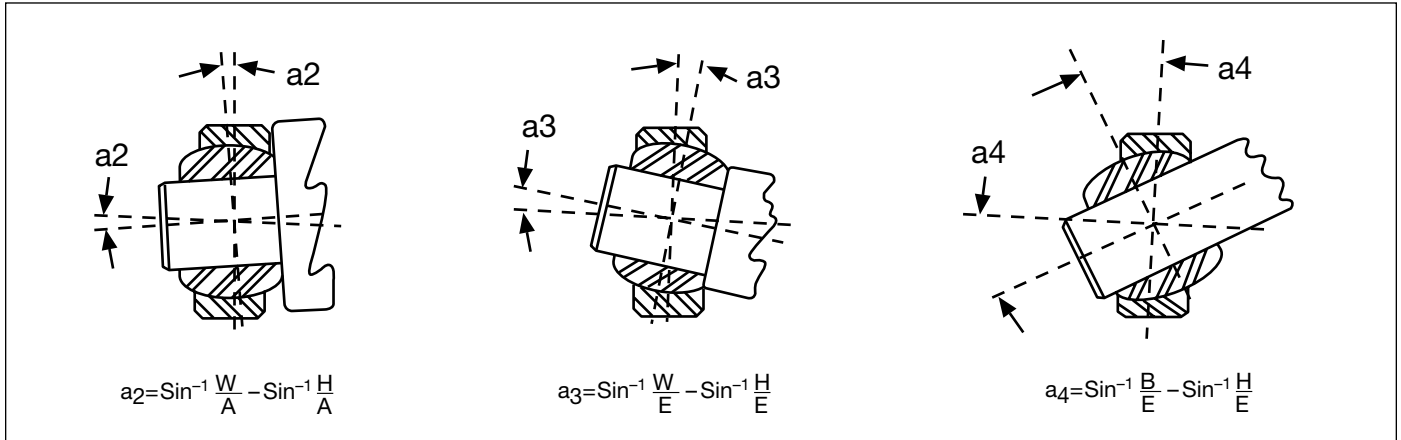

Reference Letters

- B – Ball Bore
- C – Outer Race Chamfer
- D – Head Diameter or Outer Race Diameter
- E – Ball Diameter
- H – Housing Width
- A – $\sqrt{(D-2C)^2 + H^2}$
- W – Ball Width

SPHERICAL BEARINGS

Series LS	Mounting Arrangements			Series LHA LHB LHSS LHSSE LHSSV	Mounting Arrangements		
	a ₂	a ₃	a ₄		a ₂	a ₃	a ₄
-3	±9°	±16 1/2°	±34 1/2°	-2	±8 1/2°	±13 1/2°	±28°
-4	±8°	±14 1/2°	±29°	-3	±7°	±11°	±29 1/2°
-5	±9°	±14°	±30°	-4	±9°	±13°	±30°
-6	±8°	±12 1/2°	±27°	-5	±8°	±12°	±26°
-7	±6 1/2°	±11°	±25°	-6	±7 1/2°	±10 1/2°	±23°
-8	±7 1/2°	±12 1/2°	±23°	-7	±6 1/2°	±9 1/2°	±20 1/2°
-10	±8°	±12°	±23°	-8	±7°	±10°	±20°
-12	±9°	±15°	±27°	-9	±7 1/2°	±10°	±20°
-16	±6 1/2°	±10°	±25°	-10	±7°	±9°	±19°
-19	±6°	±18 1/2°	±23 1/2°	-12	±7°	±9°	±21°
-24	±5°	±7°	±23°	-14	±7°	±9°	±16°
-30	±5°	±7°	±25°	-16	±7 1/2°	±9 1/2°	±16°

Engineering Information

Engineering Data

Housing Bore for Press Fit of Spherical Bearings

Basic Bearing Size	D Bearing O.D. +.0000 /-.0005	HOUSING BORE RECOMMENDED (Aluminum or Steel)
LS SERIES		
3	.6250	.6248/.6243
4	.7500	.7498/.7493
5	.8750	.8748/.8743
6	1.0000	.9998/.9993
7	1.1875	1.1873/1.1868
8	1.3125	1.3123/1.3118
10	1.5625	1.5623/1.5618
12	2.2500	2.2498/2.2493
16	2.3750	2.3748/2.3743
19	2.6250	2.6248/2.6243
24	3.2500	3.2498/3.2493
30	4.0000	3.9998/3.9993

Basic Bearing Size	D Bearing O.D. +.0000 /-.0005	HOUSING BORE RECOMMENDED (Aluminum or Steel)
LHA, LHB, LHSSE, LHSSV SERIES		
2	.4687	.4685/.4680
3	.5625	.5623/.5618
4	.6562	.6560/.6555
5	.7500	.7498/.7493
6	.8125	.8123/.8118
7	.9062	.9060/.9055
8	1.0000	.9998/.9993
9	1.0937	1.0935/1.0930
10	1.1875	1.1873/1.1868
12	1.4375	1.4373/1.4368
14	1.5625	1.5623/1.5618
16	1.7500	1.7498/1.7493

F

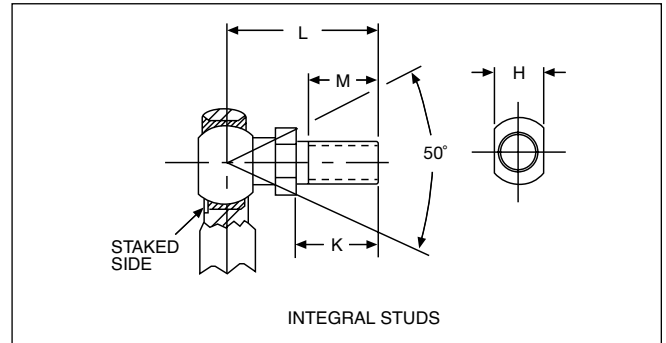
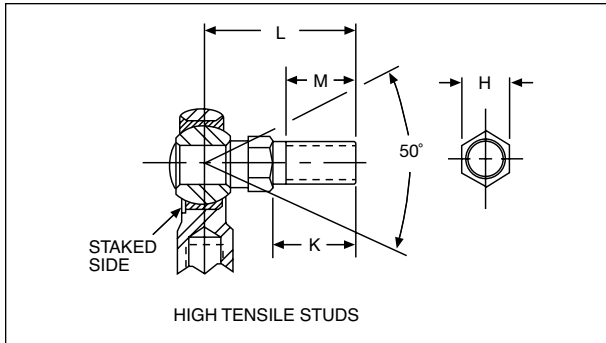

Steel studs are available in the CMHD/CFHD, HM/HF, HM-C/HF-C and KF Series to facilitate right angle connections. Standard misalignment is 50° in all sizes. Threads are only available as right hand. There are two types of studs available:

High Tensile Steel Studs–(Y Suffix)

High tensile steel studs are available for sizes 3 through 12. These studs are machined for exact fit-up within the ball bore, providing smooth operation and high performance. The studs are assembled to maintain the internal clearances inherent in the Rod Ends. They are permanently secured in the bore of the ball, threaded for easy mounting and have a hex section to facilitate tightening. The stud is designed to accommodate 50° misalignment in any direction, and provides maximum load capacity.

Integral Ball Studs–(S Suffix)

The ball and stud are combined into a single unit of case hardened machined plated steel. Wrench flats are provided for tightening. These studs offer the same operational features as the high tensile studs, with slightly reduced load capacity. The integral studs are available in sizes 3 through 8 only.

Numbering System

High Tensile Steel Studs

Use a “Y” suffix after the complete catalog number

Example: CFHDL-3Y

Integral Ball Stud

Use a “S” suffix after the complete catalog number

Example: HF-5S

Materials

Rod End: Refer to basic Rod End specification page

Stud: High tensile steel - Plated for corrosion resistance

Integral Stud: Low carbon steel - case hardened - plated for corrosion resistance

DIMENSIONS AND LOAD DATA

DIMENSIONS IN INCHES

To Fit Rod End Size	Stud Thread UNF-2	H	K	L	M	Static Load Rating (Lbs.)	
		±.005	±.010	±.015	MIN	High-Tensile Stud	Ball Stud
3	10-32	.312	.500	1.016	.437	350	250
4	1/4-28	.375	.562	1.047	.500	850	550
5	5/16-24	.438	.687	1.234	.594	1,600	1,050
6	3/8-24	.500	.906	1.570	.812	2,400	1,500
7	7/16-20	.625	1.125	1.968	.938	2,700	1,800
8	1/2-20	.625	1.125	2.000	.938	3,100	2,200
10	5/8-18	.750	1.500	2.500	1.250	4,500	N/A
12	3/4-16	1.000	1.812	3.000	1.625	6,000	N/A

Mounted Bearings

Replacement Bearings for Setscrew Locking Series

F



Mounted Bearings offer a simple, convenient method of providing load support. Selection for most applications may be readily accomplished from a single selection chart, based on shaft size, radial and thrust load requirements. Installation normally requires only bolting to a suitable mounting surface and securing bearing to shaft with setscrews or eccentric locking collar provided.

The Boston Gear Mounted Bearing line is one of the most comprehensive available to industry. Ranging from light duty, plain bearing blocks to precision units. They all feature Boston Gear's tradition of design excellence and precision manufacture.

Light Duty Series

PPB — Split cast iron housing with bore and mounting base machined.

SRP — PPB Series with a Bost-Bronz (oil impregnated) sleeve bearing.

PS — Stamped steel housing with pillow block, 2 bolt and 3 bolt flange configuration. Extended inner race, (2) setscrews locking to shaft. Prelubricated spherical O.D. bearing.

XL — Ductile iron housing with pillow block, 2 bolt and 3 bolt flange configuration. Extended inner race, (2) setscrews locking to shaft. Prelubricated spherical O.D. bearing.

Standard Duty Series

All Series — Solid one-piece cast iron housing of American manufacture with removable zerk-type threaded grease fitting. Precision machined base and spherical bore. Available in pillow block, 2 bolt and 4 bolt flanges.

H & L Series — Eccentric shaft lock of international manufacture.

S Series — Extended inner race with double setscrews for positive shaft locking.

Medium Duty Series

MB Series — Solid one-piece heavy duty cast iron housing with removable zerk-type threaded grease fitting. Available in pillow block 4 bolt flange and piloted flange with precision machined base, pilot diameter and spherical bore. Spherical O.D. bearing of international manufacture with extended inner race and double setscrews for positive shaft locking and smoothness of operation.

Mounted Bearings

Replacement Bearings and Locking Collars for Eccentric Locking Collar Series



F

ORDER BY CATALOG NUMBER OR ITEM CODE

Bore	INTERNATIONAL BEARINGS					
	Replacement Bearings		Locking Collars		Bearing and Carrier (A Series Only)	
	Catalog Number	Item Code	Catalog Number	Item Code	Catalog Number	Item Code
1/2	NX3008M	67374	NX3008LC	67373	3A-1/2 B&C	07030
5/8	NX3010M	67377	—	—	3A-5/8 B&C	07032
3/4	NX4012M	67380	NX4012LC	67379	4A-3/4 B&C	07014
7/8	NX5014M	67383	—	—	5A-7/8 B&C	07034
15/16	NX5015M	67386	NX5015LC	67385	5A-15/16 B&C	07036
1	NX5016M	67389	NX5016LC	67388	5A-1 B&C	07022
1-1/8	NX6018M	67392	—	—	6A-1-1/8 B&C	07038
1-3/16	NX6019M	67395	NX6019LC	67394	6A-1-3/16 B&C	07040
1-1/4S	NX6020M	67398	NX6020LC	67397	6A-1-1/4 B&C	07042
1-1/4	NX7104M	67401	—	—	—	—
1-5/16	NX7105M	67404	NX7105LC	67403	—	—
1-3/8	NX7106M	67407	NX7106LC	67406	—	—
1-7/16	NX7107M	67410	NX7107LC	67409	—	—
1-1/2	NX8108M	67413	NX8108LC	67412	—	—
1-5/8	NX9110M	67416	NX9110LC	67415	—	—
1-11/16	NX9111M	67419	NX9111LC	67418	—	—
1-3/4	NX9112M	67422	NX9112LC	67421	—	—
1-15/16	NX10115M	67425	NX10115LC	67424	—	—
2	NX11200M	67428	NX11200LC	67427	—	—
2-3/16	NX11203M	67431	NX11203LC	67430	—	—
2-1/4	NX11204M	67434	—	—	—	—
2-7/16	NX11207M	67437	NX11207LC	67436	—	—

(FOR USE WITH THE L, H, F, T AND A SERIES BEARINGS)

Mounted Bearings

Replacement Bearings for Setscrew Locking Series

F



PS & XL SERIES

Bore	Catalog Number	Item Code
1/2	NBG15-1/2	68880
5/8	NBG15-5/8	68881
3/4	NBG15-3/4	68882
7/8	NBG15-7/8	68883
15/16	NBG15-15/16	68884
1	NBG15-1	68885
1-1/16	NBG15-1-1/16	68886
1-1/8	NBG15-1-1/8	68887
1-3/16	NBG15-1-3/16	68888
1-1/4S	NBG15-1-1/4S	68889
1-3/8	NBG15-1-3/8	68891
1-7/16	NBG15-1-7/16	68892

(FOR USE WITH THE PS, PS2, PS3, XL, XL2 AND XL3 SERIES BEARINGS)

S SERIES

Bore	Catalog Number	Item Code
1/2	NBG25-1/2	68893
5/8	NBG25-5/8	68894
3/4	NBG25-3/4	68895
7/8	NBG25-7/8	68896
15/16	NBG25-15/16	68897
1	NBG25-1	68898
1-1/16	NBG25-1-1/16	68899
1-1/8	NBG25-1-1/8	68900
1-3/16	NBG25-1-3/16	68901
1-1/4S	NBG25-1-1/4S	68902
1-5/16	NBG25-1-5/16	68903
1-3/8	NBG25-1-3/8	68904
1-7/16	NBG25-1-7/16	68905
1-1/2	NBG25-1-1/2	68906
1-5/8	NBG25-1-5/8	68907
1-11/16	NBG25-1-11/16	68908
1-3/4	NBG25-1-3/4	68909
1-15/16	NBG25-1-15/16	68910
2	NBG25-2	68911
2-3/16	NBG25-2-3/16	68912
2-1/4	NBG25-2-1/4	68913
2-7/16	NBG25-2-7/16	68914

(FOR USE WITH THE SF, SH, SL AND ST SERIES BEARINGS)

MB SERIES

Bore	Catalog Number	Item Code
1-7/16	NBG35-1-7/16	68915
1-1/2	NBG35-1-1/2	68916
1-11/16	NBG35-1-11/16	68917
1-3/4	NBG35-1-3/4	68918
1-15/16	NBG35-1-15/16	68919
2	NBG35-2	68920
2-3/16	NBG35-2-3/16	68921
2-1/4	NBG35-2-1/4	68922
2-7/16	NBG35-2-7/16	68923
2-1/2	NBG35-2-1/2	68924
2-11/16	NBG35-2-11/16	68925
2-15/16	NBG25-2-15/16	68926
3	NBG35-3	68927
3-3/16	NBG35-3-3/16	68928
3-1/4	NBG35-3-1/4	68929
3-7/16	NBG35-3-7/16	68930
3-1/2	NBG35-3-1/2	68931

(FOR USE WITH THE MB, MBF AND MBP SERIES BEARINGS)

Mounted Bearings

PPB Series SRP Series – With Bost-Bronz Bushings

Pillow Blocks – Light Duty Split Cast Iron

The bottom surface and the split surfaces are ground. Both end surfaces of the bore are finished perpendicular to the base. Bolt holes in the base are slotted except Cat. No. PPB4 which has drilled holes. PPB Series blocks have an oil hole drilled in center of cap.†

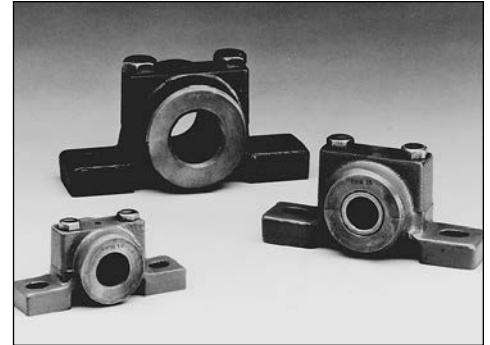

ORDER BY CATALOG NUMBER OR ITEM CODE

Bore	PPB SERIES		SRP SERIES			
	Catalog Number	Item Code	Pillow Blocks		Replacement Bearing	
			Catalog Number	Item Code	Catalog Number	Item Code
1/4	PPB4	34304	SRP4	34434	B46-2	34542
3/8	PPB6	34306	SRP6	34436	B68-3	34634
1/2	PPB8	34308	SRP8	34438	B812-4	34752
5/8	PPB10	34310	SRP10	34440	B1014-6	34852
3/4	PPB12	34312	SRP12	34442	B1216-6	34934
7/8	PPB14	34314	—	—	—	—
15/16	PPB15	34316	SRP15	34444	B1520-8	35042
1	PPB16	34318	SRP16	34446	B1620-8	35068
1-3/16	PPB19	34320	SRP19	34448	B1924-8	35172
1-1/4	PPB20	34322	SRP20	34450	B2024-8	35186
1-7/16	PPB23	34324	—	—	—	—
1-1/2	PPB24	34326	—	—	—	—

STANDARD TOLERANCES

DIMENSIONS		TOLERANCE
PPB Series		
Bore	All	+0.000 to -0.001
SRP Series		
Bore	.252-1.003	+0.000 to -0.001
	1.1905-1.2530	+0.000 to -0.002

*Two required.

†The 1/4" size is made of brass and has no oil holes.

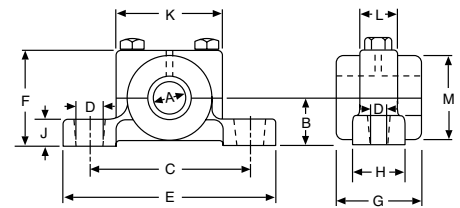

ALL DIMENSIONS IN INCHES

A (Bore)	B	C	D	E	F	G	H	J	K	L	M
PPB SERIES											
.2500	1/4	1-1/8	1/8	1-1/2	1/2	1/2	3/8	1/4	3/4	3/8	7/16
.3760	9/16	2-1/8	5/16x3/16	2-3/4	1-1/8	1	5/8	5/16	1-7/16	7/16	1
.5010											
.6260	13/16	2-7/8	1/2x5/16	3-3/4	1-5/8	1-1/2	1	1/2	2	11/16	1-1/2
.7510											
.8760											
.9385	1-1/8	3-3/4	5/8x3/8	5	2-1/4	2	1-1/4	5/8	2-1/2	7/8	2
1.0010											
1.1885											
1.2510	1-3/8	4-1/2	3/4x1/2	6	2-3/4	2-1/2	1-1/2	3/4	3	1	2-1/2
1.4385											
1.5010											
SRP SERIES											
.2510	9/16	2-1/8	5/16x3/16	2-3/4	1-1/8	1	5/8	5/16	1-7/16	7/16	1
.3770											
.5020	13/16	2-7/8	1/2x5/16	3-3/4	1-5/8	1-1/2	1	1/2	2	11/16	1-1/2
.6270	1-1/8	3-3/4	5/8x3/8	5	2-1/8	2	1-1/4	5/8	2-1/2	7/8	2
.7530											
.9405											
1.0030	1-3/8	4-1/2	3/4x1/2	6	2-3/4	2-1/2	1-1/2	3/4	3	1	2-1/2
1.1905											
1.2530											

Mounted Ball Bearings

PS Series Pressed Steel Housing Pillow Blocks – Light Duty Setscrew Locking

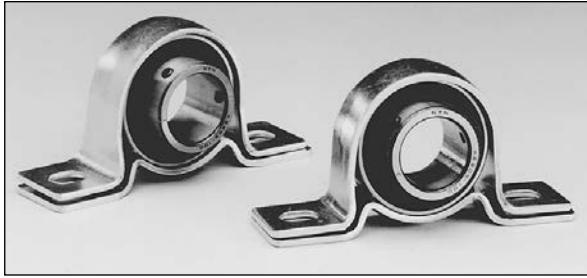

Features —

- Quality pressed steel outer housing.
- Deep groove ball bearings for high radial and thrust loads.
- Spherical outer race for full self-alignment.
- Synthetic lip type seals.
- Positive locking by setscrews through extended inner race.
- Lubricated for life.
- Housing halves snap together for ease of assembly.

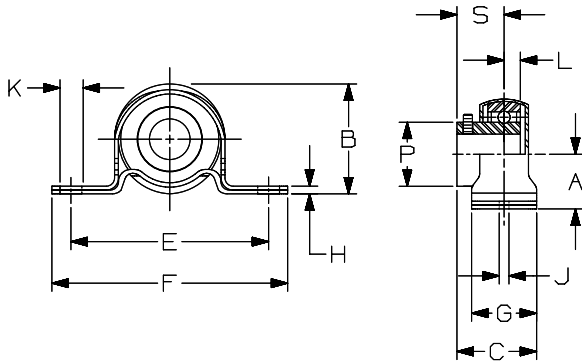

ORDER BY CATALOG NUMBER OR ITEM CODE

Bore	Catalog Number	Item Code
1/2	PS-1/2	64500
5/8	PS-5/8	64501
3/4	PS-3/4	64502
7/8	PS-7/8	64503
15/16	PS-15/16	64504
1	PS-1	64505
1-1/16	PS-1-1/16	64506
1-1/8	PS-1-1/2	64507
1-3/16	PS-1-3/16	64508
1-1/4S	PS-1-1/4S	64509

STANDARD TOLERANCES

DIMENSIONS		TOLERANCE
Bore	All	+0.001 to -0.000

ALL DIMENSIONS IN INCHES

Bore	A	B	C	E	F	G	H	J	K	L	P	R* Setscrew UNF	S	Bolt Size	Approx. Weight (Lbs.)
1/2	7/8	1-3/4	1.125	2-11/16	3-5/8	1	.133	.34	.54	15/64	31/32	10-32	5/8	5/16	.52
5/8	1	2-1/16	1.203	3	4-1/8	1	.178	.40	.54	9/32	1-11/64	10-32	45/64	5/16	.48
3/4	1	2-1/16	1.203	3	4-1/8	1	.178	.40	.54	9/32	1-11/64	10-32	45/64	5/16	.58
7/8	1-1/8	2-7/32	1.328	3-3/8	4-1/2	1-1/8	.208	.40	.54	19/64	1-11/32	10-32	49/64	3/8	.67
15/16	1-1/8	2-7/32	1.328	3-3/8	4-1/2	1-1/8	.208	.40	.54	19/64	1-11/32	10-32	49/64	3/8	.64
1	1-1/8	2-7/32	1.328	3-3/8	4-1/2	1-1/8	.208	.40	.54	19/64	1-11/32	10-32	49/64	3/8	.61
1-1/16	1-5/16	2-5/8	1.390	3-3/4	4-7/8	1-1/8	.238	.53	.75	5/16	1-39/64	1/4-28	53/64	3/8	1.10
1-1/8	1-5/16	2-5/8	1.390	3-3/4	4-7/8	1-1/8	.238	.53	.75	5/16	1-39/64	1/4-28	53/64	3/8	1.05
1-3/16	1-5/16	2-5/8	1.390	3-3/4	4-7/8	1-1/8	.238	.53	.75	5/16	1-39/64	1/4-28	53/64	3/8	1.00
1-1/4S	1-5/16	2-5/8	1.390	3-3/4	4-7/8	1-1/8	.238	.53	.75	5/16	1-39/64	1/4-28	53/64	3/8	.95

*2 at 120°

Eccentric Locking Collar bearings are available to special order.

For Load Ratings, See Engineering Section, Page 242.

Replacement Bearings are shown on Page 214.

Mounted Ball Bearings

XL Series Cast Ductile Housing Pillow Blocks – Light Duty Setscrew Locking

Features —

- One-piece housing (ductile casting).
- Deep groove ball bearings for high radial and thrust loads.
- Machined housing bore and spherical outer race for full self-alignment.
- Synthetic lip type seal.
- Positive locking by setscrews through extended inner race.



ORDER BY CATALOG NUMBER OR ITEM CODE

Bore	Catalog Number	Item Code
1/2	XL-1/2	64534
5/8	XL-5/8	64535
3/4	XL-3/4	64536
7/8	XL-7/8	64537
15/16	XL-15/16	64538
1	XL-1	64539
1-1/16	XL-1-1/16	64540
1-1/8	XL-1-1/8	64541
1-3/16	XL-1-3/16	64542
1-1/4S	XL-1-1/4S	64543
1-3/8	XL-1-3/8	64545
1-7/16	XL-1-7/16	64546

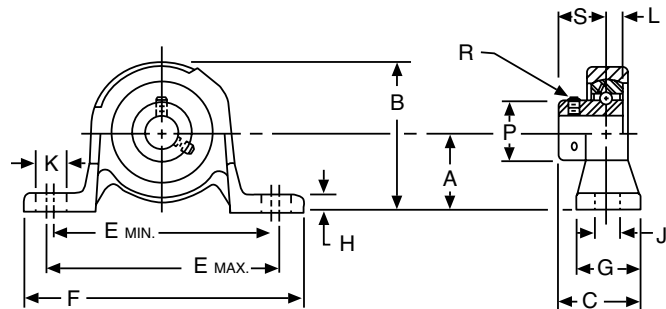

STANDARD TOLERANCES

DIMENSIONS	TOLERANCE	
Bore	All	±.001 - .000

ALL DIMENSIONS IN INCHES

Bore	A	B	C	E Min.	E Max.	F	G	H	J	K	L	P	R* Setscrew UNF	S	Bolt Size	Approx. Weight (Lbs.)
1/2 5/8	1-3/16	2-5/32	1-1/8	3-3/16	3-11/16	4-1/2	1	9/32	7/16	11/16	15/64	31/32	10-32	5/8	3/8	.6
3/4	1-5/16	2-7/16	1-15/64	3-5/8	3-7/8	4-3/4	1-1/16	5/16	7/16	9/16	9/32	1-11/64	10-32	45/64	3/8	.8
7/8 15/16 1	1-7/16	2-21/32	1-11/32	3-7/8	4-1/8	5	1-1/8	11/32	7/16	9/16	19/64	1-11/32	10-32	49/64	3/8	1.0
1-1/16 1-1/8 1-3/16 1-1/4S	1-11/16	3-5/32	1-31/64	4-1/2	4-3/4	6	1-5/16	3/8	9/16	11/16	5/16	1-39/64	1/4-28	53/64	1/2	1.4
1-3/8 1-7/16	1-7/8	3-9/16	1-11/16	4-3/4	5	6-3/8	1-3/8	13/32	9/16	11/16	11/32	1-27/32	1/4-28	1	1/2	1.9

*2 at 120°

These units also available with Eccentric Locking Collars on Special Order.

For Load Ratings, see Engineering Section, Page 237.

Replacement Bearings are shown on Page 214.

Mounted Ball Bearings

L/H Series

Pillow Blocks – Standard Duty; Eccentric Locking Collar



L Series Low Backing
H Series High Backing

Features —

- Rigid one piece housing.
- Chrome alloy steel balls.
- Spherical outer race.
- Synthetic lip type seals.
- Eccentric locking collar.
- 1/4-28 threaded grease fitting.

ORDER BY CATALOG NUMBER OR ITEM CODE

Bore	Low Backing		High Backing	
	L Series		H Series	
	Catalog Number	Item Code	Catalog Number	Item Code
1/2	3L-1/2	06906	3H-1/2	06902
5/8	3L-5/8	06908	3H-5/8	06904
3/4	4L-3/4	06912	4H-3/4	06910
7/8	5L-7/8	06920	5H-7/8	06914
15/16	5L-15/16	06922	5H-15/16	06916
1	5L-1	06924	5H-1	06918
1-1/8	6L-1-1/8	06928	6H-1-1/8	06932
1-3/16	6L-1-3/16	06930	6H-1-3/16	06936
1-1/4S	6L-1-1/4S	06934	6H-1-1/4S	06926
1-1/4	7L-1-1/4*	06858	7H-1-1/4*	06850
1-5/16	7L-1-5/16*	06860	7H-1-5/16*	06852
1-3/8	7L-1-3/8*	06862	7H-1-3/8*	06854
1-1/2	8L-1-1/2*	06868	8H-1-1/2*	06866
1-5/8	9L-1-5/8*	06876	9H-1-5/8*	06870
1-11/16	9L-1-11/16*	06878	9H-1-11/16*	06872
1-15/16	10L-1-15/16*	06884	10H-1-15/16*	06882
2-1/4	12L-2-1/4*	06898	12H-2-1/4*	06894
2-7/16	12L-2-7/16*	06900	12H-2-7/16*	06896

*Bearings equipped with steel flinger.

Replacement Bearings are shown on Page 213.

Mounted Ball Bearings

L/H Series

Pillow Blocks – Standard Duty; Eccentric Locking Collar

SHAFT HEIGHT DIMENSIONS IN INCHES

Bore	Low Backing			High Backing		
	A	B	H	A	B	H
1/2 5/8	1-1/16	2-5/32	1/2	1-3/16	2-9/32	5/8
3/4	1-1/4	2-15/32	9/16	1-5/16	2-17/32	5/8
7/8 15/16 1	1-5/16	2-21/32	5/8	1-7/16	2-25/32	3/4
1-1/8 1-3/16 1-1/4S	1-9/16	3-1/8	3/4	1-11/16	3-1/4	7/8
1-1/4 1-5/16 1-3/8 1-7/16	1-13/16	3-11/16	1	1-7/8	3-3/4	1-1/16
1-1/2	1-15/16	4	1-1/8	2	4-1/16	1-3/16
1-5/8 1-11/16 1-3/4	2-1/16	4-1/4	1-1/4	2-1/8	4-5/16	1-5/16
1-15/16	2-3/16	4-1/2	1-3/8	2-1/4	4-9/16	1-7/16
2 2-3/16	2-7/16	4-15/16	1-1/2	2-1/2	5	1-9/16
2-1/4 2-7/16	2-11/16	5-7/16	1-5/8	2-3/4	5-1/2	1-11/16

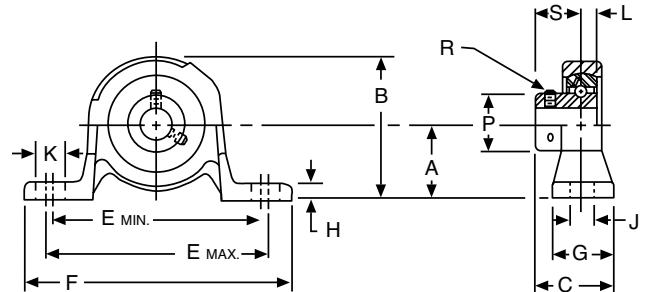

STANDARD TOLERANCES

DIMENSIONS		TOLERANCE
Bore	All	+0.0012 to -0.0000

ALL DIMENSIONS IN INCHES

Bore	C	E		F	G	J	K	L	P	R Setscrew UNF	S	Bolt Size	Approx. Wt. (Lbs.)	
		Min.	Max.										L	H
1/2 5/8	1-5/8	3-5/16	4	5-1/16	1-1/2	7/16	25/32	1/4	1-9/64	1/4-28	7/8	3/8	1.1	1.2
3/4	1-45/64	3-7/16	4-1/8	5-1/4	1-9/16	7/16	25/32	19/64	1-19/64	1/4-28	59/64	3/8	1.6	1.6
7/8 15/16 1	1-47/64	3-7/16	4-1/4	5-1/2	1-5/8	7/16	11/16	19/64	1-1/2	1/4-28	59/64	3/8	1.9	1.9
1-1/8 1-3/16 1-1/4S	1-59/64	4-5/16	4-15/16	6-1/4	1-3/4	9/16	7/8	23/64	1-3/4	5/16-24	1-3/64	1/2	2.6	2.7
1-1/4 1-5/16 1-3/8 1-7/16	2-13/64	4-3/4	5-3/8	6-11/16	1-7/8	9/16	7/8	47/64	2-3/16	3/8-24	1-17/64	1/2	4.1	4.3
1-1/2	2-3/8	5-1/4	5-13/16	7-1/4	2	9/16	27/32	27/32	2-23/64	3/8-24	1-3/8	1/2	5.5	5.6
1-5/8 1-11/16 1-3/4	2-7/16	5-9/16	6-1/8	7-3/4	2-1/8	9/16	27/32	27/32	2-1/2	3/8-24	1-3/8	1/2	6.5	6.6
1-15/16	2-5/8	6-1/16	6-5/8	8-1/4	2-1/4	11/16	31/32	31/32	2-3/4	3/8-24	1-1/2	5/8	8.0	8.1
2 2-3/16	2-29/32	6-7/16	7-3/8	8-7/8	2-3/8	11/16	1-5/32	1-3/32	3	7/16-20	1-23/32	5/8	9.5	10.0
2-1/4 2-7/16	3-3/32	6-15/16	7-7/8	9-5/8	2-1/2	11/16	1-5/32	1-7/32	3-5/16	7/16-20	1-27/32	5/8	11.8	11.9

For Load Ratings, see Engineering Section, Page 243.

Mounted Ball Bearings

SL/SH Series

Pillow Blocks – Standard Duty; Extended Inner Race – Setscrew Locking



SL Series Low Backing
SH Series High Backing

Features —

- One-piece, high grade cast iron housing.
- Deep groove ball bearings for high radial and thrust loads.
- Precision machined housing bore and spherical outer race for self-alignment.
- Synthetic lip type seals with steel flinger.
- Positive locking by setscrews through extended inner race.
- 1/4-28 threaded grease fitting and channel through outer race allow relubrication.

ORDER BY CATALOG NUMBER OR ITEM CODE

Bore	Low Backing		High Backing	
	Catalog Number	Item Code	Catalog Number	Item Code
1/2	SL-1/2*	64680	SH-1/2*	64679
5/8	SL-5/8*	64682	SH-5/8*	64681
3/4	SL-3/4	64684	SH-3/4	64683
7/8	SL-7/8	64686	SH-7/8	64685
15/16	SL-15/16	64688	SH-15/16	65687
1	SL-1	64690	SH-1	64689
1-1/8	SL-1-1/8	64692	SH-1-1/8	64691
1-3/16	SL-1-3/16	64694	SH-1-3/16	64693
1-1/4S	SL-1-1/4S	64696	SH-1-1/4S	64695
1-1/4	SL-1-1/4	64698	SH-1-1/4	64697
1-5/16	SL-1-5/16	64700	SH-1-5/16	64699
1-3/8	SL-1-3/8	64702	SH-1-3/8	64701
1-7/16	SL-1-7/16	64704	SH-1-7/16	64703
1-1/2	SL-1-1/2	64706	SH-1-1/2	64705
1-5/8	SL-1-5/8	64708	SH-1-5/8	64707
1-11/16	SL-1-11/16	64710	SH-1-11/16	64709
1-3/4	SL-1-3/4	64712	SH-1-3/4	64711
1-15/16	SL-1-15/16	64714	SH-1-15/16	64713
2	SL-2	64716	SH-2	64715
2-3/16	SL-2-3/16	64718	SH-2-3/16	64717
2-1/4	SL-2-1/4	64720	SH-2-1/4	64719
2-7/16	SL-2-7/16	64722	SH-2-7/16	64721

*Bearings not equipped with steel flinger.
 Replacement Bearings are shown on Page 214.

Mounted Ball Bearings

SL/SH Series

Pillow Blocks – Standard Duty; Extended Inner Race
– Setscrew Locking

SHAFT HEIGHT DIMENSIONS IN INCHES

Bore	Low Backing			High Backing		
	A	B	H	A	B	H
1/2 5/8	1-1/16	2-5/32	1/2	1-3/16	2-9/32	5/8
3/4	1-1/4	2-15/32	9/16	1-5/16	2-17/32	5/8
7/8 15/16 1	1-5/16	2-21/32	5/8	1-7/16	2-25/32	3/4
1-1/8 1-3/16 1-1/4S	1-9/16	3-1/8	3/4	1-11/16	3-1/4	7/8
1-1/4 1-5/16 1-3/8 1-7/16	1-13/16	3-11/16	1	1-7/8	3-3/4	1-1/16
1-1/2	1-15/16	4	1-1/8	2	4-1/16	1-3/16
1-5/8 1-11/16 1-3/4	2-1/16	4-1/4	1-1/4	2-1/8	4-5/16	1-5/16
1-15/16	2-3/16	4-1/2	1-3/8	2-1/4	4-9/16	1-7/16
2 2-3/16	2-7/16	4-15/16	1-1/2	2-1/2	5	1-9/16
2-1/4 2-7/16	2-11/16	5-7/16	1-5/8	2-3/4	5-1/2	1-11/16

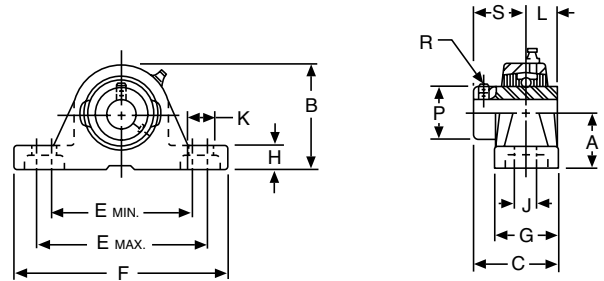

STANDARD TOLERANCES

DIMENSIONS	TOLERANCE
Bore	All
	+0.0012 to -0.0000

ALL DIMENSIONS IN INCHES

Bore	C	E		F	G	J	K	L	P	R* Setscrew (UNF)	S	Bolt Size	Approx. Wt. (Lbs.)	
		Min.	Max.										L	H
1/2 5/8	1-3/8	3-5/16	4	5-1/16	1-1/2	7/16	25/32	9/32	31/32	10-32	5/8	3/8	1.25	1.38
3/4	1-1/2	3-7/16	4-1/8	5-1/4	1-9/16	7/16	25/32	1/2	1-11/64	10-32	23/32	3/8	1.75	1.75
7/8 15/16 1	1-37/64	3-3/4	4-1/4	5-1/2	1-5/8	7/16	11/16	9/16	1-21/64	10-32	25/32	3/8	2.00	2.00
1-1/8 1-3/16 1-1/4S	1-3/4	4-5/16	4-15/16	6-1/4	1-3/4	9/16	7/8	5/8	1-39/64	1/4-28	7/8	3/8	2.75	2.88
1-1/4 1-5/16 1-3/8 1-7/16	1-15/16	4-3/4	5-3/8	6-11/16	1-7/8	9/16	7/8	11/16	1-27/32	1/4-28	1	1/2	4.25	4.50
1-1/2	2-3/16	5-1/4	5-13/16	7-1/4	2	9/16	27/32	3/4	2-3/32	5/16-24	1-3/16	1/2	5.63	5.75
1-5/8 1-11/16 1-3/4	2-33/64	5-9/16	6-1/8	7-3/4	2-1/8	9/16	27/32	3/4	2-17/64	5/16-24	1-3/16	1/2	6.63	6.75
1-15/16	2-13/32	6-1/16	6-5/8	8-1/4	2-1/4	11/16	31/32	3/4	2-29/64	5/16-24	1-5/16	5/8	8.25	8.25
2 2-3/16	2-1/2	6-7/16	7-3/8	8-7/8	2-3/8	11/16	1-5/32	7/8	2-23/32	5/16-24	1-5/16	5/8	10.00	10.25
2-1/4 2-7/16	2-13/16	6-15/16	7-7/8	9-5/8	2-1/2	11/16	1-5/32	1	3-1/32	3/8-24	1-9/16	5/8	12.25	12.38

*2 at 120°

For Load Ratings, see Engineering Section, Page 243.

Mounted Ball Bearings

MB Series

Pillow Blocks – Medium Duty; Extended Inner Race – Setscrew Locking



Features —

- One-piece high grade cast iron housing.
- Deep groove ball bearings for high radial and thrust loads.
- Precision machined housing bore and spherical race for full self-alignment.
- Synthetic lip type seal with steel flinger.
- Positive locking by setscrews through extended inner race.
- 1/4-28 threaded grease fitting and channel through outer race allow relubrication.

ORDER BY CATALOG NUMBER OR ITEM CODE

Bore	Catalog Number	Item Code
1-7/16	MB-1-7/16	64573
1-1/2	MB-1-1/2	64574
1-11/16	MB-1-11/16	64575
1-3/4	MB-1-3/4	64576
1-15/16	MB-1-15/16	64577
2	MB-2	64578
2-3/16	MB-2-3/16	64579
2-1/4	MB-2-1/4	64580
2-7/16	MB-2-7/16	64581
2-1/2	MB-2-1/2	64582
2-11/16	MB-2-11/16	64583
2-15/16	MB-2-15/16	64584
3	MB-3	64585
3-3/16	MB-3-3/16	64586
3-1/4	MB-3-1/4	64587
3-7/16	MB-3-7/16	64588
3-1/2	MB-3-1/2	64589

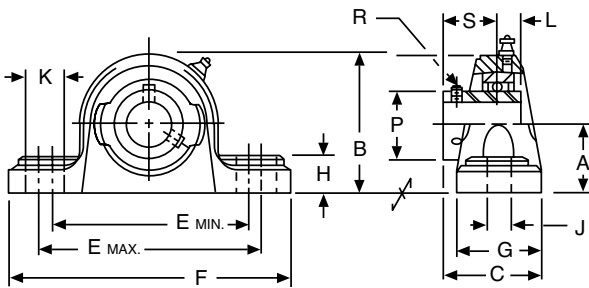

STANDARD TOLERANCES

DIMENSIONS		TOLERANCE
Bore	All	+0.001 to -0.000

ALL DIMENSIONS IN INCHES

Bore	A	B	C	E Min.	E Max.	F	G	H	J	K	L	P	R* Setscrew (UNF)	S	Bolt Size	Approx. Weight (Lbs.)
1-7/16	2-1/8	4-3/16	2-17/64	5-1/16	6-5/16	6-1/2	2-1/4	3/4	9/16	1-3/16	3/4	1-27/32	5/16-24	1-9/64	1/2	6.8
1-1/2	2-5/16	4-9/16	2-1/2	5-9/16	6-11/16	8-1/4	2-5/8	13/16	11/16	1-1/4	3/4	2-3/32	5/16-24	1-3/16	5/8	9.0
1-11/16 1-3/4	2-5/16	4-5/8	2-19/32	5-1/2	6-3/4	8-1/4	2-5/8	13/16	11/16	1-5/16	3/4	2-17/64	5/16-24	1-9/32	5/8	9.5
1-15/16 2	2-1/2	5-1/16	2-3/4	6	7-1/2	8-7/8	2-7/8	7/8	11/16	1-7/16	7/8	2-23/32	5/16-24	1-5/16	5/8	11.7
2-3/16 2-1/4	2-3/4	5-5/8	3-1/8	6-5/8	7-7/8	9-5/8	3-1/8	1-1/16	13/16	1-7/16	1	3-1/32	3/8-24	1-9/16	3/4	16.2
2-7/16 2-1/2	3	6-3/16	3-3/8	7-3/16	8-13/16	10-3/8	3-1/4	1-1/16	13/16	1-5/8	1-3/16	3-27/64	3/8-24	1-3/4	3/4	21.5
2-11/16	3-1/2	6-15/16	3-3/8	7-15/16	10-1/16	11-7/8	3-1/2	1-1/8	15/16	2	1-5/16	3-43/64	3/8-24	1-3/4	7/8	29.2
2-15/16 3	3-1/2	7-1/8	3-11/16	7-15/16	10-1/16	11-7/8	3-1/2	1-1/4	15/16	2	1-5/16	3-7/8	1/2-20	1-15/16	7/8	31.5
3-3/16 3-1/4	4	8	4-1/32	9-3/4	12-1/2	15	4	1-1/4	15/16	2-5/16	1-11/32	4-3/16	1/2-20	2-1/32	7/8	41.1
3-7/16 3-1/2	4	8-1/4	4-13/32	9-11/16	12-9/16	15	4-3/8	1-5/16	15/16	2-3/8	1-9/16	4-25/64	1/2-20	2-7/32	7/8	47.8

*2 at 120°

For Load Ratings, See Engineering Section, Page 243.

Replacement Bearings are shown on Page 214.

Mounted Ball Bearings

PS2/PS3 Series Pressed Steel Housing Flanged Units – Light Duty; Setscrew Locking

ORDER BY CATALOG NUMBER OR ITEM CODE

Bore	3-BOLT		2-BOLT	
	Catalog Number	Item Code	Catalog Number	Item Code
1/2	PS3-1/2	64520	PS2-1/2	64510
5/8	PS3-5/8	64521	PS2-5/8	64511
3/4	PS3-3/4	64522	PS2-3/4	64512
7/8	PS3-7/8	64523	PS2-7/8	64513
15/16	PS3-15/16	64524	PS2-15/16	64514
1	PS3-1	64525	PS2-1	64515
1-1/16	PS3-1-1/16	64526	PS2-1-1/16	64516
1-1/8	PS3-1-1/8	64527	PS2-1-1/8	64517
1-3/16	PS3-1-3/16	64528	PS2-1-3/16	64518
1-1/4S	PS3-1-1/4S	64529	PS2-1-1/4S	64519
1-1/4	PS3-1-1/4	64530	-----	-----
1-3/8	PS3-1-3/8	64532	-----	-----
1-7/16	PS3-1-7/16	64533	-----	-----

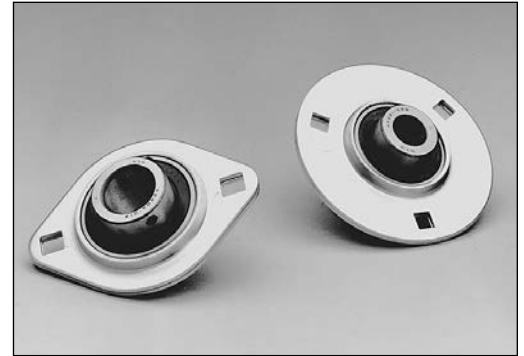

STANDARD TOLERANCES

DIMENSIONS		TOLERANCE
Bore	All	+ .001 to -.0000

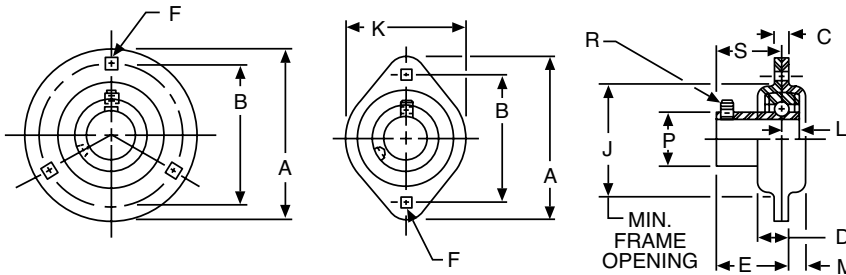

ALL DIMENSIONS IN INCHES

Bore	A	B	C	D	E	F Sq.	J	K	L	M	P	R* Setscrew UNF	S	Bolt Size	Approx. Weight (Lbs.)	
															PS3	PS2
1/2	3-3/16	2-1/2	.150	23/64	45/64	9/32	1-15/16	2-5/16	15/64	13/64	31/32	10-32	5/8	1/4	.63	.51
5/8	3-3/16	2-1/2	.150	23/64	45/64	9/32	1-15/16	2-5/16	15/64	13/64	31/32	10-32	5/8	1/4	.59	.47
3/4	3-9/16	2-13/16	.166	25/64	25/32	11/32	2-3/16	2-5/8	9/32	7/32	1-11/64	10-32	45/64	5/16	.74	.60
7/8	3-3/4	3	.166	27/64	27/32	11/32	2-3/8	2-51/64	19/64	1/4	1-11/32	10-32	49/64	5/16	.87	.70
15/16	3-3/4	3	.166	27/64	27/32	11/32	2-3/8	2-51/64	19/64	1/4	1-11/32	10-32	49/64	5/16	.84	.67
1	3-3/4	3	.166	27/64	27/32	11/32	2-3/8	2-51/64	19/64	1/4	1-11/32	10-32	49/64	5/16	.81	.64
1-1/16	4-7/16	3-9/16	.208	29/64	15/16	13/32	2-13/16	3-5/16	5/16	1/4	1-39/64	1/4-28	53/64	3/8	1.42	1.08
1-1/8	4-7/16	3-9/16	.208	29/64	15/16	13/32	2-13/16	3-5/16	5/16	1/4	1-39/64	1/4-28	53/64	3/8	1.37	1.03
1-3/16	4-7/16	3-9/16	.208	29/64	15/16	13/32	2-13/16	3-5/16	5/16	1/4	1-39/64	1/4-28	53/64	3/8	1.32	.98
1-1/4S	4-7/16	3-9/16	.208	29/64	15/16	13/32	2-13/16	3-5/16	5/16	1/4	1-39/64	1/4-28	53/64	3/8	1.27	.93
1-1/4	4-13/16	3-15/16	.208	31/64	1-7/64	13/32	3-3/16	—	11/32	9/32	1-27/32	1/4-28	1	3/8	1.93	—
1-3/8	4-13/16	3-15/16	.208	31/64	1-7/64	13/32	3-3/16	—	11/32	9/32	1-27/32	1/4-28	1	3/8	1.84	—
1-7/16	4-13/16	3-15/16	.208	31/64	1-7/64	13/32	3-3/16	—	11/32	9/32	1-27/32	1/4-28	1	3/8	1.74	—

*2 at 120°

Eccentric Locking Collar bearings are available to special order.

On 1-1/4" through 1-7/16" Hole Diameters, Eccentric Collar bearings will have extended inner races on both sides and will project beyond "M" dimension.

For Load Ratings, see Engineering Section, Page 242.

Replacement Bearings are shown on Page 214.

Mounted Ball Bearings

XL2/XL3 Series Cast Ductile Housing Flanged Units – Light Duty; Setscrew Locking

F



ORDER BY CATALOG NUMBER OR ITEM CODE

Bore	3-BOLT		2-BOLT	
	Catalog Number	Item Code	Catalog Number	Item Code
1/2	XL3-1/2	64560	XL2-1/2	64547
5/8	XL3-5/8	64561	XL2-5/8	64548
3/4	XL3-3/4	64562	XL2-3/4	64549
7/8	XL3-7/8	64563	XL2-7/8	64550
15/16	XL3-15/16	64564	XL2-15/16	64551
1	XL3-1	64565	XL2-1	64552
1-1/16	XL3-1-1/16	64566	XL2-1-1/16	64553
1-1/8	XL3-1-1/8	64567	XL2-1-1/8	64554
1-3/16	XL3-1-3/16	64568	XL2-1-3/16	64555
1-1/4S	XL3-1-1/4S	64569	XL2-1-1/4S	64556
1-3/8	XL3-1-3/8	64571	XL2-1-3/8	64558
1-7/16	XL3-1-7/16	64572	XL2-1-7/16	64559

STANDARD TOLERANCES

DIMENSIONS		TOLERANCE
Bore	All	+ .001 to - .000

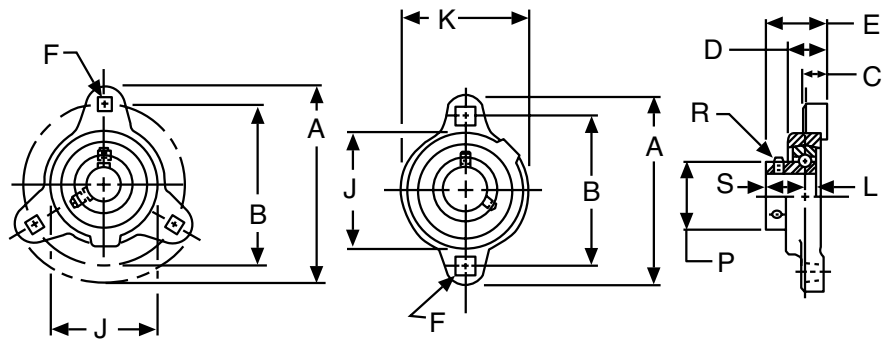

ALL DIMENSIONS IN INCHES

Bore	A	B	C	D	E	F Sq.	J	K	L	P	R* Setscrew UNF	S	Bolt Size	Approx. Weight (Lbs.)	
														XL3	XL2
1/2 5/8	3-3/16	2-1/2	27/64	11/16	1	9/32	1-13/16	1-15/16	15/64	31/32	10-32	5/8	1/4	.6	.5
3/4	3-9/16	2-13/16	7/16	3/4	1-1/8	11/32	2-1/16	2-1/4	9/32	1-11/64	10-32	45/64	3/16	.7	.7
7/8 15/16 1	3-3/4	3	7/16	3/4	1-1/8	11/32	2-5/16	2-1/2	19/64	1-11/32	10-32	49/64	5/16	.8	.8
1-1/16 1-1/8 1-3/16 1-1/4S	4-7/16	3-9/16	15/32	27/32	1-19/64	13/32	2-13/16	2-15/16	5/16	1-39/64	1/4-28	53/64	3/8	1.2	1.2
1-3/8 1-7/16	4-13/16	3-15/16	1/2	29/32	1-1/2	13/32	3-3/16	3-3/8	11/32	1-27/32	1/4-28	1	3/8	1.6	1.5

*2 at 120°

These units also available with Eccentric Locking Collars on Special Order.

For Load Ratings, See Engineering Section, Page 243.

Replacement Bearings are shown on Page 214.

Mounted Ball Bearings

F/T Series

Flanged Units – Standard Duty; Eccentric Locking Collar

F Series 4-Bolt T Series 2-Bolt

Features —

- Rigid one-piece high housing.
- Chrome alloy steel balls. Spherical outer race.
- Synthetic lip type seals.
- Eccentric locking collar.
- 1/4-28 threaded grease fitting.



F

ORDER BY CATALOG NUMBER OR ITEM CODE

Bore	4-BOLT FLANGES F SERIES		2-BOLT FLANGES T SERIES	
	Catalog Number	Item Code	Catalog Number	Item Code
1/2	3F-1/2	06938	3T-1/2	06982
5/8	3F-5/8	06940	3T-5/8	06984
3/4	4F-3/4	06942	4T-3/4	06986
7/8	5F-7/8	06944	5T-7/8	06988
15/16	5F-15/16	06946	5T-15/16	06990
1	5F-1	06948	5T-1	06992
1-1/8	6F-1-1/8	06950	6T-1-1/8	06994
1-3/16	6F-1-3/16	06952	6T-1-3/16	06996
1-1/4S	6F-1-1/4S	06954	6T-1-1/4S	06998
1-1/4	7F-1-1/4*	06956	7T-1-1/4*	07000
1-5/16	7F-1-5/16*	06958	7T-1-5/16*	07002
1-3/8	7F-1-3/8*	06960	7T-1-3/8*	07004
1-7/16	7F-1-7/16*	06962	7T-1-7/16*	07006
1-1/2	8F-1-1/2*	06964	—	—
1-5/8	9F-1-5/8*	06966	—	—
1-11/16	9F-1-11/16*	06968	—	—
1-3/4	9F-1-3/4*	06970	—	—
1-15/16	10F-1-15/16*	06972	10T-1-15/16*	50695
2	11F-2*	06974	—	—
2-3/16	11F-2-3/16*	06976	—	—
2-1/4	12F-2-1/4*	06978	—	—
2-7/16	12F-2-7/16*	06980	—	—

*Bearings equipped with steel flinger.

Replacement Bearings are shown on Page 213.

Mounted Ball Bearings

F/T Series

Flanged Units – Standard Duty; Eccentric Locking Collar

F

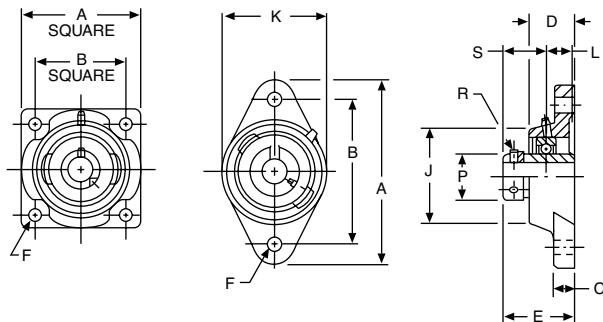

STANDARD TOLERANCES

DIMENSIONS		TOLERANCE
Bore	All	+0.0012 to -0.0000

ENVELOPE AND BOLT SPACING DIMENSIONS IN INCHES

Bore	4-BOLT		2-BOLT		
	A	B	A	B	K
1/2	2-7/8	2-1/8	3-3/4	3	2-9/32
5/8					
3/4	3-3/8	2-1/2	4-13/32	3-17/32	2-37/64
7/8	3-3/4	2-3/4	4-57/64	3-57/64	2-53/64
15/16					
1	4-1/4	3-1/4	5-19/32	4-19/32	3-19/64
1-1/8					
1-3/16					
1-1/4S					
1-1/4	4-5/8	3-5/8	6-1/8	5-1/8	3-11/64
1-5/16					
1-3/8					
1-7/16					
1-1/2					
1-5/8	5-3/8	4-1/8	—	—	—
1-11/16					
1-3/4					
1-15/16	5-5/8	4-3/8	7-7/16	6-3/16	4-9/16
2	6-3/8	5-1/8	—	—	—
2-3/16					
2-1/4	6-7/8	5-5/8	—	—	—
2-7/16					

ALL DIMENSIONS IN INCHES

Bore	C	D	E	F Bolt	J	L	P	R* Setscrew UNF	S	Approx. Weight (Lbs.)	
							F T			F	T
1/2	7/16	1-1/16	1-37/64	3/8	2	1/4	1-9/64	1/4-28	7/8	.9	.9
5/8	1/2	1-7/32	1-13/16	3/8	2-1/4	19/64	1-19/64	1/4-28	59/64	1.7	1.2
3/4											
7/8	9/16	1-1/4	1-27/32	7/16	2-1/2	19/64	1-1/2	1/4-28	59/64	2.0	1.6
15/16											
1	9/16	1-11/32	2	7/16	2-15/16	23/64	1-3/4	5/16-24	1-3/64	2.7	2.1
1-1/8											
1-3/16											
1-1/4S											
1-1/4	5/8	1-3/8	2-1/8	1/2	3-1/4	47/64	2-3/16	3/8-24	1-17/64	3.7	2.8
1-5/16											
1-3/8											
1-7/16											
1-1/2	11/16	1-37/64	2-11/32	1/2	3-3/4	27/32	2-23/64	3/8-24	1-3/8	5.0	—
1-5/8	11/16	1-39/64	2-11/32	9/16	3-7/8	27/32	2-1/2	3/8-24	1-3/8	5.4	—
1-11/16											
1-3/4											
1-15/16	11/16	1-51/64	2-19/32	9/16	4-1/8	31/32	2-3/4	3/8-24	1-1/2	6.0	4.8
2	3/4	1-31/32	2-15/16	5/8	4-1/2	1-3/32	3	7/16-20	1-23/32	8.4	—
2-3/16											
2-1/4	3/4	2-1/8	3-3/16	5/8	4-7/8	1-7/32	3-5/16	7/16-20	1-27/32	10.0	—
2-7/16											

*2 at 120°.

For Load Ratings, See Engineering Section, Page 243.

Mounted Ball Bearings

SF/ST Series

Flanged Units – Standard Duty; Extended Inner Race – Setscrew Locking

SF Series 4-Bolt ST Series 2-Bolt

Features —

- One-piece high grade cast iron housing.
- Deep groove ball bearings for high radial and thrust loads.
- Precision machined housing bore and spherical outer race for self-alignment.
- Synthetic lip type seal with steel flinger.
- Positive locking by setscrews through extended inner race.
- 1/4-28 threaded grease fitting and channel through outer race allow relubrication.



F

ORDER BY CATALOG NUMBER OR ITEM CODE

Bore	4-BOLT		2-BOLT	
	Catalog Number	Item Code	Catalog Number	Item Code
1/2	SF-1/2	64736	ST-1/2	64723
5/8	SF-5/8	64737	ST-5/8	64724
3/4	SF-3/4	64738	ST-3/4	64725
7/8	SF-7/8	64739	ST-7/8	64726
15/16	SF-15/16	64740	ST-15/16	64727
1	SF-1	64741	ST-1	64728
1-1/8	SF-1-1/8	64742	ST-1-1/8	64729
1-3/16	SF-1-3/16	64743	ST-1-3/16	64730
1-1/4S	SF-1-1/4S	64744	ST-1-1/4S	64731
1-1/4	SF-1-1/4	64745	ST-1-1/4	64732
1-3/8	SF-1-3/8	64747	ST-1-3/8	64734
1-7/16	SF-1-7/16	64748	ST-1-7/16	64735
1-1/2	SF-1-1/2	64749	—	—
1-5/8	SF-1-5/8	64750	—	—
1-11/16	SF-1-11/16	64751	—	—
1-3/4	SF-1-3/4	64752	—	—
1-15/16	SF-1-15/16	64753	ST-1-15/16	50696
2	SF-2	64754	—	—
2-3/16	SF-2-3/16	64755	—	—
2-1/4	SF-2-1/4	64756	—	—
2-7/16	SF-2-7/16	64757	—	—

Replacement Bearings are shown on Page 214.

Mounted Ball Bearings

SF/ST Series

Flanged Units – Standard Duty; Extended Inner Race – Setscrew Locking

F

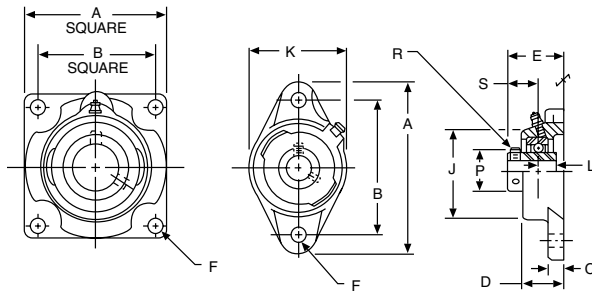

STANDARD TOLERANCES

DIMENSIONS		TOLERANCE
Bore	All	+0.0012 to -0.0000

ENVELOPE AND BOLT SPACING DIMENSIONS IN INCHES

Bore	4-BOLT		2-BOLT		
	A	B	A	B	K
1/2 5/8	2-7/8	2-1/8	3-3/4	3	2-9/32
3/4	3-3/8	2-1/2	4-13/32	3-17/32	2-37/64
7/8 15/16 1	3-3/4	2-3/4	4-57/64	3-57/64	2-53/64
1-1/8 1-3/16 1-1/4S	4-1/4	3-1/4	5-19/32	4-19/32	3-19/64
1-1/4 1-5/16 1-3/8 1-7/16	4-5/8	3-5/8	6-1/8	5-1/8	3-11/64
1-1/2	5-1/8	4	—	—	—
1-5/8 1-11/16 1-3/4	5-3/8	4-1/8	—	—	—
1-15/16	5-5/8	4-3/8	7-7/16	6-3/16	4-9/16
2 2-3/16	6-3/8	5-1/8	—	—	—
2-1/4 2-7/16	6-7/8	5-5/8	—	—	—

ALL DIMENSIONS IN INCHES

Bore	C	D	E	F Bolt	J	L	P	R* Setscrew UNF	S	Approx. Weight (Lbs.)	
										SF	ST
1/2 5/8	7/16	1-1/16	1-17/64	3/8	2	9/32	31/32	10-32	5/8	.9	.9
3/4	1/2	1-7/32	1-31/64	3/8	2-1/4	1/2	1-11/64	10-32	23/32	1.7	1.2
7/8 15/16 1	9/16	1-1/4	1-9/16	7/16	2-1/2	9/16	1-11/32	10-32	25/32	2.0	1.6
1-1/8 1-3/16 1-1/4S	9/16	1-11/32	1-11/16	7/16	2-15/16	5/8	1-39/64	1/4-28	7/8	2.7	2.1
1-1/4 1-5/16 1-3/8 1-7/16	5/8	1-3/8	1-27/32	1/2	3-5/16	11/16	1-27/32	1/4-28	1	3.7	2.8
1-1/2	11/16	1-37/64	2-1/64	1/2	3-3/4	3/4	2-3/32	5/16-24	1-3/16	5.0	—
1-5/8 1-11/16 1-3/4	11/16	1-39/64	2-1/64	9/16	3-7/8	3/4	2-17/64	5/16-24	1-3/16	5.4	—
1-15/16	11/16	1-51/64	2-3/8	9/16	4-1/8	3/4	2-29/64	5/16-24	1-9/32	6.0	4.8
2 2-3/16	3/4	1-31/32	2-17/32	5/8	4-1/2	7/8	2-23/32	5/16-24	1-5/16	8.4	—
2-1/4 2-7/16	3/4	2-1/8	2-29/32	5/8	4-7/8	1	3-1/32	3/8-24	1-9/16	10.0	—

*2 AT 120°

For Load Ratings, See Engineering Section, Page 243.

Mounted Ball Bearings

MBF Series

Flanged Units – Medium Duty; Extended Inner Race – Setscrew Locking

Features —

- One-piece high grade cast iron housing.
- Deep groove ball bearings for high radial and thrust loads.
- Precision machined housing bore and spherical outer race for full self-alignment.
- Synthetic lip type seal with steel flinger.
- Positive locking by setscrews through extended inner race.
- 1/4-28 threaded grease fitting and channel through outer race allow relubrication.

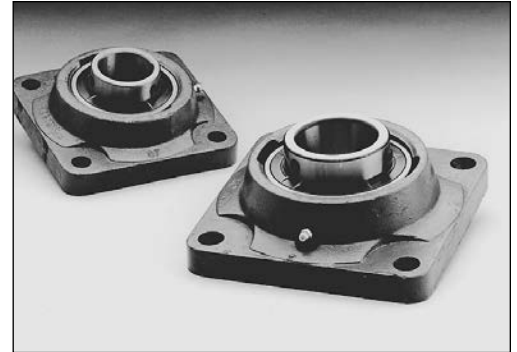

ORDER BY CATALOG NUMBER OR ITEM CODE

Bore	Catalog Number	Item Code
1-7/16	MBF-1-7/16	64590
1-1/2	MBF-1-1/2	64591
1-11/16	MBF-1-11/16	64592
1-3/4	MBF-1-3/4	64593
1-15/16	MBF-1-15/16	64594
2	MBF-2	64595
2-3/16	MBF-2-3/16	64596
2-1/4	MBF-2-1/4	64597
2-7/16	MBF-2-7/16	64598
2-1/2	MBF-2-1/2	64599
2-11/16	MBF-2-11/16	64600
2-15/16	MBF-2-15/16	64601
3	MBF-3	64602
3-3/16	MBF-3-3/16	64603
3-1/4	MBF-3-1/4	64604
3-7/16	MBF-3-7/16	64605
3-1/2	MBF-3-1/2	64606

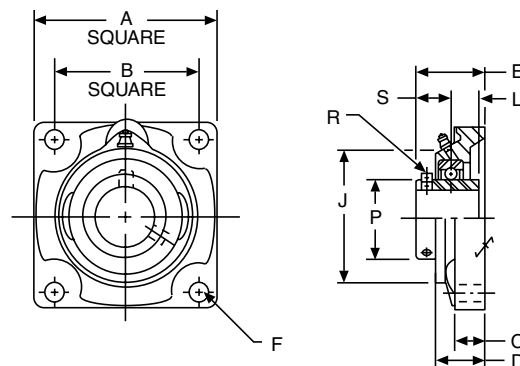

STANDARD TOLERANCES

DIMENSIONS		TOLERANCE
Bore	1-7/16-1-3/4	+0.010 to -0.000
	1-15/16-3-1/2	+0.012 to -0.000

ALL DIMENSIONS IN INCHES

Bore	A	B	C	D	E	F Bolt	J	L	P	R* Setscrew UNF	S	Approx. Weight (Lbs.)
1-7/16	5-1/8	4	11/16	1-37/64	2-5/32	1/2	3-3/4	3/4	1-27/32	5/16-24	1-9/64	5.5
1-1/2	5-3/8	4-1/8	11/16	1-39/64	2-5/32	9/16	3-7/8	3/4	2-3/32	5/16-24	1-3/16	6.0
1-11/16 1-3/4	5-5/8	4-3/8	11/16	1-51/64	2-3/8	9/16	4-1/8	3/4	2-17/64	5/16-24	1-9/32	6.8
1-15/16 2	6-3/8	5-1/8	3/4	1-31/32	2-17/32	5/8	4-1/2	7/8	2-23/32	5/16-24	1-5/16	10.5
2-3/16 2-1/4	6-7/8	5-5/8	3/4	2-1/8	2-29/32	5/8	4-7/8	1	3-1/32	3/8-24	1-9/16	12.1
2-7/16 2-1/2	7-1/8	5-7/8	3/4	2-5/32	3-1/16	5/8	5-3/4	1-3/16	3-27/64	3/8-24	1-3/4	16.4
2-11/16	7-5/8	6	3/4	2-5/16	3-3/16	3/4	5-3/4	1-5/16	3-43/64	3/8-24	1-3/4	20.6
2-15/16 3	7-5/8	6	13/16	2-7/16	3-1/2	3/4	6-1/4	1-5/16	3-7/8	1/2-20	1-15/16	21.4
3-3/16 3-1/4	8-3/8	6-3/4	15/16	2-13/32	3-17/32	3/4	6-7/8	1-11/32	4-3/16	1/2-20	2-1/32	26.7
3-7/16 3-1/2	8-3/8	6-3/4	15/16	2-11/16	3-31/32	3/4	7	1-9/16	4-25/64	1/2-20	2-7/32	20.0

*2 AT 120°

For Load Ratings, See Engineering Section, Page 243.
Replacement Bearings are shown on Page 214.

Mounted Ball Bearings

MBP Series

Piloted Flanged Units – Medium Duty; Extended Inner Race – Setscrew Locking

F



Features —

- One-piece high grade cast iron housing.
- Deep groove ball bearings for high radial and thrust loads.
- Precision machined housing bore and spherical outer race for full self-alignment.
- Synthetic lip type seal with steel flinger.
- Positive locking by setscrews through extended inner race.
- 1/4-28 threaded grease fitting and channel through outer race allow relubrication.

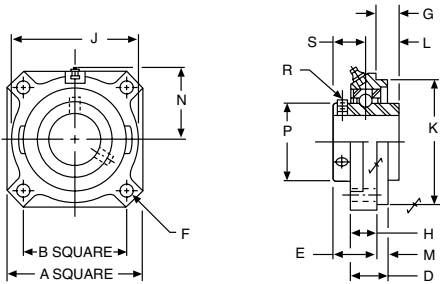

ORDER BY CATALOG NUMBER OR ITEM CODE

Bore	Catalog Number	Item Code
1-7/16	MBP-1-7/16	64607
1-1/2	MBP-1-1/2	64608
1-11/16	MBP-1-11/16	64609
1-3/4	MBP-1-3/4	64610
1-15/16	MBP-1-15/16	64611
2	MBP-2	64612
2-3/16	MBP-2-3/16	64613
2-1/4	MBP-2-1/4	64614
2-7/16	MBP-2-7/16	64615
2-1/2	MBP-2-1/2	64616
2-11/16	MBP-2-11/16	64617
2-15/16	MBP-2-15/16	64618
3	MBP-3	64619
3-7/16	MBP-3-7/16	64620
3-1/2	MBP-3-1/2	64621

STANDARD TOLERANCES

DIMENSIONS	TOLERANCE
Bore	1-7/16-1-3/4 1-15/16-3-1/2
K	All

ALL DIMENSIONS IN INCHES

Bore	A	B	D	E	F Bolt	G	H	J	K	L	M	N	P	R* Setscrew UNF	S	Approx. Weight (Lbs.)
1-7/16	4-1/4	3-3/32	1-5/16	1-17/32	7/16	13/32	7/8	4	3-5/8	3/4	7/16	2-1/4	1-27/32	5/16-24	1-9/64	5.5
1-1/2	4-1/4	3-3/32	1-11/32	1-9/16	7/16	3/8	29/32	4	3-5/8	3/4	7/16	2-9/32	2-3/32	5/16-24	1-3/16	6.0
1-11/16 1-3/4	4-15/16	3-5/8	1-3/8	1-11/16	1/2	11/32	15/16	4-1/2	4-1/4	3/4	7/16	2-9/16	2-17/64	5/16-24	1-9/32	6.8
1-15/16 2	5-3/16	3-13/16	1-3/8	1-21/32	1/2	17/32	15/16	4-3/4	4-1/2	7/8	7/16	2-3/4	2-23/32	5/16-24	1-5/16	10.5
2-3/16 2-1/4	5-13/16	4-1/4	1-15/32	1-7/8	1/2	11/16	31/32	5-3/8	5	1	1/2	3-1/16	3-1/32	3/8-24	1-9/16	12.1
2-7/16 2-1/2	6-1/4	4-19/32	1-5/8	2-1/8	1/2	13/16	1-1/8	5-3/4	5-1/2	1-3/16	1/2	3-9/32	3-27/64	3/8-24	1-3/4	16.4
2-11/16	7-1/8	5-5/16	1-21/32	2-5/32	5/8	29/32	1-5/32	6-9/16	6-3/8	1-5/16	1/2	3-11/32	3-43/64	3/8-24	1-3/4	20.6
2-15/16 3	7-1/8	5-5/16	1-7/8	2-3/8	5/8	7/8	1-1/4	6-9/16	6-3/8	1-5/6	5/8	3-23/32	3-7/8	1/2-20	1-15/16	21.4
3-7/16 3-1/2	8-3/8	6-3/32	1-31/32	2-21/32	3/4	1-1/8	1-11/32	7-3/4	7-3/8	1-9/16	5/8	4-5/16	4-25/64	1/2-20	2-7/32	30.0

*2 AT 120°

For Load Ratings, See Engineering Section, Page 243.
Replacement Bearings are shown on Page 214.

Mounted Ball Bearings

A Series

Adjustable Shaft Supports – Standard Duty; Eccentric Locking Collar

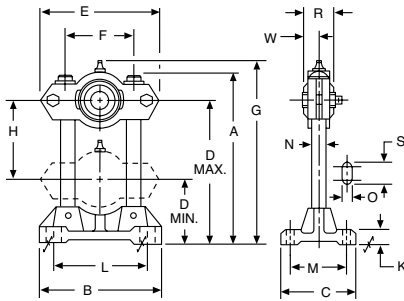

Features —

- Rigid one piece housing.
- Chrome alloy steel balls.
- Spherical outer race.
- Synthetic lip type seals.
- Eccentric locking collar.
- 1/4-28 threaded grease fitting.



ORDER BY CATALOG NUMBER OR ITEM CODE

Bore	Catalog Number	Item Code
1/2	3A-1/2	07008
5/8	3A-5/8	07010
3/4	4A-3/4	07012
7/8	5A-7/8	07016
15/16	5A-15/16	07018
1	5A-1	07020
1-1/8	6A-1-1/8	07024
1-3/16	6A-1-3/16	07026
1-1/4S	6A-1-1/4S	07028

STANDARD TOLERANCES

DIMENSIONS		TOLERANCE
Bore	All	+0.001 to -0.000

ALL DIMENSIONS IN INCHES

Bore	A	B	C	D		E	F	G Max.	H	
				Min.	Max.				Min.	Max.
1/2 5/8	7-1/8	5-1/8	3-1/8	2-13/32	6-1/16	4-7/8	2-3/4	7-7/16	2-1/2	3-21/32
3/4	7-1/8	5-1/8	3-1/8	2-17/32	6-1/16	4-7/8	2-3/4	7-9/16	2-13/16	3-17.32'
7/8 15/16 1	8-1/4	6-1/4	3-3/4	2-25/32	7-1/16	5-11/16	3-1/8	8-11/16	3	4-9/32
1-1/8 1-3/16 1-1/4S	11-1/4	8-1/8	4-1/2	3-1/2	9-15/16	7-11/16	4-3/8	11-25/32	3-7/16	6-7/16

Bore	K	L	M	N	O	R	S	W	Bolt Size
1/2 5/8	5/8	3-15/16	2-1/4	5/8	3/8	1-9/16	11/16	15/16	5/16
3/4	5/8	3-15/16	2-1/4	5/8	3/8	1-23/32	11/16	1-3/64	5/16
7/8 15/16 1	3/4	4-13/16	2-3/4	3/4	1/2	1-3/4	15/16	1-1/16	7/16
1-1/8 1-3/16 1-1/4S	1	6-3/8	3-1/4	1-1/4	5/8	2-5/16	1-1/8	1-3/16	9/16

NOTE: For applications where direction of radial bearing load is away from base, it is recommended that a hole be drilled near the end of each post and a suitable size pin inserted, as a safety precaution.

Replacement Bearings are shown on Page 213.

Mounted Bearings

TU Series Take-Up Frames

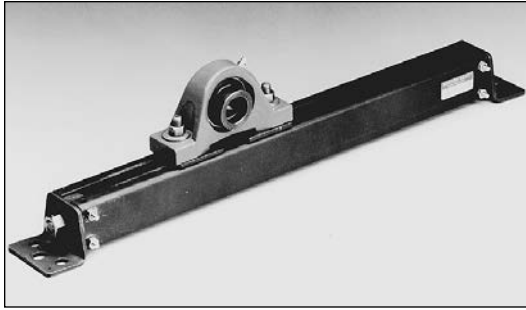

Boston Gear Take-up Frames are designed for use with Boston's Standard Duty Pillow Blocks. Pillow Block units are not included.

Features —

- Bolted steel frame
- 3 or 4 bolt frame mounting
- Bolt hole centers adjustable

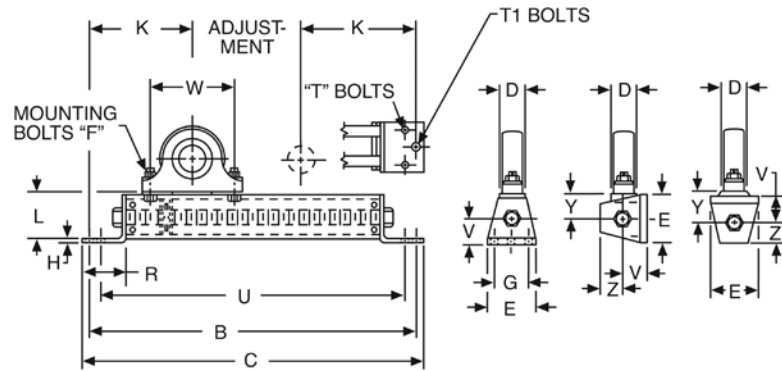

ALL DIMENSIONS IN INCHES

Pillow Block Bore	Adjustment	B	C	D	E	F Bolts	G	H	K	L	R
1/2-1	6	16	17	1-3/4	2-5/8	3/8	1-5/8	3/16	5	2-1/8	1-3/4
	9	19	20								
	12	22	23								
1-1/8-1-3/4	6	19-1/8	20-1/4	2-3/8	3-1/8	1/2	2-1/8	1/4	6-9/16	2-11/16	2-3/16
	9	22-1/8	23-1/4								
	12	25-1/8	26-1/4								
	18	31-1/8	32-1/4								
1-15/16-2-7/16	9	25-5/16	26-9/16	3	4	5/8	2-3/4	5/16	8-5/32	3-5/16	2-3/4
	12	28-5/16	29-9/16								
	18	34-5/16	35-9/16								
	24	40-5/16	41-9/16								

ORDER BY CATALOG NUMBER OR ITEM CODE

Pillow Block Bore	Adjustment	Bolts		U	V	W		Y	Z	Catalog Number	Item Code
		T	T1			Min.	Max.				
1/2-1	6	5/16	3/8	15-1/4	1-1/16	3	5	1-1/16	15/16	TU816-6	29827
	9			18-1/4						TU816-9	29828
	12			21-1/4						TU816-12	29829
1-1/8-1-3/4	6	3/8	1/2	18-1/8	1-11/32	3-3/4	7-1/4	1-11/32	1-3/32	TU1828-6	29830
	9			21-1/8						TU1828-9	29831
	12			24-1/8						TU1828-12	19832
	18			30-1/8						TU1828-18	29833
	24										
1-15/16-2-7/16	9	1/2	5/8	24-1/16	1-5/8	4-1/4	9	1-11/16	1-13/16	TU3139-9	29834
	12			27-1/16						TU3139-12	29835
	18			33-1/16						TU3139-18	29836
	24			39-1/16						TU3139-24	29837

Stainless Mounted Bearings

Pillow Blocks – Setscrew Locking 2 Bolt Pillow Block – Setscrew Locking; Extended Inner Race

Features —

Synthetic lip seal with stainless steel flinger provides superior protection for high pressure washdown conditions.

Pre-filled with NSF H1 food grade grease.

Cast stainless steel housing.

Laser marked.

M6 grease fitting.

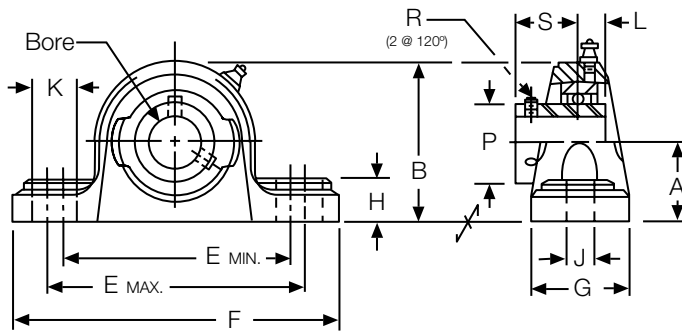
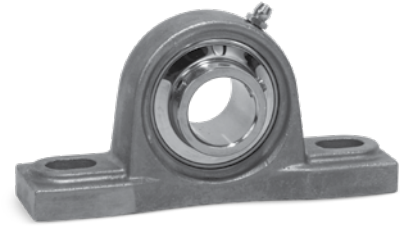

Stainless Steel Material	
AISI 304	AISI 440
Housing, cage, shield, setscrew, seal	Balls, inner/outer ring

ALL DIMENSIONS IN INCHES

Catalog Number	Bore Size	Dimensions (in)														Load Rating* (lbf)	
		A	B	E _{max}	E _{min}	F	G	H	J	K	L	P	R (UNF)	S	Bolt Size	CR	Co
SSUP4-3/4	3/4	1-5/16	2-9/16	4-1/8	3-3/8	5	1-1/2	9/16	1/2	3/4	0.500	1.142	1/4-28	0.721	3/8	2,901	1,507
SSUP5-1	1	1-7/16	2-25/32	4-1/2	3-3/4	5-1/2	1-1/2	19/32	1/2	3/4	0.563	1.339	1/4-28	0.780	3/8	3,175	1,782
SSUP6-1-3/16	1-3/16	1-11/16	3-1/4	5-1/32	4-15/32	6-1/2	1-7/8	21/32	43/64	25/32	0.626	1.591	1/4-28	0.874	1/2	4,431	2,558
SSUP7-1-1/4	1-1/4	1-7/8	3-21/32	5-9/32	4-23/32	6-9/16	1-7/8	45/64	43/64	25/32	0.689	1.866	5/16-24	1.000	1/2	5,847	3,472
SSUP7-1-7/16	1-7/16	1-7/8	3-21/32	5-9/32	4-23/32	6-9/16	1-7/8	45/64	43/64	25/32	0.689	1.866	5/16-24	1.000	1/2	5,847	3,472
SSUP8-1-1/2	1-1/2	1-15/16	3-15/16	5-11/16	5-1/8	7-1/4	2-1/8	45/64	43/64	25/32	0.748	2.075	5/16-24	1.189	1/2	6,632	4,069
SSUP10-1-15/16	1-15/16	2-1/4	4-29/64	6-17/32	5-31/32	8-1/8	2-3/8	53/64	25/32	29/32	0.748	2.465	3/8-24	1.284	5/8	7,868	5,216

ORDER BY CATALOG NUMBER OR ITEM CODE

Bore Size	Mounted Bearing		Bearing Insert	
	Catalog Number	Item Code	Catalog Number	Item Code
3/4	SSUP4-3/4	G01140	SSUC204-12	G01171
1	SSUP5-1	G01141	SSUC205-16	G01172
1-3/16	SSUP6-1-3/16	G01142	SSUC206-19	G01173
1-1/4	SSUP7-1-1/4	G01143	SSUC207-20	G01174
1-7/16	SSUP7-1-7/16	G01144	SSUC207-23	G01175
1-1/2	SSUP8-1-1/2	G05900	SSUC208-24	G05922
1-15/16	SSUP10-1-15/16	G05901	SSUC210-31	G05923

NOTES: Bore tolerance: +.001"/-.000".

Recommended shaft tolerance: Nominal +.000"/-.001".

Max recommended speed is 5000 RPM.

*CR=dynamic load rating, Co=static load rating.

Stainless Mounted Bearings

Pillow Blocks – Eccentric Locking Collar

2 Bolt Pillow Block – Eccentric Locking Collar; For Superior Shaft Holding Power

F

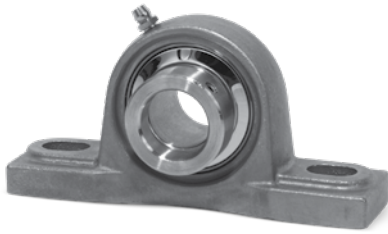

Features —

Synthetic lip seal with stainless steel flinger provides superior protection for high pressure washdown conditions.

Pre-filled with NSF H1 food grade grease.

Cast stainless steel housing.

Laser marked.

M6 grease fitting.

Stainless Steel Material	
AISI 304	AISI 440
Housing, cage, shield, setscrew, seal, collar	Balls, inner/outer ring

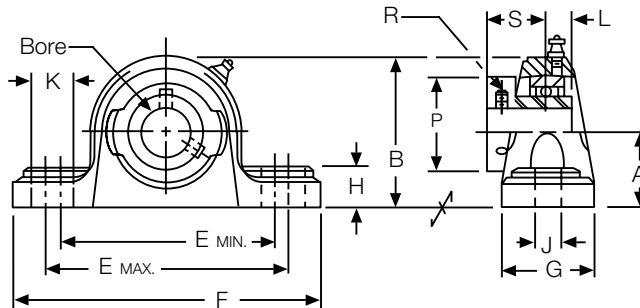

ALL DIMENSIONS IN INCHES

Catalog Number	Bore Size	Dimensions (in)														Load Rating* (lbf)	
		A	B	E _{max}	E _{min}	F	G	H	J	K	L	P	R (UNF)	S	Bolt Size	CR	CO
SSHP4-3/4	3/4	1-5/16	2-9/16	4-1/8	3-3/8	5	1-1/2	9/16	1/2	3/4	0.673	1.311	1/4-28	1.047	3/8	2,901	1,507
SSHP5-1	1	1-7/16	2-25/32	4-1/2	3-3/4	5-1/2	1-1/2	19/32	1/2	3/4	0.689	1.500	1/4-28	1.059	3/8	3,175	1,782
SSHP6-1-3/16	1-3/16	1-11/16	3-1/4	5-1/32	4-15/32	6-1/2	1-7/8	21/32	43/64	25/32	0.720	1.713	1/4-28	1.186	1/2	4,431	2,558
SSHP7-1-1/4	1-1/4	1-7/8	3-21/32	5-9/32	4-23/32	6-9/16	1-7/8	45/64	43/64	25/32	0.740	2.087	5/16-24	1.272	1/2	5,847	3,472
SSHP7-1-7/16	1-7/16	1-7/8	3-21/32	5-9/32	4-23/32	6-9/16	1-7/8	45/64	43/64	25/32	0.740	2.087	5/16-24	1.272	1/2	5,847	3,472
SSHP8-1-1/2	1-1/2	1-15/16	3-15/16	5-11/16	5-1/8	7-1/4	2-1/8	45/64	43/64	25/32	0.748	2.283	5/16-24	1.378	1/2	6,632	4,069
SSHP10-1-15/16	1-15/16	2-1/4	4-29/64	6-17/32	5-31/32	8-1/8	2-3/8	53/64	25/32	29/32	0.969	2.697	3/8-24	1.500	5/8	7,868	5,216

ORDER BY CATALOG NUMBER OR ITEM CODE

Bore Size	Mounted Bearing		Bearing Insert	
	Catalog Number	Item Code	Catalog Number	Item Code
3/4	SSHP4-3/4	G01145	SSHC204-12	G01176
1	SSHP5-1	G01146	SSHC205-16	G01177
1-3/16	SSHP6-1-3/16	G01147	SSHC206-19	G01178
1-1/4	SSHP7-1-1/4	G01148	SSHC207-20	G01179
1-7/16	SSHP7-1-7/16	G01149	SSHC207-23	G01180
1-1/2	SSHP8-1-1/2	G05902	SSHC208-24	G05924
1-15/16	SSHP10-1-15/16	G05903	SSHC210-31	G05925

NOTES: Bore tolerance: +.001"/-.000".

Recommended shaft tolerance: Nominal +.000"/-.001".

Max recommended speed is 5000 RPM.

*CR=dynamic load rating, CO=static load rating.

Stainless Mounted Bearings

Flanged Units – Setscrew Locking 2 Bolt Flange – Setscrew Locking; Extended Inner Race

Features —

Synthetic lip seal with stainless steel finger provides superior protection for high pressure washdown conditions.

Pre-filled with NSF H1 food grade grease.

Cast stainless steel housing.

Laser marked.

M6 grease fitting.

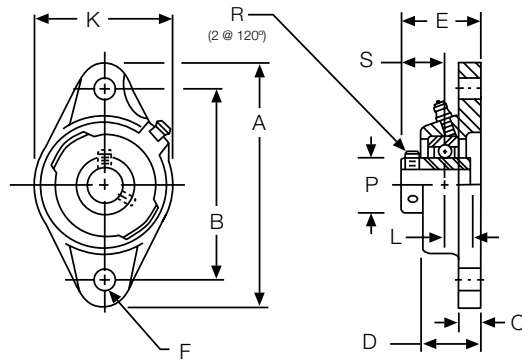

Stainless Steel Material	
AISI 304	AISI 440
Flange, cage, shield, setscrew, seal	Balls, inner/outer ring

ALL DIMENSIONS IN INCHES

Catalog Number	Bore Size	Dimensions (in)											Load Rating* (lbf)	
		A	B	C	D	E	Bolt Size F**	K	L	P	R (UNF)	S	CR	CO
SSUFL4-3/4	3/4	4-7/16	3-35/64	7/16	1.000	1-5/16	3/8	2-3/8	0.500	1.142	1/4-28	0.721	2,901	1,507
SSUFL5-1	1	5-1/8	3-57/64	1/2	1.063	1-13/32	1/2	2-11/16	0.563	1.339	1/4-28	0.780	3,175	1,782
SSUFL6-1-3/16	1-3/16	5-13/16	4-39/64	1/2	1.219	1-19/32	1/2	3-5/32	0.626	1.591	1/4-28	0.874	4,431	2,558
SSUFL7-1-1/4	1-1/4	6-11/32	5-1/8	35/64	1.344	1-3/4	1/2	3-35/64	0.689	1.866	5/16-24	1.000	5,847	3,472
SSUFL7-1-7/16	1-7/16	6-11/32	5-1/8	35/64	1.344	1-3/4	1/2	3-35/64	0.689	1.866	5/16-24	1.000	5,847	3,472
SSUFL8-1-1/2	1-1/2	6-7/8	5-43/64	35/64	1.422	2-1/64	1/2	3-15/16	0.748	2.075	5/16-24	1.189	6,632	4,069
SSUFL10-1-15/16	1-15/16	7-3/4	6-3/16	19/32	1.578	2-5/32	5/8	4-17/32	0.748	2.465	3/8-24	1.284	7,868	5,216

ORDER BY CATALOG NUMBER OR ITEM CODE

Bore Size	Mounted Bearing		Bearing Insert	
	Catalog Number	Item Code	Catalog Number	Item Code
3/4	SSUFL4-3/4	G01150	SSUC204-12	G01171
1	SSUFL5-1	G01151	SSUC205-16	G01172
1-3/16	SSUFL6-1-3/16	G01152	SSUC206-19	G01173
1-1/4	SSUFL7-1-1/4	G01153	SSUC207-20	G01174
1-7/16	SSUFL7-1-7/16	G01154	SSUC207-23	G01175
1-1/2	SSUFL8-1-1/2	G05904	SSUC208-24	G05922
1-15/16	SSUFL10-1-15/16	G05905	SSUC210-31	G05923

NOTES: Bore tolerance: +.001"/-.000".

Recommended shaft tolerance: Nominal +.000"/-.001".

Max recommended speed is 5000 RPM.

*CR=dynamic load rating, CO=static load rating.

** Smaller bolt sizes are acceptable with the use of flat washers

Stainless Mounted Bearings

Flanged Units – Setscrew Locking

4 Bolt Flange – Setscrew Locking; Extended Inner Race

F



Features —

Synthetic lip seal with stainless steel flinger provides superior protection for high pressure washdown conditions.

Pre-filled with NSF H1 food grade grease.

Cast stainless steel housing.

Laser marked.

M6 grease fitting.

Stainless Steel Material	
AISI 304	AISI 440
Flange, cage, shield, setscrew, seal	Balls, inner/outer ring

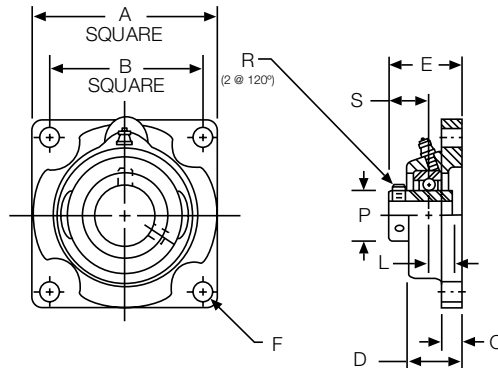

ALL DIMENSIONS IN INCHES

Catalog Number	Bore Size	Dimensions (in)										Load Rating* (lbf)	
		A	B	C	D	E	Bolt Size F**	L	P	R (UNF)	S	CR	Co
SSUF4-3/4	3/4	3-3/8	2-33/64	15/32	1.000	1-5/16	3/8	0.500	1.142	1/4-28	0.721	2,901	1,507
SSUF5-1	1	3-3/4	2-3/4	35/64	1.063	1-13/32	3/8	0.563	1.339	1/4-28	0.780	3,175	1,782
SSUF6-1-3/16	1-3/16	4-1/4	3-17/64	35/64	1.219	1-19/32	3/8	0.626	1.591	1/4-28	0.874	4,431	2,558
SSUF7-1-1/4	1-1/4	4-39/64	3-5/8	5/8	1.344	1-3/4	7/16	0.689	1.866	5/16-24	1.000	5,847	3,472
SSUF7-1-7/16	1-7/16	4-39/64	3-5/8	5/8	1.344	1-3/4	7/16	0.689	1.866	5/16-24	1.000	5,847	3,472
SSUF8-1-1/2	1-1/2	5-1/8	4-1/64	5/8	1.422	2-1/64	1/2	0.748	2.075	5/16-24	1.189	6,632	4,069
SSUF10-1-15/16	1-15/16	5-13/32	4-3/8	23/32	1.578	2-5/32	1/2	0.748	2.465	3/8-24	1.284	7,868	5,216

ORDER BY CATALOG NUMBER OR ITEM CODE

Bore Size	Mounted Bearing		Bearing Insert	
	Catalog Number	Item Code	Catalog Number	Item Code
3/4	SSUF4-3/4	G01155	SSUC204-12	G01171
1	SSUF5-1	G01156	SSUC205-16	G01172
1-3/16	SSUF6-1-3/16	G01157	SSUC206-19	G01173
1-1/4	SSUF7-1-1/4	G01158	SSUC207-20	G01174
1-7/16	SSUF7-1-7/16	G01159	SSUC207-23	G01175
1-1/2	SSUF8-1-1/2	G05906	SSUC208-24	G05922
1-15/16	SSUF10-1-15/16	G05907	SSUC210-31	G05923

NOTES: Bore tolerance: +.001"/-.000".

Recommended shaft tolerance: Nominal +.000"/-.001".

Max recommended speed is 5000 RPM.

*CR=dynamic load rating, Co=static load rating.

** Smaller bolt sizes are acceptable with the use of flat washers

Stainless Mounted Bearings

Flanged Units – Setscrew Locking 3 Bolt Flange – Setscrew Locking; Extended Inner Race

Features —

Synthetic lip seal with stainless steel flinger provides superior protection for high pressure washdown conditions.

Pre-filled with NSF H1 food grade grease.

Cast stainless steel housing.

Laser marked.

M6 grease fitting.



F

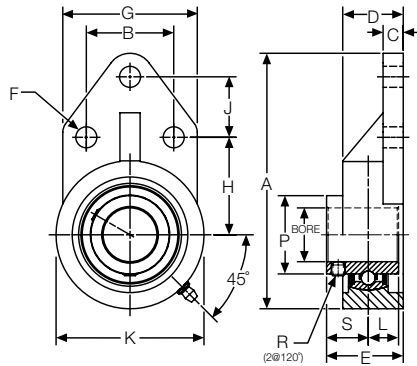

Stainless Steel Material	
AISI 304	AISI 440
Flange, cage, shield, setscrew, seal	Balls, inner/outer ring

ALL DIMENSIONS IN INCHES

Catalog Number	Bore Size	Dimensions (in)														Load Rating* (lbf)	
		A	B	C	D	E	Bolt Size F**	G	H	J	K	L	P	R (UNF)	S	CR	Co
SSUFB4-3/4	3/4	4-1/4	1-1/2	5/16	1	1.35	5/16	2-3/8	1-11/16	7/8	2-1/2	0.500	1.142	1/4-28	0.850	2,901	1,507
SSUFB5-1	1	4-3/4	1-5/8	3/8	1-5/64	1.43	5/16	2-1/2	1-13/16	1-1/8	2-3/4	0.563	1.339	1/4-28	0.867	3,175	1,782
SSUFB6-1-3/16	1-3/16	5-3/8	1-7/8	3/8	1-7/64	1-19/32	5/16	2-3/4	2-1/16	1-1/4	3-1/4	0.626	1.591	1/4-28	0.968	4,431	2,558
SSUFB7-1-1/4	1-1/4	6-1/8	2	1/2	1-1/4	1-3/4	7/16	3-1/4	2-3/8	1-1/4	3-3/4	0.689	1.866	5/16-24	1.061	5,847	3,472
SSUFB7-1-7/16	1-7/16	6-1/8	2	1/2	1-1/4	1-3/4	7/16	3-1/4	2-3/8	1-1/4	3-3/4	0.689	1.866	5/16-24	1.061	5,847	3,472
SSUFB8-1-1/2	1-1/2	6-15/32	1-31/32	5/8	1-13/32	2-1/64	3/8	3-1/16	2-3/8	1-5/8	3-15/16	0.748	2.075	5/16-24	1.267	6,632	4,069
SSUFB10-1-15/16	1-15/16	7-1/2	2-3/4	1/2	1-1/2	2-5/32	7/16	4	2-15/16	1-5/8	4-5/8	0.748	2.465	3/8-24	1.408	7,868	5,216

ORDER BY CATALOG NUMBER OR ITEM CODE

Bore Size	Mounted Bearing		Bearing Insert	
	Catalog Number	Item Code	Catalog Number	Item Code
3/4	SSUFB4-3/4	G05908	SSUC204-12	G01171
1	SSUFB5-1	G05909	SSUC205-16	G01172
1-3/16	SSUFB6-1-3/16	G05910	SSUC206-19	G01173
1-1/4	SSUFB7-1-1/4	G05911	SSUC207-20	G01174
1-7/16	SSUFB7-1-7/16	G05912	SSUC207-23	G01175
1-1/2	SSUFB8-1-1/2	G05913	SSUC208-24	G05922
1-15/16	SSUFB10-1-15/16	G05914	SSUC210-31	G05923

NOTES: Bore tolerance: +.001"/-.000".

Recommended shaft tolerance: Nominal +.000"/-.001".

Max recommended speed is 5000 RPM.

*CR=dynamic load rating, Co=static load rating.

** Smaller bolt sizes are acceptable with the use of flat washers

Stainless Mounted Bearings

Take Up Units – Setscrew Locking

Wide Slot Take Up Unit – Setscrew Locking; Extended Inner Race

F



Features —

Synthetic lip seal with stainless steel finger provides superior protection for high pressure washdown conditions.

Pre-filled with NSF H1 food grade grease.

Cast stainless steel housing.

Laser marked.

M6 grease fitting.

Stainless Steel Material	
AISI 304	AISI 440
Flange, cage, shield, setscrew, seal	Balls, inner/outer ring

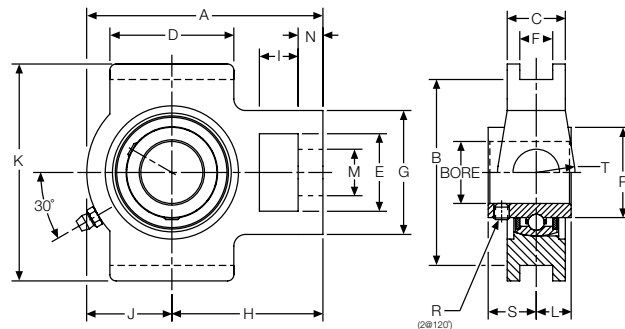

ALL DIMENSIONS IN INCHES

Catalog Number	Bore Size	Dimensions (in)																Load Rating* (lb)		
		A	B	C	D	E	F	G	H	I	J	K	L	M	N	P	R (UNF)	S	CR	CO
SSUT4-3/4	3/4	3-11/16	2-63/64	13/16	2-1/64	1.250	0.469	2-1/64	2-13/32	0.625	1-9/32	3-1/2	0.500	0.750	0.391	1.142	1/4-28	0.721	2,901	1,507
SSUT5-1	1	3-13/16	2-63/64	15/16	2-1/64	1.250	0.469	2-1/64	2-7/16	0.625	1-3/8	3-1/2	0.563	0.750	0.391	1.339	1/4-28	0.780	3,175	1,782
SSUT6-1-3/16	1-3/16	4-29/64	3-1/2	1-3/32	2-1/4	1.453	0.469	2-7/32	2-3/4	0.625	1-45/64	4-1/64	0.626	0.859	0.391	1.591	1/4-28	0.874	4,431	2,558
SSUT7-1-1/4	1-1/4	5-5/64	3-1/2	1-3/16	2-33/64	1.453	0.469	2-33/64	3-5/64	0.625	2	4-1/64	0.689	0.859	0.516	1.866	5/16-24	1.000	5,847	3,472
SSUT7-1-7/16	1-7/16	5-5/64	3-1/2	1-3/16	2-33/64	1.453	0.469	2-33/64	3-5/64	0.625	2	4-1/64	0.689	0.859	0.516	1.866	5/16-24	1.000	5,847	3,472
SSUT8-1-1/2	1-1/2	5-43/64	4-1/64	1-5/16	3-17/64	1.938	0.625	3-17/64	3-1/2	0.750	2-11/64	4-31/64	0.748	1.141	0.625	2.075	5/16-24	1.189	6,632	4,069
SSUT10-1-15/16	1-15/16	5-55/64	4-1/64	1-15/32	3-17/64	1.938	0.625	3-17/64	3-35/64	0.750	2-5/16	4-39/64	0.748	1.141	0.625	2.465	3/8-24	1.284	7,868	5,216

ORDER BY CATALOG NUMBER OR ITEM CODE

Bore Size	Mounted Bearing		Bearing Insert	
	Catalog Number	Item Code	Catalog Number	Item Code
3/4	SSUT4-3/4	G05915	SSUC204-12	G01171
1	SSUT5-1	G05916	SSUC205-16	G01172
1-3/16	SSUT6-1-3/16	G05917	SSUC206-19	G01173
1-1/4	SSUT7-1-1/4	G05918	SSUC207-20	G01174
1-7/16	SSUT7-1-7/16	G05919	SSUC207-23	G01175
1-1/2	SSUT8-1-1/2	G05920	SSUC208-24	G05922
1-15/16	SSUT10-1-15/16	G05921	SSUC210-31	G05923

NOTES: Bore tolerance: +.001"/-.000".

Recommended shaft tolerance: Nominal +.000"/-.001".

Max recommended speed is 5000 RPM.

*CR=dynamic load rating, Co=static load rating.

Analysis of Radial Bearing Loads for Unmounted and Mounted Rolling Elements

Radial Load

Radial bearing loads are determined by analysis of all the forces applied to a shaft. In many instances this becomes a complex analysis and should be performed with expertise. However, many applications involve simple loading and may be calculated with basic information.

Many shafts are supported by two bearings, with a load “L” applied either between two bearings, as in Figure 1; or with load overhung, as in Figure 2. In either case, the reaction on the bearing is dependent upon:

- a. The point of load application
- b. The magnitude of the load.
- c. The distance between the bearing centers.

With the above information known, the reactions, due to the loads, on the bearings, may be calculated.

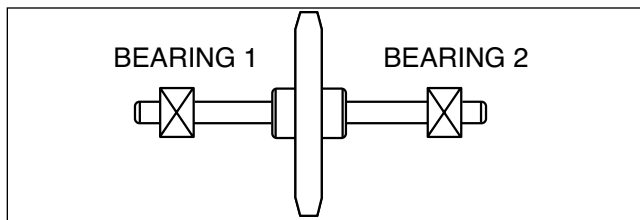

FIGURE 1.

When the applied load is located between the two bearings, it is commonly referred to as “Straddle” loading.

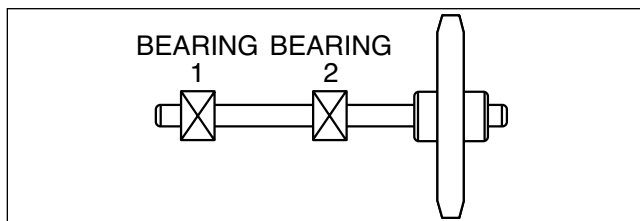

FIGURE 2.

When the applied load is located outside the two bearings, it is commonly referred to as “Overhung” loading.

The loading of a shaft usually is the result of forces generated by gearing, sprockets or pulleys, the weight of these parts and friction.

Normally the weight of the parts and friction are ignored. However, if the weight of these parts is large, they should be considered.

In this text we are mainly considering radial loading of the shaft. Each load should be calculated individually as the sum of these will be used to calculate the load imposed on the bearings.

Load Connection Factor

Loads applied by various types of drives may be calculated with use of the following load connection factors and formula:

$$L = \frac{2TK}{D}$$

L = Load (Lbs.)

$$T = \text{Torque (Lb-Ins.)} \quad T = \frac{(63025)(\text{H.P.})}{\text{RPM}}$$

K = Load Connection Factor

D = P.D. of Sprocket, Pinion, or Pulley (In.)

Load Connection Factors (K)

Sprocket or Timing Belt	1.00
Pinion and Gear Drive	1.25
Pulley and V-Belt Drive	1.50
Pulley and Flat-Belt Drive.....	2.50

Example “A”

Load smooth and steady 8 hours per day.

- #40 Chain Drive
- 30 Tooth Sprocket
- 4.783 Sprocket P.D.
- 2 HP
- 500 RPM
- 5/8 Shaft Dia.

With the above information the load can be calculated as follows:

$$L = \frac{2TK}{D}$$

$$T = \frac{63025 \times 2}{\text{RPM}} = 252 \text{ In. Lbs.}$$

K = 1.0 From Load Connection Factor Table

D = 4.783

$$L = \frac{2 \times 252 \times 1.0}{4.783}$$

L = 105 lbs. Radial Load

Engineering Information

Analysis of Radial Bearing Loads for Unmounted and Mounted Rolling Elements (Cont'd)

F

Magnitude of Load Acting on Bearings

Once the applied load or loads that act on the shaft is determined, we may now apply it to the bearings.

There are many types of loadings that can be imposed on a bearing:

Straddle Loaded Bearings

Radial Applied Load Acting On Shaft

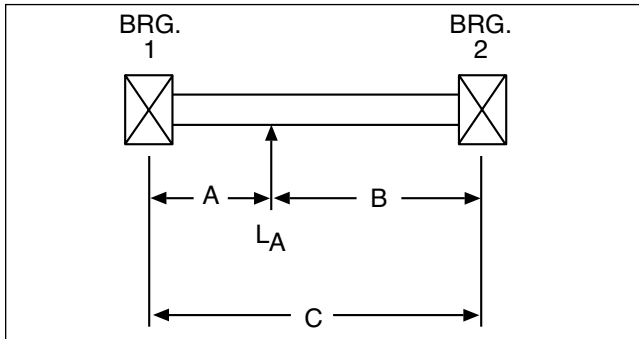

$$\text{Load Bearing I} = L_I = \frac{L_A \times B}{C}$$

$$\text{Load Bearing II} = L_{II} = \frac{L_A \times A}{C}$$

$$\text{Check } L_I + L_{II} = L_A$$

Overhung Loaded Bearings

Radial Applied Load Acting On Shaft

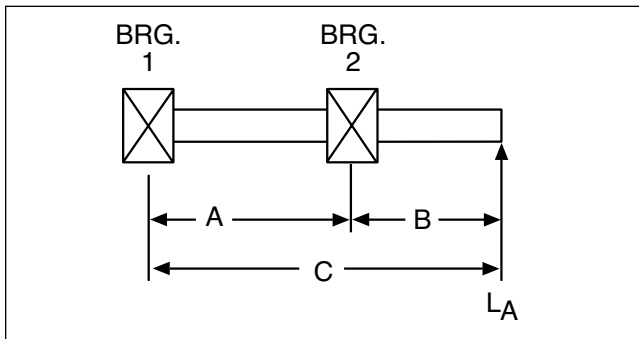

$$\text{Load Bearing I} = L_I = \frac{L_A \times B}{A}$$

$$\text{Load Bearing II} = L_{II} = \frac{L_A \times C}{A}$$

$$\text{Check } L_{II} - L_I = L_A$$

Example "B"

Load given in Example "A" = 105 lbs. is in overhung condition, as shown.

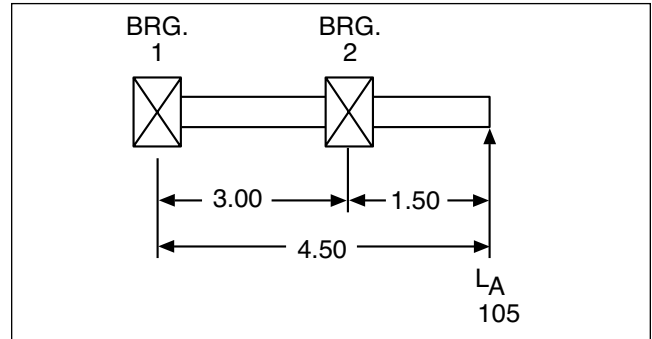

LOAD BEARING I

$$L_I = \frac{L_A \times B}{A}$$

$$L_I = \frac{105 \times 1.50}{3.00}$$

$$L_I = 52.5 \text{ lbs.}$$

LOAD BEARING II

$$L_{II} = \frac{L_A \times C}{A}$$

$$L_{II} = \frac{105 \times 4.5}{3.0}$$

$$L_{II} = 157.5 \text{ lbs.}$$

CHECK

$$L_{II} - L_I = L_A$$

$$157.5 - 52.5 = 105$$

$$105 = 105$$

Ball and Mounted Ball Bearing Selection

Bearing selection for the majority of applications can be made directly from the Load Rating Tables. Mounted bearings are listed individually on each page. The mounted bearings tables are located on Pages 108-109.

The following procedure may be followed:

1. Determine the actual radial load to be supported by the bearing. For applications involving heavy shock loads or severe vibration, actual load should be multiplied by a service factor from 1.1 to 1.5 depending on the severity of these conditions.

2. Select a bearing from the table that has a radial load rating equal to or greater than the actual radial load determined in Step 1, for the life desired at the required operating speed.

Ball bearing rating tables are based on an “Average” bearing life of 2500 hours. Average or medium life (L_{50}) is the life that may be expected from 50% or more of a given group of bearings operating under an identical steady load condition. The minimum life (L_{10}) is the life expectancy of at least 90% of a group of bearings and is approximately 1/5 average.

Service Factor	Operating Conditions
.8	Uniform — not more than 15 minutes in 2 hours.
1.0	Moderate Shock — not more than 15 minutes in 2 hours. Uniform — not more than 10 hours per day
1.25	Moderate Shock — not more than 10 hours per day. Uniform — more than 10 hours per day.
1.50	Heavy Shock — not more than 15 minutes in 2 hours. Moderate Shock — more than 10 hours per day.
1.75	Heavy Shock — not more than 10 hours per day.
2.0	Heavy Shock — more than 10 hours per day.

Example “C”

Using loading from Example “B,” select a mounted bearing suitable to give an average life (L_{50}) of 15,000 hours.

Known—

Load Bearing I = 52.5

Load Bearing II = 157.5

Shaft Diameter 5/8 (From Example “A”)

Service Factor 1 (From Example “A”)

500 RPM (From Example “A”)

From the Rating Table, Page 243, as shown, a standard duty bearing (either eccentric collar or extended set screw inner race) may be selected.

Engineering Information

Mounted Ball Bearing Radial Load Capacities Light Duty PS Series Pillow Blocks

F

Shaft Sizes	Average Life (L ₅₀) Hours	Speed (R.P.M.)							
		Radial Load (Pounds)							
		50	100	500	1000	1500	1800	2000	2500
1/2 5/8	2,500	300	300	300	300	300	300	300	300
	5,000	300	300	300	300	300	300	300	300
	7,500	300	300	300	245	215	200	195	180
	15,000	300	300	280	220	195	180	175	165
	75,000	300	300	245	195	170	160	155	140
3/4	2,500	350	350	350	350	350	350	350	350
	5,000	350	350	350	350	350	350	350	350
	7,500	350	350	350	330	285	270	260	240
	15,000	350	350	350	300	260	245	235	220
	75,000	350	350	350	260	225	215	205	190
7/8 15/16 1	2,500	400	400	400	400	400	400	400	400
	5,000	400	400	400	400	400	400	400	400
	7,500	400	400	400	360	315	295	285	265
	15,000	400	400	400	325	285	270	260	240
	75,000	400	400	360	285	250	235	225	210
1-1/16 1-1/8 1-3/16 1-1/4	2,500	600	600	600	600	600	600	600	600
	5,000	600	600	600	600	600	600	600	600
	7,500	600	600	600	500	435	410	395	370
	15,000	600	600	570	455	395	375	360	335
	75,000	600	600	500	395	345	325	315	295

PS2 and PS3 Series Flanged Units

Shaft Sizes	Average Life (L ₅₀) Hours	Speed (R.P.M.)							
		Radial Load (Pounds)							
		50	100	500	1000	1500	1800	2000	2500
1/2 5/8	2,500	600	600	600	530	460	435	420	390
	5,000	600	600	530	420	365	385	330	310
	7,500	600	530	310	245	215	200	195	180
	15,000	600	480	280	220	195	180	175	165
	75,000	530	420	245	195	170	160	155	140
3/4	2,500	700	700	700	700	620	585	560	520
	5,000	700	700	700	560	490	460	445	415
	7,500	700	700	415	330	285	270	260	240
	15,000	700	645	375	300	260	245	235	220
	75,000	700	560	330	260	225	215	205	190
7/8 15/16 1	2,500	800	800	800	775	680	640	615	570
	5,000	800	800	775	615	540	505	490	455
	7,500	800	775	455	360	315	295	285	265
	15,000	800	705	410	325	285	270	260	240
	75,000	775	615	360	285	250	235	225	210
1-1/16 1-1/8 1-3/16 1-1/4S	2,500	1100	1100	1100	1080	940	885	855	795
	5,000	1100	1100	1080	855	750	700	680	630
	7,500	1100	1080	630	500	435	410	395	370
	15,000	1100	980	570	455	395	375	360	335
	75,000	1080	855	500	395	345	325	315	295
1-1/4 1-5/16 1-3/8 1-7/16	2,500	1400	1400	1400	1400	1245	1175	1130	1050
	5,000	1400	1400	1400	1130	990	930	895	835
	7,500	1400	1400	835	660	580	545	525	485
	15,000	1400	1295	755	600	525	495	475	440
	75,000	1400	1130	660	525	460	430	415	385

Application Data – Unmounted Bearings

Lubrication

Either oil or grease can be used for lubricating bearings. Boston bearings are supplied slushed (open bearings) with a rust inhibiting oil, or prepacked with grease (sealed or shielded bearings) at the factory. However, special purpose lubricants can be used when required. It is recommended that bearing selection include consideration of the lubricant specifications and whether the lubricant will be applied in service or prepacked at the factory. Good lubrication adds measurably to the life of a bearing.

Precautions

1. Keep bearings clean and protected with covering until ready to install.
2. Make preliminary examination of shaft and housing for correct window size. Also check for chips, filings and burrs.
3. Press inner race on shaft or outer race in housing preferably by use of arbor press. Never transmit mounting press forces through balls from one race to the other.
4. Avoid hammer blows.

Recommended Shaft Fits — 1600-3000-7500-7600 Series

Bearing Bore		Shaft Rotating				Shaft Stationary			
		Shaft Diameter		Theoretical Fit		Shaft Diameter		Theoretical Fit	
Max.	Min.	Max.	Min.	Tight	Loose	Max.	Min.	Tight	Loose
.2500	.2495	.2500	.2495	.0005	.0005	.2495	.2490	.0000	.0010
.3125	.3120	.3125	.3120	.0005	.0005	.3120	.3115	.0000	.0010
.3750	.3745	.3750	.3745	.0005	.0005	.3745	.3740	.0000	.0010
.4375	.4370	.4375	.4370	.0005	.0005	.4370	.4365	.0000	.0010
.5000	.4995	.5000	.4995	.0005	.0005	.4995	.4990	.0000	.0010
.6250	.6245	.6250	.6245	.0005	.0005	.6245	.6240	.0000	.0010
.7500	.7495	.7500	.7495	.0005	.0005	.7495	.7490	.0000	.0010
.8750	.8745	.8752	.8747	.0007	.0003	.8745	.8740	.0000	.0010
1.0000	.9995	1.0002	.9997	.0007	.0003	.9995	.9990	.0000	.0010
1.1250	1.1245	1.1252	1.1247	.0007	.0003	1.1245	1.1240	.0000	.0010
1.2500	1.2405	1.2502	1.2497	.0007	.0003	1.2495	1.2490	.0000	.0010

Recommended Housing Fits — 1600-3000-7500-7600 Series

Bearing Outside Diameter		Housing Rotating				Housing Stationary			
		Housing Inside Diameter		Theoretical Fit		Housing Inside Diameter		Theoretical Fit	
Max.	Min.	Max.	Min.	Tight	Loose	Max.	Min.	Tight	Loose
.6875	.6870	.6877	.6870	.0005	.0007	.6880	.6875	.0000	.0010
.8750	.8745	.8752	.8745	.0005	.0007	.8755	.8750	.0000	.0010
.9063	.9058	.9065	.9058	.0005	.0007	.9068	.9063	.0000	.0010
1.1250	1.1245	1.1252	1.1242	.0008	.0007	1.1255	1.1250	.0000	.0010
1.3750	1.3745	1.3752	1.3742	.0008	.0007	1.3755	1.3750	.0000	.0010
1.6250	1.6245	1.6252	1.6242	.0008	.0007	1.6258	1.6250	.0000	.0013
1.7500	1.7495	1.7502	1.7492	.0008	.0007	1.7508	1.7500	.0000	.0013
2.0000	1.9994	2.0002	1.9990	.0010	.0008	2.0010	2.0000	.0000	.0016
2.5000	2.4994	2.5002	2.4990	.0010	.0008	2.5010	2.5000	.0000	.0016
2.5625	2.5619	2.5627	2.5615	.0010	.0008	2.5635	2.5625	.0000	.0016

Note: 3000 Series Dim Are Nom. +.0005
7600 Series Dim Are Nom. +.0008

Application Data – Mounted Bearings

Lubrication

Boston Gear ball and tapered roller bearing Pillow Blocks and Flanged Cartridges are factory lubricated prior to shipping. Those designed with the relubrication feature periodically require grease during operation. The interval between relubrication and the amount necessary to insure a long operational life are determined by the specific application.

Loading, speed, and environmental conditions must be considered when determining the proper interval between relubrication.

Hours Operated Per Day	Weeks							
	1-250 RPM	251-500 RPM	501-750 RPM	751-1000 RPM	1001-1500 RPM	1501-2000 RPM	2001-2500 RPM	2501-3000 RPM
8	12	12	10	7	5	4	3	2
16	12	7	5	4	2	2	1	1
24	10	5	3	2	1	1	1	1

The table above may be used as a guide for establishing lubrication intervals for applications where contamination is not present.

For unusual operating conditions not covered by the table, consult the factory for our recommendations. Normal bearing operation temperatures range from “cool-to-the-touch” to “too-hot-to-touch” for more than a few seconds, depending on the load, speed, and ambient temperature.

The type of grease used in Boston bearing units allows satisfactory operation at temperatures to 225°F and speeds to 6500 RPM.

Bearings are prelubricated with a No. 2 consistency lithium base grease, and it is recommended that the Lith EP-2 or an equivalent grease be used when relubrication is required. When relubricating bearings, it is preferable that the shaft be rotating. This rotation of the shaft will aid in preventing excessive filling and insure proper distribution of the grease.

Grease should be added slowly to the bearing. When a slight bead appears from under the seal, the bearing will usually contain the proper amount of lubricant.

Precautions

The shaft must be clean, straight and free from nicks and burns and should fit the bearing as snugly as possible. Recommended shaft tolerance – Low Speed (or Light Load) +.0 to -.002; Normal Speed (or Load) +.0 to -.001; High Speed (or Heavy Load) a light press fit is desirable.

The use of flats at setscrew locations will permit ease of shaft removal.

Mounting

Setscrew Locking Type

Housing should be fastened to the mounting structure. Back out setscrews to clear shaft. After lubricating the shaft, slide it through the bearings and tighten setscrews to recommended torque, see Table below.

Eccentric Locking Collar Type

When sliding the shaft through the bore bearing inner ring, be sure that the counterbore of eccentric collar “A” is toward eccentric boss “B” on inner ring.

Turn eccentric collar “A” in the direction in which the shaft will rotate. Hand tight is often sufficient but a spanner wrench or drift pin may be inserted in spanner wrench hole “C” and used to set the collar (Note: DO NOT USE A DIRECT HAMMER BLOW to set the collar as such a blow may fracture the inner ring.) Not recommended for severe reversing applications.

Tighten set screw in eccentric collar firmly against shaft to recommended torque, see Table below.

Set Screw Diameter	Hex Width Across Flats	Tightening Torque (In.-Lbs.)
1/4	1/8	70
5/16	5/32	140
3/8	5/16	220
7/16	7/32	350
1/2	1/4	515
5/8	5/16	1200



NOTE: PS, PS2 and PS3 series: It is particularly important on these units that shaft be in place before the housing is secured to the mounting structure. The self-aligning steel stampings clamp the outer race when bolts are tightened making further shaft alignment impossible.



Section Contents

ROLLER CHAINS

General Description	250
Ordering Information	251
Multi-Strand Selection Charts	252
Transmission Series	253
Conveyor Series	253
Heavy Series	253
Engineering	254-257
Roller Chain Attachments	259
Hollow Pin	260

BLOCK CHAINS

Selection Charts/Dimensions	261
-----------------------------------	-----

LEAF (CABLE) CHAINS

Selection Charts/Dimensions	261
-----------------------------------	-----

LADDER CHAINS

Selection Charts/Dimensions	262
-----------------------------------	-----

MINIATURE ROLLER CHAINS

Selection Charts	263
------------------------	-----

CHAIN PULLERS/CHAIN BREAKING TOOLS

Selection Charts	264
------------------------	-----

Roller Chains

Description of Roller Chain Parts

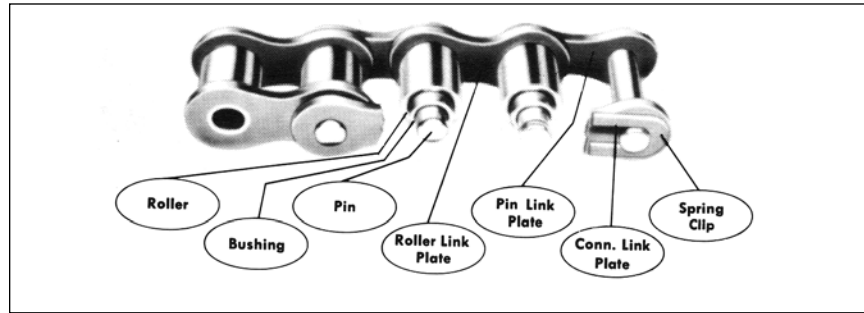

Chain Dimensions

Principal dimensions of roller chain which identify the chain definitely are pitch, roller width, roller diameter and pin diameter.

PITCH is the linear distance from center to center of adjacent pins or rivets.

WIDTH is the distance between inside plates or length of roller.

DIAMETER is the actual outside diameter of roller (or pin).

Chain Types

Boston Roller chains can be furnished in two types — RIVETED and DETACHABLE.

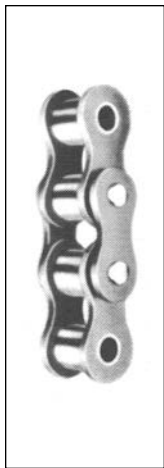

RIVETED TYPE

Riveted type chains are recommended for high speed drives, as a greater rigidity of the pins and side plates is secured from this construction.

Riveted type is considered standard on the smaller sizes up to and including 3/4" pitch and will be supplied unless Detachable type is specified. Detachable type chain is not recommended up to and including 5/8" pitch, but is available in cotter pin construction in 3/4" pitch.

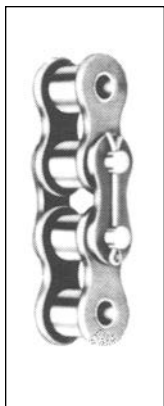

DETACHABLE (Cottered) TYPE

Detachable type chains are recommended for slower speed drives, especially in the larger pitches where ease of assembly and disassembly becomes an important factor.

Detachable type with cotter pins is considered standard on all sizes 1" pitch and above and will be supplied unless riveted type is specified. Both types are available.

Chain Links

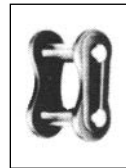

CONNECTING LINK (Spring Clip)

Standard for Nos. 25, 35, 40, 41, 50 and 60 single and multiple-width chains.

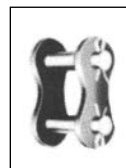

CONNECTING LINK (Cotter Pin)

Standard for Nos. 80, 100, 120, 140, and 160, 200 and 240 single and multiple-width chains.

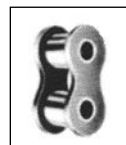

ROLLER LINK

Furnished as complete assemblies, roller links are standard for all chain sizes. The same roller links are used for single and multiple-width chains.

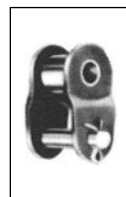

ONE PITCH OFFSET LINK (For standard service)

For use whenever chain length contains an odd number of pitches. These links are standard for all chain sizes in single or multiple-widths. (Not available for 25 pitch.)

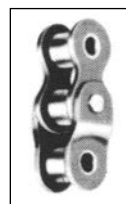

TWO PITCH OFFSET LINK (For severe service)

Consists of a roller link and an offset link riveted together. Two pitch offset assemblies should be specified for severe service.

Ordering Information

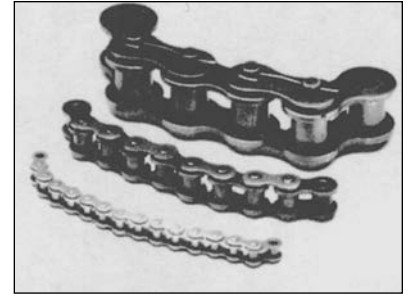
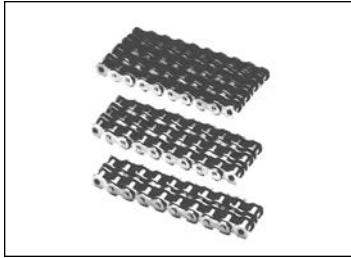

STEEL - SINGLE STRAND

Chain Pitch & Number	Standard Package Quantities	Catalog Number	Item Code
1/4" - 25*	10' PKG.	25 - 10'	68948
	100' REEL	25 100'	69010
	250' REEL	25 - 250'	68950
	500' REEL	25 - 500'	68951
3/8" - 35*	10' PKG.	35 - 10'	68953
	100' REEL	35 - 100'	68954
	250' REEL	35 - 250'	68955
	500' REEL	35 - 500'	68956
1/2" - 40	10' PKG	40 - 10'	68959
	100' REEL	40 - 100'	68960
	250' REEL	40 - 250'	68961
1/2" - 41	10' PKG	41 - 10'	68964
	100' REEL	41 - 100'	68965
	250' REEL	41 - 250'	68966
	500' REEL	41 - 500'	68967
1/2" - 43	10' PKG	43 - 10'	68947
5/8" - 50	10' PKG	50 - 10'	68984
	100' REEL	50 - 100'	68985
	250' REEL	50 - 250'	68986
3/4" - 60	10' PKG	60 RIV - 10'	68989
	100' REEL	60 RIV - 100'	68990
	10' PKG	60 DET - 10'	68991
1" - 80	10' PKG	80 RIV - 10'	68808
	50' REEL	80 RIV - 50'	29948
	10' PKG	80 DET - 10'	68812
1-1/4" - 100	10' PKG	100 RIV - 10'	68936
	10' PKG	100 DET - 10'	68937
1-1/2" - 120	10' PKG	120 RIV - 10'	68940
	10' PKG	120 DET - 10'	68941
1-3/4" - 140	10'2-1/2" PKG	140 RIV - 10'2-1/2"	30440
	10'2-1/2" PKG	140 DET - 10'2-1/2"	30438
2" - 160	10' PKG	160 RIV - 10'	30462
	10' PKG	160 DET - 10'	30460
2-1/4" - 180	10' PKG	180 RIV - 10'	50219
	10' PKG	180 DET - 10'	30478
2-1/2" - 200	10' PKG	200 RIV - 10'	31066
	10' PKG	200 DET - 10'	30488
3" - 240	5' PKG	240 RIV - 5'	50210
STEEL - DOUBLE STRAND			
1/4" - 25-2*	10' PKG	25-2-10'	45886
3/8" - 35-2"	10' PKG	35-2-10'	69011
1/2" - 40-2	10' PKG	40-2-10'	69014
5/8" - 50-2	10' PKG	50-2-10'	69017
3/4" - 60-2	10' PKG	60-2 RIV - 10'	69020
	10' PKG	60-2- DET - 10'	68935
1" - 80-2	10' PKG	80-2 RIV - 10'	68813
	10' PKG	80-2 DET - 10'	68816
1-1/4" - 100-2	10' PKG	100-2 RIV - 10'	68938
	10' PKG	100-2 DET - 10'	68939
1-1/2" - 120-2	10' PKG	120-2 RIV - 10'	68942
	10' PKG	120-2 DET - 10'	68943
1-3/4" - 140-2	10'2-1/2" PKG	140-2RIV-10'2-1/2"	06085
	10'2-1/2" PKG	140-2DET-10'2-1/2"	30448
2" - 160-2	10' PKG	160-2 RIV - 10'	50209
	10' PKG	160-2 DET - 10'	30470
2-1/4" - 180-2	10' PKG	180-2 DET-10'	31014
2-1/2" - 200-2	5' PKG	200-2 RIV-5'	50220
	5' PKG	200-2 DET-5'	30496
3" - 240-2	5' PKG	240-2 DET-5'	58301

STEEL - TRIPLE STRAND

Chain Pitch & Number	Standard Package Quantities	Catalog Number	Item Code
1/4" - 25-3*	10' PKG	25-3-10'	45890
3/8" - 35-3*	10' PKG	35-3-10'	69057
1/2" - 40-3	10' PKG	40-3-10'	69060
5/8" - 50-3	10' PKG	50-3-10'	69063
3/4" - 60-3	10' PKG	60-3- RIV - 10'	69066
	10' PKG	60-3 DET - 10'	68934
1" - 80-3	10' PKG	80-3 RIV - 10'	68818
	10' PKG	80-3 DET - 10'	68822
1-1/4" - 100-3	10' PKG	100-3 RIV - 10'	69081
	10' PKG	100-3 DET - 10'	69082
1-1/2" - 120-3	10' PKG	120-3 RIV - 10'	69083
	10' PKG	120-3 DET - 10'	69087
1-3/4" - 140-3	10'2-1/2" PKG	140-3DET-10'2-1/2"	31142
2" - 160-3	5' PKG	160-3 DET-5'	31148
2-1/4" - 180-3	5' PKG	180-3 DET-5'	31160
2-1/2" - 200-3	5' PKG	200-3 DET-5'	30966
3" - 240-3	5' PKG	240-3 DET-5'	58304
STEEL - QUAD STRAND			
3/8" - 35-4*	10' PKG	35-4-10'	68839
1/2" - 40-4	10' PKG	40-4-10'	68842
5/8" - 50-4	10' PKG	50-4-10'	68843
3/4" - 60-4	10' PKG	60-4 RIV - 10'	68932
	10' PKG	60-4 DET - 10'	68933
1" - 80-4	10' PKG	100-4 RIV - 10'	50216
1-1/2" - 120-4	10' PKG	120-4 DET - 10'	31184
1-3/4" - 140-4	5' PKG	140-4 DET - 5'	31190
2" - 160-4	5' PKG	160-4 DET - 5'	31154
2-1/2" - 200-4	5' PKG	200-4 DET - 5'	31172
STAINLESS STEEL			
1/4" - 25*	10' PKG	25SS - 10'	58285
	100' REEL	25SS - 100'	69056
3/8" - 35*	10' PKG	35SS - 10'	30078
1/2" - 40	10' PKG	40SS - 10'	30134
5/8" - 50	10' PKG	50SS - 10'	30272
3/4" - 60	10' PKG	60SS - 10'	30328
1" - 80	10' PKG	80SS RIV - 10'	13493
NICKEL PLATED			
1/4" - 25*	10' PKG	25NP - 10'	68709
	100' REEL	25NP - 100'	68710
	10' PKG	35NP - 10'	68713
3/8" - 35*	100' PKG	35NP - 100'	68714
	10' PKG	40NP - 10'	68718
1/2" - 40	100' REEL	40NP - 100'	68719
	10' PKG	50NP - 10'	68723
	100' REEL	50NP - 100'	68724
5/8" - 50	250' REEL	50NP - 250'	68725
	10' PKG	60NP - 10'	68728
3/4" - 60	100' REEL	60NP - 100'	68729
	10' PKG	80NP - 10'	68732

* Non Roller

‡ Heavy Series chain has thicker link plates to resist shock from pulsating loads.

DET → Cottered

HEAVY SERIES‡

Chain Pitch & Number	Standard Package Quantities	Catalog Number	Item Code
3/4" - 60H	10' PKG	60H RIV - 10'	68994
		60H DET - 10'	68981
1" - 80H	10' PKG	80H RIV - 10'	69077
		80H DET - 10'	69079
1-1/4" - 100H	10' PKG	100H RIV - 10'	30958
		100H DET - 10'	30956
1-1/2" - 120H	10' PKG	120H RIV - 10'	06401
		120H DET - 10'	30960
1-3/4" - 140H	10'2-1/2" PKG	140HRIV-10'2-1/2"	50218
		140HDET-10'2-1/2"	30962
2" - 160H	10' PKG	160H RIV - 10'	30234
		160H DET - 10'	30964
2-1/2" - 200H	10' PKG	200H DET - 10'	58293

G

Roller Chains

ANSI Standard

Double, Triple and Quadruple Widths Dimensions

ALL DIMENSIONS IN INCHES

Chain Number	Pitch	E	H Roller Diam.	A	B	C	T	F	Pin Diam. G	Average Ultimate Strength Lbs.	Avg. Weight Per Ft. Lbs.
SINGLE WIDTH											
25*	1/4	.125	.130	.31	.19	.15	.030	.23	.0905	930	.104
35*	3/8	.187	.200	.47	.34	.23	.050	.36	.141	2,300	.21
40	1/2	.312	.312	.65	.42	.32	.060	.46	.156	3,700	.41
S41	1/2	.250	.306	.51	.37	.26	.050	.39	.141	2,580	.28
50	5/8	.375	.400	.79	.56	.40	.080	.59	.200	6,400	.69
60	3/4	.500	.468	.98	.64	.49	.094	.70	.234	8,700	.96
80	1	.625	.625	1.28	.74	.64	.125	.93	.312	15,500	1.60
100	101/4	.750	.750	1.54	.91	.77	.156	1.16	.375	24,000	2.56
120	1-1/2	1.000	.875	1.94	1.14	.97	.187	1.38	.437	34,000	3.60
140	1-3/4	1.000	1.000	2.08	1.22	1.04	.218	1.63	.500	46,000	4.90
160	2	1.250	1.125	2.48	1.46	1.24	.250	1.88	.562	58,000	6.40
180	2-1/4	1.406	1.406	2.81	1.74	1.40	.281	2.13	.687	80,000	8.70
200	2-1/2	1.500	1.562	3.02	1.86	1.51	.312	2.32	.781	95,000	10.30
240	3	1.875	1.875	3.76	2.27	1.88	.375	2.80	.937	130,000	16.90
DOUBLE WIDTH											
25-2*	1/4	.125	.130	.56	.31	.28	.030	.23	.0905	1,860	.20
35-2*	3/8	.187	.200	.86	.50	.43	.050	.36	.141	4,600	.41
40-2	1/2	.312	.312	1.20	.67	.60	.060	.46	.156	7,400	.81
50-2	5/8	.375	.400	1.49	.82	.75	.080	.59	.200	12,800	1.35
60-2	3/4	.500	.468	1.87	1.02	.93	.094	.70	.234	17,400	1.90
80-2	1	.625	.625	2.42	1.32	1.21	.125	.93	.312	31,000	3.15
100-2	1-1/4	.750	.750	2.94	1.62	1.47	.156	1.16	.375	48,000	5.00
120-2	1-1/2	1.000	.875	3.72	2.04	1.86	.187	1.38	.437	68,000	7.10
140-2	1-3/4	1.000	1.000	4.00	2.19	2.00	.218	1.63	.500	92,000	9.50
160-2	2	1.250	1.125	4.80	2.63	2.40	.250	1.88	.562	116,000	17.60
180-2	2-1/4	1.406	1.406	5.40	2.94	2.70	.281	2.13	.687	160,000	17.60
200-2	2-1/2	1.500	1.562	5.86	3.28	2.93	.312	2.32	.781	190,000	21.00
240-2	3	1.875	1.875	7.22	4.00	3.61	.375	2.80	.937	260,000	33.10
TRIPLE WIDTH											
25-3*	1/4	.125	.130	.81	.44	.41	.030	.23	.0905	2,790	.30
35-3*	3/8	.187	.200	1.26	.70	.63	.050	.36	.141	6,900	.60
40-3	1/2	.312	.312	1.78	.96	.89	.060	.46	.156	11,100	1.20
50-3	5/8	.375	.400	2.20	1.17	1.10	.080	.59	.200	19,200	2.05
60-3	3/4	.500	.468	2.75	1.46	1.37	.094	.70	.234	26,100	2.75
80-3	1	.625	.625	3.58	1.90	1.79	.125	.93	.312	46,500	4.80
100-3	1-1/4	.750	.750	4.35	2.33	2.18	.156	1.16	.375	72,000	7.30
120-3	1-1/2	1.000	.875	5.52	2.94	2.76	.187	1.38	.437	102,000	10.70
140-3	1-3/4	1.000	1.000	5.94	3.16	2.97	.218	1.63	.500	138,000	15.00
160-3	2	1.250	1.125	7.10	3.78	3.55	.250	1.88	.562	174,000	19.40
180-3	2-1/4	1.406	1.406	8.00	4.22	4.00	.281	2.13	.687	240,000	26.50
200-3	2-1/2	1.500	1.562	8.68	4.70	4.34	.312	2.32	.781	285,000	31.00
240-3	3	1.875	1.875	10.70	5.74	5.35	.375	2.80	.937	390,000	49.20
QUADRUPLE WIDTH											
25-4*	1/4	.125	.130	1.06	.56	.53	.030	.23	.0905	3,720	.45
35-4*	3/8	.187	.200	1.65	.90	.83	.050	.36	.141	9,200	.82
40-4	1/2	.312	.312	2.33	1.24	1.17	.060	.46	.156	14,800	1.60
50-4	5/8	.375	.400	2.91	1.53	1.45	.080	.59	.200	25,600	2.75
60-4	3/4	.500	.468	3.64	1.90	1.82	.094	.70	.234	34,800	3.70
80-4	1	.625	.625	4.73	2.47	2.37	.125	.93	.312	62,000	6.40
100-4	1-1/4	.750	.750	5.76	3.03	2.88	.156	1.16	.375	96,000	9.80
120-4	1-1/2	1.000	.875	7.30	3.83	3.65	.187	1.38	.437	136,000	14.20
140-4	1-3/4	1.000	1.000	7.86	4.12	3.93	.218	1.63	.500	184,000	20.00
160-4	2	1.250	1.125	9.40	4.93	4.70	.250	1.88	.562	232,000	25.00
180-4	2-1/4	1.406	1.406	10.58	5.52	5.29	.281	2.13	.687	320,000	35.00
200-4	2-1/2	1.500	1.562	11.50	6.10	5.75	.312	2.32	.781	380,000	41.50
240-4	3	1.875	1.875	14.14	7.47	7.07	.375	2.80	.937	520,000	65.00

*Non-Roller

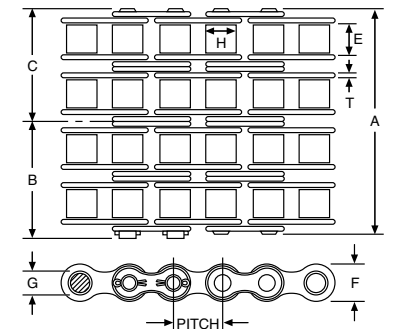
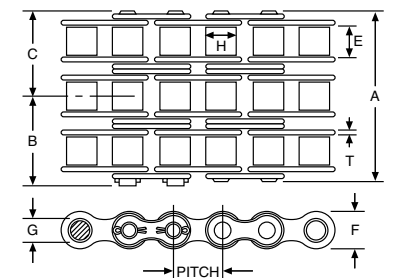
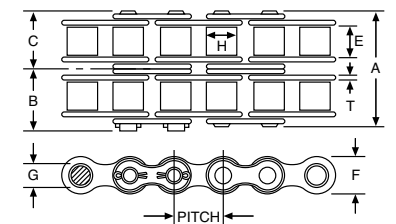
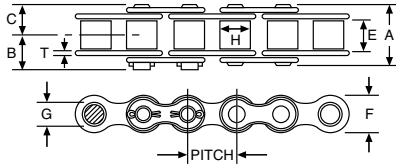

G

Roller Chains

Transmission/Conveyor/Heavy Series

Double Pitch Dimensions

Transmission Series

ALL DIMENSIONS IN INCHES

Chain Number	Pitch	E Width	H Dia.	A	B	C	T Thickness	F	G Pin Dia.	Avg. Ultimate Strgth. (Lbs.)	Avg. Wgt. Per Foot Lbs.
2040	1	.312	.312	.65	.42	.32	.060	.46	.156	3,700	.30
2050	1-1/4	.375	.400	.79	.56	.40	.080	.59	.200	6,100	.45
2060	1-1/2	.500	.468	.98	.64	.49	.094	.69	.234	8,500	.68
2080	2	.625	.625	1.28	.74	.64	.125	.88	.312	14,500	1.11
2100	2-1/2	.750	.750	1.54	.91	.77	.156	1.16	.375	24,000	1.94

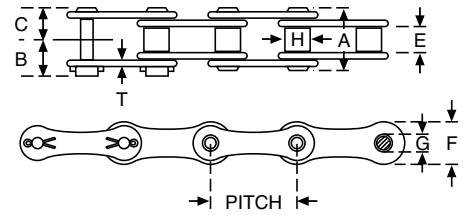

Conveyor Series

OVERSIZE ROLLERS

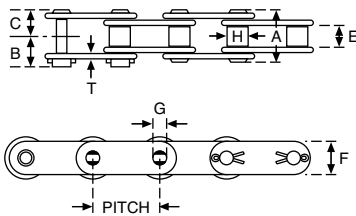

STANDARD ROLLERS

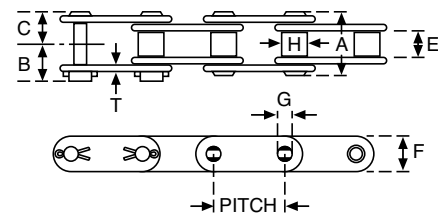

ALL DIMENSIONS IN INCHES

Chain Number	Pitch	E	H		A	B	C	T	F	G	Avg. Ultimate Strgth. (Lbs.)	Avg. weight per foot (Lbs.)		
			Std. Roller	Over-Size Roller								Std. Roller	Over-size Roller	Thermo-plastic Roller
C2040	1	.312	.312	.625	.65	.42	.32	.060	.46	.156	3,700	.32	.55	.33
C2050	1-1/4	.375	.400	.750	.79	.56	.40	.080	.59	.200	6,100	.53	.84	.54
C2060H	1-1/2	.500	.468	.875	1.11	.65	.55	.125	.69	.234	8,500	.92	1.40	.94
C2080H	2	.625	.625	1.125	1.41	.80	.70	.156	.88	.312	14,500	1.52	2.21	1.52
C2100H	2-1/2	.750	.750	1.562	1.67	.98	.83	.187	1.15	.375	24,000	2.30	3.75	—
C2120H	3	1.000	.875	1.750	2.07	1.21	1.03	.218	1.37	.437	34,000	3.70	5.71	—
C2160H	4	1.250	1.125	2.250	2.60	1.52	1.30	.281	1.87	.562	58,000	5.85	8.93	—

Heavy Series

ALL DIMENSIONS IN INCHES

Chain Number	Pitch	E	H	A	B	C	T	F	G	Avg. Ultimate Strgth. (Lbs.)	Avg. Wgt. Per Foot Lbs.
60H	3/4	.500	.468	1.11	.65	.55	.125	.680	.234	8,500	1.14
80H	1	.625	.625	1.41	.80	.70	.156	.930	.312	14,500	1.93
100H	1-1/4	.750	.750	1.67	.98	.83	.187	1.156	.375	24,000	3.06
120H	1-1/2	1.000	.875	2.07	1.21	1.03	.218	1.375	.437	34,000	4.45
140H	1-3/4	1.000	1.000	2.20	1.28	1.10	.250	1.625	.500	46,000	5.68
160H	2	1.250	1.125	2.60	1.52	1.30	.281	1.875	.562	58,000	7.33
180H	2-1/4	1.406	1.406	2.95	1.75	1.48	.312	2.130	.687	80,000	9.10
200H	2-1/2	1.500	1.562	3.63	2.02	1.66	.375	2.312	.781	95,000	13.50

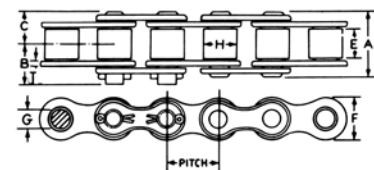

Conveyor Chain Selection

Single or Double Pitch, Flat-Top and Hollow Pin Chain

In order to select a chain for a conveyor application, the Velocity and maximum Chain Pull must be established. The total pull may be obtained if the Torque and Sprocket PD are known, or if the Horsepower and Velocity can be determined.

$$\text{Chain Pull, } W = \frac{2T}{D}$$

$$W = \frac{33000 P}{V}$$

$$W = \frac{126050 P}{nD}$$

W = Chain Pull, Lbs.
 T = Torque, In. Lbs.
 D = Sprocket PD, Inches
 P = Horsepower
 V = Chain Velocity, FPM
 n = Sprocket Speed, RPM

If a pair of chains are used, the pull on each chain will be half of the total chain pull.

Having determined the Chain Pull, refer to Chain Load Rating Charts on Page 247 and select a chain with a capacity equal to or greater than the Chain Pull Required.

To Calculate Chain Length (L):

For Single Pitch Chain

$$L = 2C + N$$

For Double Pitch & Flat-Top Chain

$$L = 2C + \frac{N}{2}$$

where:

L = Chain Length, Pitches

C = Center Distance, Pitches

N = Number of Teeth in One Sprocket*

The computed value of L must be rounded out to a larger whole number of pitches (links) for each complete chain. Any whole number of links is satisfactory for Hinge-Top Chain but an even number should be selected for Single or Double Pitch or Flat-Top Chains.

To obtain the center distance or chain length in inches, the value in pitches should be multiplied by the chain pitch.

Example 1. Selecting a Double Pitch Conveying Chain.

The power required to move material at 50 FPM is 1 Horsepower on a Conveyor with a Center Distance of 10 ft.

Step I: Determine Chain Pull:

$$W = \frac{33,000 P}{V} = \frac{33000 \times 1}{50} = 660 \text{ Lbs.}$$

Step II: Refer to Conveyor Chain Load Rating Chart, page 165. Select a double pitch chain with a Working Load equal to or greater than 660 lbs. at 50 FPM. Selection — C2050 (1.25" Pitch) with 5/8 pitch sprockets 50B25 (or larger).

Step III: Determine Chain Length in Pitches. Convert Center Distance (10 feet) to pitches.

$$C = \frac{10 \times 12}{1.25} = 96 \text{ Pitches}$$

$$\text{Chain Length (L)} = 2C + \frac{N}{2}$$

$$\text{Chain Length (L)} = 2 \times 96 + \frac{25}{2} = 204.5$$

Adjust to next larger even whole number.

Chain Length (L) = 206 Pitches

*Assuming same size Driver and Driven Sprockets.

Single Pitch & Double Pitch Chain

For horizontal conveyor applications where the HP or Torque data is not available, the approximate Chain Pull can be calculated from the Weight to be moved (product and chain) and the Coefficient of Friction (between sliding surfaces of chain and supporting ways).

For Normal operation:

Chain Pull

$$W = (M + 2m) Cf$$

W = Chain Pull Lbs.

M = Product Weight, Lbs. per Ft.

m = Chain Weight, Lbs. per Ft.

C = Conveyor Length (between Centers), Ft.

f = Coefficient of Friction (see Table).

For trial purposes,

let $m = 1.0$ for other conveyor chains.

Note: The estimated weight of pins and/or attachments (per foot of chain) should be included in chain weight.

Whenever the product becomes stalled on a moving conveyor, the chain pull is increased. The Added Pull depends on the Stalled Weight (of product) and the Coefficient of Friction (between surfaces of product and chain).

For stalled product:

Added Chain Pull,

$$w = Mlf$$

w = Added Chain Pull, Lbs.

M = Product Weight, Lbs. per Ft.

l = Length of Stalled Product, Ft.

f = Coefficient of Friction (see Table).

For Stalled condition:

Total Chain Pull = $W + w$, Lbs.

If a pair is used, the pull on each chain will be half of the total chain pull.

Conveyor Chain Selection (Continued)

Example 2. A horizontal conveyor 25 Ft. long is to move a product weighing 200 Lbs. per Ft. at 20 FPM. Two FT2060 Flat-Top chains will be used, if possible, with the thermoplastic plates supported on metal ways without lubrication.

Chain Pull,

$$W = (M + 2m) Cf$$

$$M = 200 \text{ Lbs. per Ft.}$$

$$m = 1.41 \times 2 = 2.82 \text{ (two chains)}$$

$$C = 25 \text{ Ft.}$$

$$f = .25 + .15 = .40 \text{ (for starting with load)}$$

$$W = (200 + 5.64) 25 \times .40 = 2056 \text{ Lbs.}$$

The maximum working load of FT2060 chain at 20 FPM is 1170 Lbs. (see table) and this will be adequate if the product cannot become stalled.

Note: Whenever two strands of chain are used, the total chain weight will be double the single strand weight, (per foot).

COEFFICIENT OF FRICTION FOR CONVEYOR CHAIN

Plate Material	Stainless Steel	Carbon Steel	Delrin	Nylon	High Density Polyethylene	Impregnated Wood
Stainless Steel						
Dry	.41	.41	.30	.35	.15	.11
Water	.35	.35	.25	.30	.12	.11
Soap & Water	.20	.20	.25	.20	.08	.11
Carbon Steel						
Dry	.41	.39	.30	.35	.15	.11
Water	.35	.35	.25	.30	.12	.11
Soap	.20	.20	.15	.20	.08	.11
Acetal Plastic						
Dry	.30	.30				.20
Water	.25	.25				.20
Soap & Water	.15	.15				.10
Nylon						
Dry	.35	.35				.25
Water	.30	.30				.25
Soap & Water	.20	.20				.12

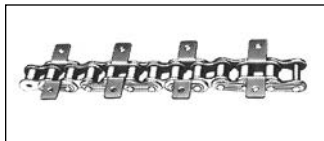

**SINGLE PITCH
ROLLER CHAIN WITH
ATTACHMENTS**

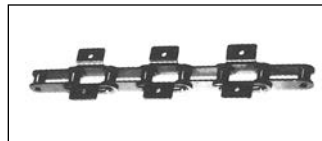

**DOUBLE PITCH
ROLLER CHAIN WITH
ATTACHMENTS**

To select the proper chain, the working load or chain pull and the chain speed in feet per minute must be known. Using this information find the proper chain in the chart.† These load ratings are based on proper installation, lubrication and steady load conditions.

The minimum permissible number of sprocket teeth is 15 for single pitch, and 24 for double pitch chain. For smoother operation, sprockets with greater numbers of teeth than the minimum are recommended.

CHAIN LOAD RATING CHART

Single Pitch	Chain Numbers							
	35*	40	50	60	80	100	120	160
Double Pitch		C2040	C2050	C2060	C2080	C2100	C2120	C2160
Velocity of Chain (FPM)	Maximum Working Load or Chain Pull (Lbs.)							
25	250	443	690	995	1770	2760	3990	7100
50	243	432	675	970	1730	2690	3880	6900
75	233	414	645	930	1660	2580	3720	6630
100	220	391	610	880	1570	2440	3520	6250
125	206	366	570	820	1460	2280	3290	5850
150	190	338	528	760	1350	2110	3040	5400
175	175	311	485	700	1240	1940	2800	4970
200	160	284	444	640	1140	1770	2560	4550
225	146	259	405	584	1040	1620	2340	4150
250	133	236	368	530	940	1470	2120	3770
275	120	214	333	480	855	1330	1920	3310
300	110	195	305	440	780	1220	1760	3120
Standard Pitch Boston Sprockets To Operate With Above Chain								
Pitch	3/8"	1/2"	5/8"	3/4"	1"	1-1/4"	1-1/2"	2"

*No. 35 Chain is a Rollerless Chain.

†For Hollow Pin chains, the working load (chain pull) should be multiplied by 1.3 to obtain the proper value for use in selecting the chain pitch required.

Flat Top Conveyor Chain

MAXIMUM WORKING LOAD OR CHAIN PULL (LBS.)

Chain Type	Chain Velocity — Feet Per Minute					
	0-10	20	30	40	50	70
FT2060	1070	1045	1035	1030	1025	1015

MAXIMUM WORKING LOAD OR CHAIN PULL (LBS.)

Chain Type	Chain Velocity — Feet Per Minute					
	100	150	200	250	300	400
FT2060	1005	960	915	855	670	435

LUBRICATION - To assure maximum chain life, carbon and stainless steel chains should be lubricated wherever possible. Soap lubrication is recommended. Several detergent and nonalkali fluid types are on the market. Water lubrication should be used when no other lubricant can be tolerated. Drip-type systems and wheel-type and sponge-type applicators are on the market.

Delrin chain tends to be self-lubricating, although wear life can be extended with the use of a lubricant, such as soap and water.

Conveyor Chain Working Load

At speeds of normal conveyor operation (less than 500 feet per minute), chains are selected on the basis of safe working load, rather than horsepower capacity. Working load or chain pull of conveyor series chains is calculated by multiplying the total combined weight of the chain, plus the conveyed material in any run, by the appropriate coefficient of friction. In general, the maximum working load for a conveyor chain will be higher than that

determined for similar chains from a horsepower rating table. The higher load is permitted because there are usually fewer load cycles on a conveyor chain, compared to a power transmission drive. In order to minimize wear, permissible working loads of conveyor chains are reduced as speeds increase. See the working load table below.

COEFFICIENT OF FRICTION – DOUBLE PITCH ROLLER CHAINS

Chain Number	Chain with Large Size Rollers and Rolling Friction				Chain with Standard Size Rollers and Sliding Friction			
	*Static		Rolling		*Static		Sliding	
	Dry	Lubricated	Dry	Lubricated	Dry	Lubricated	Dry	Lubricated
C-2040, C-2042	0.17	0.12	0.14	0.10	.33	.24	.27	.21
C-2050, C-2052	0.16	0.11	0.13	0.09				
C-2060H, C-2062H	0.16	0.11	0.13	0.09				
C-2080H, C-2082H	0.15	0.10	0.12	0.08				
C-2100H, C-2102H	0.14	0.09	0.11	0.07				
C-2120H, C-2122H	0.14	0.09	0.11	0.07				
C-2160H, C-2162H	0.13	0.08	0.10	0.07				

*For chain speed of 3 feet per minute or less

RECOMMENDED MAXIMUM WORKING LOADS

Chain Number	Pitch in Inches	Chain Speed, feet per minute								
		5	25	50	75	100	200	300	400	500
		Maximum Working Load, Lbs.								
C-2040, C-2042	1	530	525	510	490	465	335	230	160	115
C-2050, C-2052	1 1/4	870	865	840	805	765	555	380	265	190
C-2060H, C-2062H	1 1/2	1215	1205	1170	1125	1065	775	530	370	265
C-2080H, C-2082H	2	2070	2055	2000	1915	1815	1320	905	630	455
C-2100H, C-2102H	2 1/2	3425	3400	3310	3175	3000	2180	1500	1040	750
C-2120H, C-2122H	3	4855	4815	4690	4495	4250	3090	2125	1480	1065
C-2160H, C-2162H	4	8585	8210	8000	7670	7250	5275	3625	2520	1815

Calculate the working load for horizontal, inclined, vertical and carousel conveyors, substituting the following values in the appropriate formulas:

- P = Chain pull or working load
- S = Speed in feet per minute
- L = Length of conveyor in feet between sprocket centers
- T = Total chain length in feet
- V = Vertical rise in feet
- F₁ = Coefficient of friction, sliding
- F₂ = Coefficient of friction, rolling
- W = Weight of chain and attachments per foot in pounds
- M = Weight of conveyed product per foot in pounds
- N = Number of chain strands

Horizontal Conveyor

$$P = \frac{LF(2W + M)}{N}$$

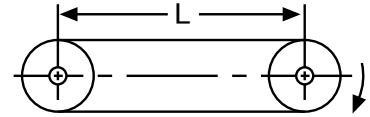

Inclined Conveyor

A factor must be added to or subtracted from the chain load to compensate for raising or lowering the conveyed load on an inclined installation. This factor may be calculated by multiplying the weight of conveyed load by the vertical change in feet, and dividing by the horizontal run of the conveyor in feet.

$$P = \frac{LF(2W + M) \cos \phi \pm LM \sin \phi}{N}$$

$$\phi = \text{ARC tan } \frac{V}{L_1}$$

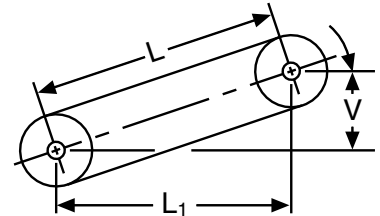

Vertical Conveyor

$$P = \frac{L(M + W)}{N}$$



Carousel Conveyor (Plan View) for Crescent Top Chains

$$P = \frac{TF(W + M) + (TMF)}{N}$$

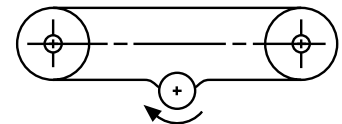

Note: (TMF) is the length of stalled product.

Roller Chain Formulas

Horsepower

Horsepower equals 33,000 foot-pounds per minute, or 550 foot-pounds per second. In terms of chain working load or pull (P) and speed:

$$HP = \frac{P \times S}{33,000}$$

$$HP = \frac{P \times \text{Number of Teeth} \times \text{Pitch} \times \text{RPM}}{396,000}$$

$$HP = \frac{\text{Torque (lb.-in.)} \times \text{RPM}}{63,025}$$

$$HP = \frac{\text{Torque (lb.-in.)} \times \text{RPM}}{5,252}$$

Ratio

$$\text{Ratio} = \frac{\text{Teeth in Large Sprocket}}{\text{Teeth in Small Sprocket}} \quad \text{or} \quad \frac{\text{Fast RPM}}{\text{Slow RPM}}$$

Chain Working Load

When horsepower input is known, calculate for chain working load or pull (P):

$$P = \frac{HP \times 33,000}{\text{FPM}}$$

$$P = \frac{HP \times 396,000}{\text{Number of Teeth} \times \text{Pitch} \times \text{RPM}}$$

$$P = \frac{\text{Torque}}{\text{Sprocket Pitch Radius}}$$

Chain Speed

$$\text{Speed (FPM)} = \frac{\text{Pitch} \times \text{Number of Teeth} \times \text{RPM}}{12}$$

Sprocket Speed

$$\text{RPM} = \frac{12 \times \text{RPM}}{\text{Number of Teeth} \times \text{Pitch}}$$

$$\text{RPM of Driven Sprocket} = \frac{\text{Driver Teeth} \times \text{Driver RPM}}{\text{Driven Teeth}}$$

$$\text{RPM of Driver Sprocket} = \frac{\text{Driven Teeth} \times \text{Driven RPM}}{\text{Driver Teeth}}$$

Centrifugal Pull or Tension

Pull or tension caused by chain weight and velocity:

$$\text{Centrifugal Pull} = \frac{\text{Chain Weight per Foot} \times (\text{FPM})^2}{115,900}$$

Total Chain Tension

Total Chain Tension = Working Load + Centrifugal Pull

Chain Bearing Pressure

$$\text{Bearing Pressure (pounds per square inch)} = \frac{\text{Working Load}}{\text{Bushing Length} \times \text{Pin Dia.}}$$

Torque

Torque = Sprocket Pitch Radius x Working Load

$$\text{Torque (lb.-in.)} = \frac{HP \times 63,025}{\text{RPM}}$$

$$\text{Torque (lb.-ft.)} = \frac{HP \times 5,252}{\text{RPM}}$$

Factory of Safety

$$FS = \frac{\text{Chain Ultimate Strength}}{\text{Chain Working Load}}$$

Ordering Procedure

Attachments may be ordered as separate links or assembled in chains.

WHEN ORDERING SEPARATE ATTACHMENT LINKS, THE FOLLOWING DATA MUST BE GIVEN:

1. Chain Number and Attachment Number.
2. Connecting Link or Roller Link.

WHEN ORDER ATTACHMENTS ASSEMBLED* IN CHAIN, THE FOLLOWING INFORMATION MUST BE SUPPLIED:

1. Chain Number and Attachment Number.
2. Spacing between Attachment Centers (Pitches or Inches). This must be a multiple of the chain pitch.
3. If spacing is an even number of pitches, attachments will be assembled as pin links unless roller link style is specified.
4. If spacing is an odd number of pitches, assembly will normally be supplied with alternate pin and roller link attachments. For attachments to be on pin (or roller) links only, an offset link must be assembled in each interval.

*Riveted assembly will be supplied unless detachable links are specified.

ANSI Standard Roller Chains



Standard Roller Chain Attachments

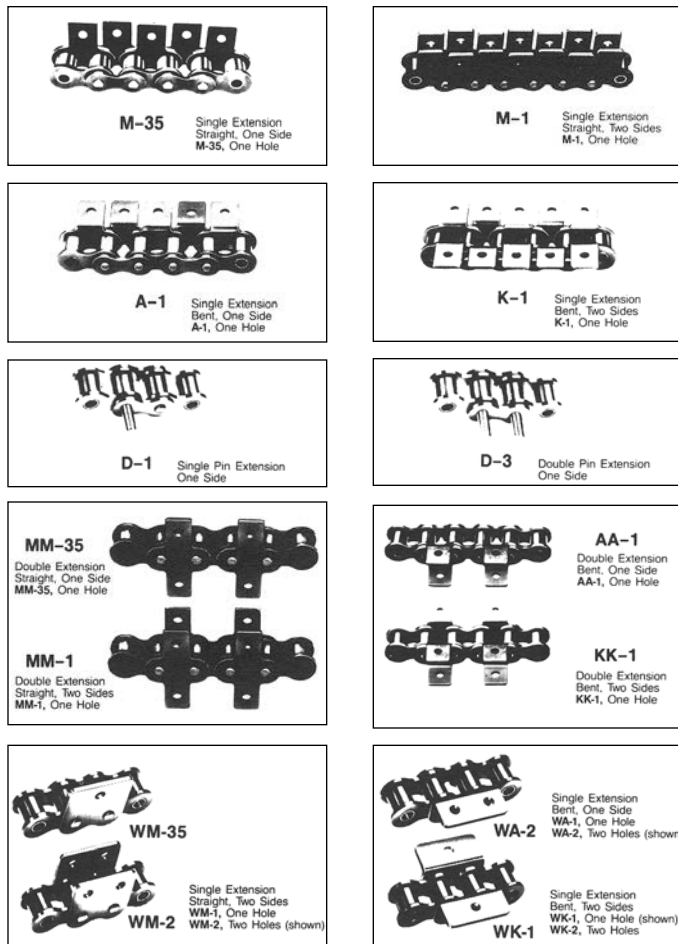

Double Pitch Roller Chains

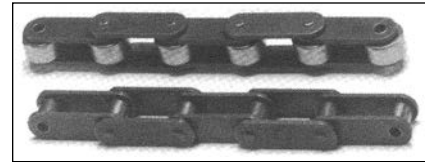

Double Pitch Chain Attachments

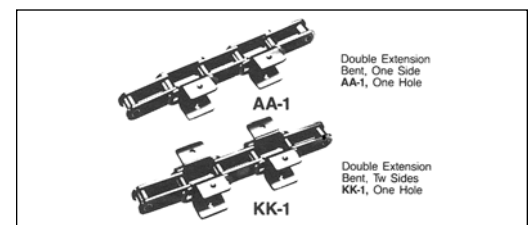
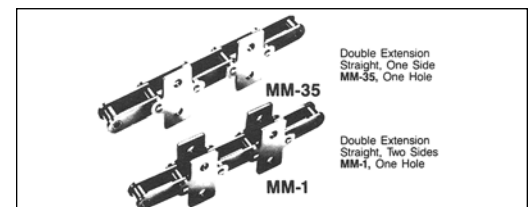
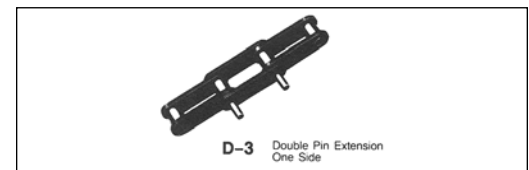
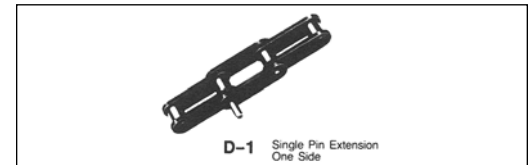
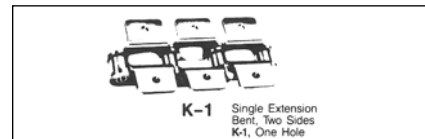
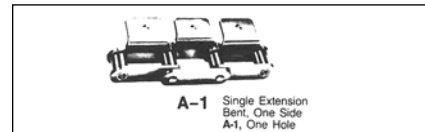
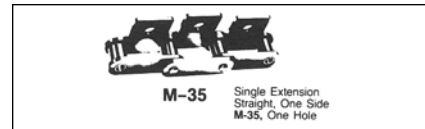

G

Roller Chains

Hollow Pin

Single and Double Pitch



Boston Gear Hollow Pin Chain is identical to ANSI Roller Chain in pitch, roller width and roller diameter. It is quality designed for long wear life in conveyor applications. The “hollow pin” feature provides unlimited conveyor design versatility. Stud, bushed design. Bushing diameter is same as comparable roller chain.

ORDER BY CATALOG NUMBER OR ITEM CODE

Chain Pitch and Number	Standard Package Quantities	Catalog Number	Item Code
SINGLE PITCH			
1/2" – 40HP	20' Pkg.	40HP – 20'	31088
5/8" – 50HP		50 HP – 20'	31092
3/4" – 60 HP		60 HP – 20"	31096
1" – 80 HP		80 HP – 20'	31100
DOUBLE PITCH – STANDARD ROLLERS			
1" – C2040HP	20' Pkg.	C2040HP – 20'	31104
1-1/4" – C2050HP		C2050 HP – 20'	31108
1-1/2" – C2060 HP		C2060 HP – 20"	31112
2" – C2080 HP		C2080 HP – 20'	31116
DOUBLE PITCH – OVERSIZE ROLLERS			
1" – C2042HP	20' Pkg.	C2042HP – 20'	50223
1-1/4" – C2052HP		C2052 HP – 20'	50224
1-1/2" – C2062 HP		C2062 HP – 20"	50225
2" – C2082 HP		C2082 HP – 20'	50226

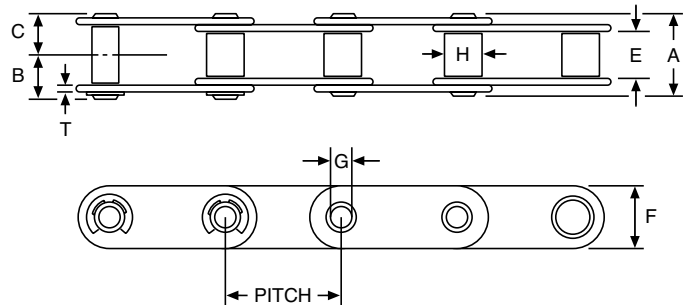
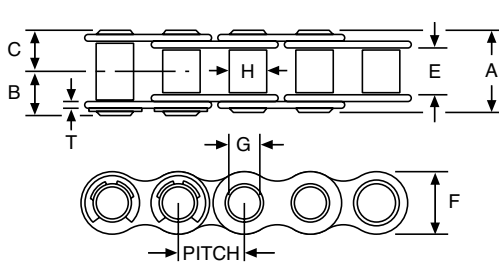

DIMENSIONS IN INCHES

Chain Pitch		E	H	A	B	C	T	F	G	Average Ultimate Strength (Lbs.)	Average Weight Per Foot (Lbs.)	
Single	Double										Single	Double
1/2	1	.312	.312	.65	.37	.32	.060	.46	.158	2500	.38	.31
5/8	1-1/4	.375	.400	.79	.46	.40	.080	.59	.203	3700	.63	.51
3/4	1-1/2	.500	.469	.97	.57	.49	.094	.69	.237	6100	.88	.75
1	2	.625	.625	1.22	.70	.61	.125	.88	.318	8500	1.56	1.33

ORDER BY CATALOG NUMBER OR ITEM CODE

Chain Number	Standard Package Quantities	Catalog Number	Item Code
B503	25' Pkg.	B503-25'	30602
B504		B504-25'	30608
B505		B505-25'	30614
B506		B506-25'	30620

STAINLESS STEEL Block Chain available on Special Order. Contact Factory.

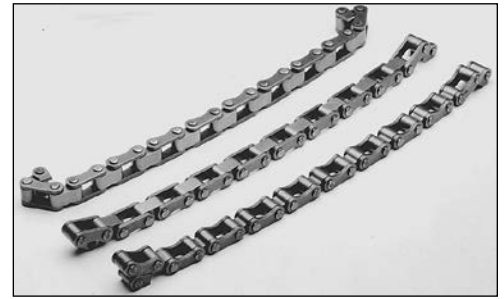

ALL DIMENSIONS IN INCHES

Chain No.	Pitch	W	From Pin Head to C/L	From Pin Head to C/L	Over-All Width		Link Plate Thickness	Pin Dia. E	Average Weight Per Foot, (Lbs.)
			A	B	Riv.	Sp Cl			
B503	1	1/4	7/32	17/64	7/16	31/64	0.060	0.170	0.3
B504	1	5/16	9/32	5/16	9/16	19/32	0.080	0.187	0.4
B505	1	3/8	5/16	11/32	5/8	21/32	0.080	0.187	0.4
B506	1	1/2	3/8	13/32	3/4	25/32	0.080	0.187	0.5

*Refer to Page 298 for Block Chain Sprockets

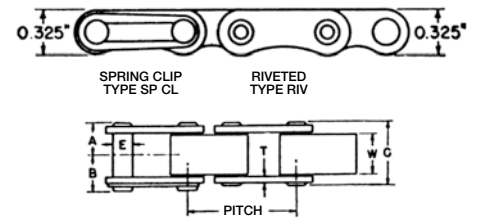

Leaf (Cable) Chain

Boston Leaf Chains are designed for tension linkage applications such as counterweight chains for machine tools, elevator and oven doors, fork lift truck masts, spinning frames, i.e. applications to lift or pull where it is not necessary to engage a sprocket.

Leaf chains normally run over sheaves and are attached to clevises at each end. Because of the wide variation in clevis designs, leaf chains are furnished less the end pins.

Not recommended for new applications.



ORDER BY CHAIN NUMBER AND LENGTH IN FEET

Chain Pitch	Lacing	A	G	H	T	Average Ultimate Strength (Lbs.)	Weight Per Foot (Lbs.)	Chain Number
1/2	2 x 3	.50	.200	.455	.080	6,000	.48	BL-423
1/2	3 x 4	.67	.200	.455	.080	9,000	.64	BL-434
1/2	4 x 6	.92	.200	.455	.080	12,000	.93	BL-446
5/8	2 x 3	.58	.234	.585	.094	9,000	.74	BL-523
5/8	3 x 4	.78	.234	.585	.094	13,200	1.03	BL-534
5/8	3 x 4	1.07	.234	.585	.094	18,000	1.46	BL-546
3/4	2 x 3	.76	.312	.708	.125	13,200	1.15	BL-623
3/4	3 x 4	1.02	.312	.708	.125	20,400	1.60	BL-634
3/4	4 x 6	1.41	.312	.708	.125	26,400	2.30	BL-646
1	2 x 3	.94	.375	.950	.156	22,800	1.91	BL-823
1	3 x 4	1.26	.375	.950	.156	34,800	2.66	BL-834
1	4 x 6	1.41	.375	.950	.156	45,600	3.78	BL-846

STANDARD LACING TABLE

2 x 3

3 x 4

4 x 6

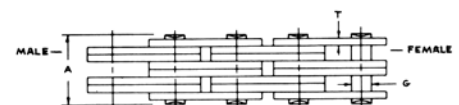

When ordering chain with odd number of pitches specify whether male or female end link required.

Ladder Chain

Steel–Stainless Steel–Brass

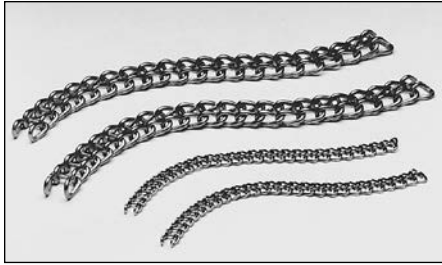

An effective, low-cost means of transmitting motion where load (torque) is not a critical factor.

In addition to stock-listed sizes and materials, ladder chain can be furnished pre-assembled into endless lengths to customer specifications or pre-cut to desired lengths.

Ladder chain may be made into endless loops by opening the two eyes of one end link with needle-nosed pliers to permit entry of the other end link and then closing the open eyes.

Ladder chain can be furnished on a made-to-order basis made endless, with special plating. Consult the factory for prices.

ORDER BY CATALOG NUMBER OR ITEM CODE*

Chain Number	Standard package Quantities	Catalog Number	Item Code
1AA Miniature	*	1AA Stainless Steel	54941
1	50' Pkg.	1 BRASS—50' 1 HITEN—50' 1 STEEL—50' 1 SS—50'	31200 31208 31216 46847
1A	50' Pkg.	1A BRASS—50' 1A HITEN—50' 1A STEEL—50' 1A SS—50'	31202 31210 31218 46848
2	50' Pkg.	2 BRASS—50' 2 HITEN—50' 2 STEEL—50' 2 SS—50'	31204 31212 31220 46849
2-1/2	50' Pkg.	2A BRASS—50' 2A HITEN—50' 2A STEEL—50' 2A SS—50'	31206 31214 31222 46850

*To order Miniature Ladder Chain, specify Item Code and Number of Feet required. For Sprockets to run with this Chain, see Miniature Roller Chain Sprockets, Page 274.

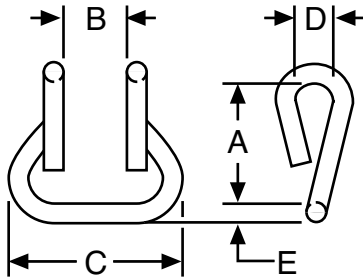

ALL DIMENSIONS IN INCHES

Chain Number	Links per Foot (Approx.)	A		B Min.	C Max.	D Max.	E ±.0005	Weight Per 100 Ft. (Lbs.)	
		Min.	Max.					Steel	Brass
1AA	82	.1465	.1485	.079	.229	—	.031	—	—
1A	65	.1840	.1852	.115	.315	.072	.041	2.85	3.06
1	42	.2846	.2869	.125	.350	.091	.047	3.38	3.04
2	34	.3514	.3546	.180	.480	.115	.054	4.20	4.50
2-1/2	34	.3507	.3553	.195	.565	.155	.080	10.30	11.10

Load Data

Chain Number	Approx. Yield Point (In Pounds)				Approx. HP at 500 RPM			
	Steel			Brass	Steel			
	Untreated	High Tensile	Stainless		Untreated	High Tensile	Stainless	Brass
1A	20	40	20	15	1/6	1/3	1/6	1/8
1	40	70	25	25	1/4	1/2	3/16	1/6
2	50	90	35	30	1/3	3/4	1/4	1/4
2-1/2	75	140	65	45	1/2	1	7/16	1/3

Ratings for 1AA Chain will be furnished on request.

Miniature Roller Chains

Stainless Steel – Single Strand Riveted

MATERIAL: Stainless Steel Type 18-8
FINISH: Clear Passivated
AVERAGE TENSILE LOAD: 180 lbs.
WEIGHT: .035 lbs. per foot

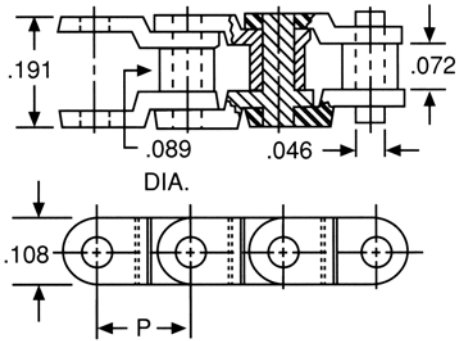

ORDER BY CATALOG NUMBER OR ITEM CODE

Item Number	Catalog Number	No. of Links	Length
54919	15SS50	50	7.375
54920	15SS60	60	8.850
54921	15SS70	70	10.325
54922	15SS80	80	11.800
54923	15SS90	90	13.275
54924	15SS100	100	14.750
54925	15SS110	110	16.225
54926	15SS120	120	17.700
54927	15SS130	130	19.175
54928	15SS140	140	20.650
54929	15SS150	150	22.125
54930	15SS160	160	23.600
54931	15SS170	170	25.075
54932	15SS180	180	26.550
54933	15SS190	190	28.035
54934	15SS200	200	29.500
54935	15SS210	210	30.975
54936	15SS220	220	32.450
54937	15SS230	230	33.925
54938	15SS240	240	35.400

NOTE: Sizes not listed are available on request.
 All lengths include and are supplied with connecting link 15SS C/L

PRICED PER FOOT

Item Number	Catalog Number	Material	P Pitch	Links per Foot	Weight per Foot
54939	6M-7-MS	Nylatron GS	.1475	81.3	.093 oz.

CONNECTING LINK

BUSHING LINK

Catalog Number	Item Code	Catalog Number	Item Code
54942	15SS C/L	54943	15SS B/L

Chain Pullers

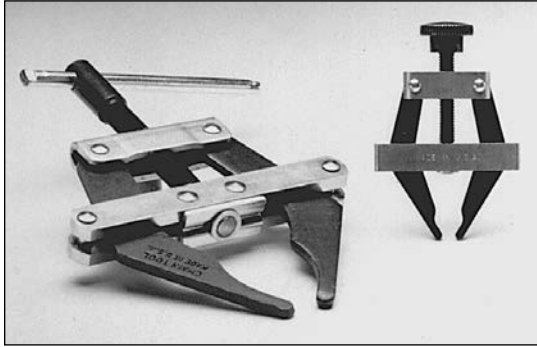

The Boston Chain Puller was designed to make roller chain installation quick and easy.

To use: (1) hook the two jaws into each end of the chain; (2) turn the screw until the two ends almost meet; (3) insert the connecting link and fasten.

ORDER BY CATALOG NUMBER OR ITEM CODE

Chain Sizes	Jaw Spread	Catalog Number	Item Code
Nos. 35-60	2"	TH35-60	10784
80-240	5"	TH80-240	10788

G

Chain Breaking Tools

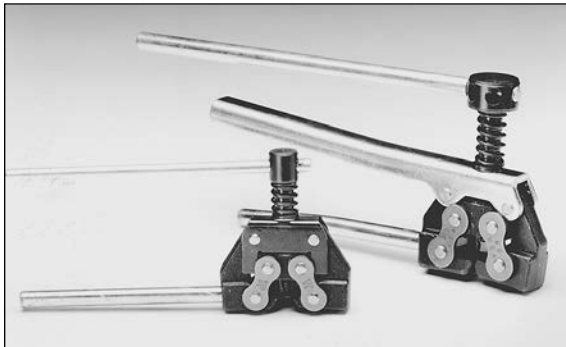

These Boston Chain Breaking Tools will disconnect any riveted roller chain manufactured to ANSI specifications, up to and including No. 100 (1-1/4" pitch).

Tool steel replaceable punch point, tempered for long life.

ORDER BY CATALOG NUMBER OR ITEM CODE

Chain Sizes	Catalog Number	Item Code	Replaceable Points	
			Catalog Number	Item Code
Nos. 25-60 60-100	CBT-60	06800	XCBT 60-5	06808
	CBT-100	63526	XCBT 100-5	63587



Section Contents

ROLLER CHAIN DRIVES	
General Description.....	266-267
Horsepower Ratings Charts	268-270
Selection Charts	271-273
MINIATURE CHAIN SPROCKETS	
Catalog Number Selections/Dimensions	274
ROLLER CHAIN SPROCKETS	
Catalog Number Selections/Dimensions	275-297
BLOCK CHAIN SPROCKETS	
Catalog Number Selections/Dimensions	298
LADDER CHAIN SPROCKETS	
Catalog Number Selections/Dimensions	299-300
ROLLER CHAIN DRIVE TENSIONERS	
Catalog Number Selections/Dimensions	301-304
IDLER SPROCKETS	
Catalog Number Selections/Dimensions	301



Chain Drives

Roller Chain Sprockets

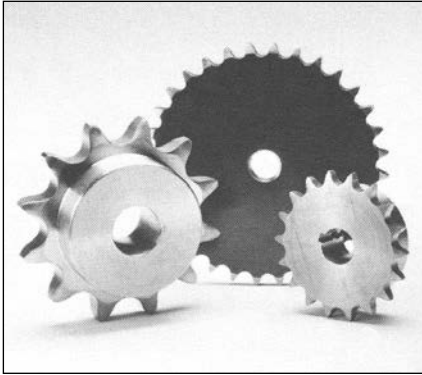

Boston roller chain sprockets are quality designed and built to ANSI specifications for superior fatigue resistance and long operational life in a host of industrial and process applications. Sprockets are available in a wide range of materials and pitches, with or without hubs.

Types and Styles

Type A – No Hub

Boston standard Type A sprockets are stocked for all single strand Roller Chains up to 1" Pitch (#80 Chain).

Type B – Single Hub

Boston Steel—Type B Stock Bore sprockets are stocked for all single strand Roller Chains up to 1" Pitch (#80 Chain) and for double strand Roller Chains in 3/8, 1/2, 5/8 and 3/4" Pitches.

Boston Stainless Steel—Type B Stock Bore sprockets are stocked for single strand Roller Chain in 1/4, 3/8, and 1/2" pitches.

Boston Steel—Type B Bored-to-Size sprockets are stocked for single strand Roller Chain in 1/4, 3/8, 1/2, 5/8, 3/4, and 1" pitches.

Boston Type B sprockets are solid (one piece) construction in small sizes, and two-piece design in larger numbers of teeth, see Chart.

Pitch Size	Solid up to	Two-Piece starting at
25	25B30	25B32
35	35B25	35B26
41	41B20	41B21
40	40B20	40B21
50	50B16	50B17
60	60B16	60B17
80	80B14	80B15

Roller Chain Drive Selection

The following considerations are very important in the selection and application of roller chain drives:

HORSEPOWER RATINGS—This catalog lists Horsepower Ratings for ANSI Series, single pitch, single strand chains No. 25 through No.160 (and lightweight machinery series No. 41).

Ratings are listed for various numbers of teeth and speeds of smaller sprocket. Ratings for intermediate numbers of teeth or RPM may be determined by interpolation. The ratings reflect a service factor of 1, a chain length of approximately 100 pitches, the use of recommended lubrication methods and a drive arrangement where two aligned sprockets are mounted on parallel horizontal shafts. For maximum service life, sprockets with small numbers of teeth, operating at moderate to high speeds or near the rated horsepower should have hardened teeth. Approximately 15,000 hours of service life at full load operation may be expected under these conditions.

NO. OF TEETH—It is good practice to select a pinion sprocket with no less than 17 Teeth, to assure 120° of chain wrap and minimize overhung load. However, certain conditions, i.e., space limitations, light loads, intermittent duty, etc. will permit the use of smaller pinions.

RATIO—Sprocket ratios should not exceed about 6 to 1 for normal chain life.

HARDENED TEETH—Boston Gear steel sprockets can be hardened. Consult the factory for recommended procedure.

CENTER DISTANCE—The correct center distance is very important. In designing chain drives, it is important that the Center Distance should be long enough to provide at least 120° of chain wrap on the smaller sprocket.

RELATIVE SHAFT LOCATIONS—It is desirable that the line between the two shaft centers be as nearly horizontal as possible. If this line is more than 60° from the horizontal, special precautions should be taken.

Roller Chain Drive Selection (Continued)

A roller chain consists essentially of numerous small bearings operating under high pressures and requires adequate lubrication. There are four basic types of lubrication suggested for chain drives, depending upon the chain speed and the power transmitted. The Horsepower Rating Tables indicate the type of lubrication recommended.

Type I—Manual Lubrication

Manual lubrication is accomplished by applying oil with a brush or spout can to the inside of the chain at the edges of the side plates. Volume and frequency should be determined by periodic inspection.

TYPE II—Drip Lubrication

Oil is directed between link plate edges to a drip lubricator. Only enough oil to keep the chain moist is necessary and a light metal splash guard will keep the floor and surroundings clean.

TYPE III—Bath or Disc Lubrication

With bath lubrication, the lower strand of the chain runs through a sump of oil. The oil level should reach the pitch line of the chain at its lowest point while operating. With disc lubrication, the chain operates above the oil level. The disc picks up oil from the sump and deposits it on the chain, usually by means of a trough. The disc diameter should be such as to produce rim speeds from 600 minimum to 8000 maximum FPM. This type of lubrication requires that the drive be enclosed in an oil tight chain case.

TYPE IV—Oil Stream Lubrication

The lubricant is usually supplied by a circulating pump capable of supplying the chain drive with a continuous stream of oil. The oil should be applied inside the chain loop evenly across the chain width, and directed at the lower strand. This type of lubrication requires that the drive be enclosed in an oil tight chain case.

Recommended lubricant viscosities for various ambient temperatures are listed in the following table:

Temp. Degrees F.	Lubricant	Temp. Degrees F.	Lubricant
20-40	SAE20	100-120	SAE-40
40-100	SAE30	120-140	SAE50

SURROUNDING CONDITIONS—Abrasive, corrosive, or high temperature conditions can shorten chain life. If adverse conditions exist, special precautions should be taken. It may be advisable to use a drive with higher capacity than normal, stainless steel chain, etc.

Roller chain drives may be selected with the following procedure:

- From Table #1 of the Application Classification Chart on Pages 331-332 determine the Service Factor.
- Multiply the Application HP by the Service Factor to obtain a Design HP.*
- The Selection Table below may be used to select an appropriate chain size using a sprocket of 17 teeth or larger.
- From the appropriate horsepower rating table (pages 268-270 determine the minimum size sprocket needed to provide, at the required speed, a rating equal to (or greater than) the Design horsepower.
- The Tables on pages 271-273 may then be used to select number of sprocket teeth, shaft center distance and chain length of a drive suitable for the application.

*For Stainless Steel Chains, operating under wet or dry conditions, the Design Horsepower must be multiplied by a Factor (see Table below) for selection purposes.

NOTE: Standard Steel Chains are not recommended for wet or dry applications.

Application Conditions	Factor
Wet (Moisture)	2.0
Dry (Unlubricated)	5.0

Horsepower ratings of Multiple Strand chain may be obtained by multiplying the Single Strand rating by the proper Factor from the following table:

MULTIPLE STRAND RATING FACTORS

Number of Strands	Double	Triple	Quadruple
Rating Factor	1.7	2.5	3.3

*These Horsepower Ratings are based on certain operating conditions, see Page 268.

SELECTION TABLE

RPM Smaller Sprocket	DESIGN HORSEPOWER												
	1/2	1	1-1/2	2	3	4	5	7-1/2	10	15	20	25	30
	CHAIN NUMBER												
1800	25	25	35	35	35	40	40	40	50	80	60-2	80-2	—
1500	25	25	35	35	35	40	40	40	60	60	80	60-2	80-2
1200	25	35	35	35	40	40	40	50	60	60	80	80	100
1000	25	35	35	35	40	40	40	50	60	60	80	80	80
800	25	35	35	40	40	40	40	50	60	60	80	80	80
700	25	35	35	40	40	50	50	50	60	80	80	80	80
600	35	35	35	40	40	50	50	60	60	80	80	80	100
500	35	35	40	40	50	50	50	60	80	80	80	100	100
400	35	35	40	40	50	50	50	60	80	80	100	100	100
350	35	40	40	40	50	50	50	60	80	80	100	100	100
300	35	40	40	50	50	60	60	80	80	100	100	100	120
250	35	40	40	50	50	60	60	80	80	100	100	120	120
200	35	40	50	50	60	60	60	80	80	100	120	120	120
175	40	40	50	50	60	60	80	80	100	100	120	120	140
150	40	50	50	60	60	80	80	80	100	120	120	120	140
125	40	50	50	60	80	80	80	100	100	120	120	140	140
100	40	50	60	60	80	80	80	100	100	120	140	140	160
80	40	50	60	80	80	80	100	100	120	140	140	160	160
70	50	60	60	80	80	80	100	100	120	140	160	160	
60	50	60	80	80	80	100	100	120	120	140	160		
50	50	60	80	80	80	100	100	120	140	160	160		
40	50	60	80	80	100	100	100	120	120	140	160		
30	60	80	80	100	100	120	120	140	140	160			
25	60	80	80	100	120	120	140	140	160				
20	60	80	100	100	120	120	140	140	160				
15	80	100	100	120	120	140	160						
10	80	100	120	120	140	140							

Roller Chain Drives

Horsepower Ratings for ANSI Roller Chains

See Horsepower Ratings, page 267

Small Sprocket		HP RATINGS—STANDARD SINGLE * STRAND ROLLER CHAIN—NO. 25-1/4" PITCH																										
RPM →	Teeth	P.D.	10	20	30	50	75	100	125	150	200	250	300	400	600	900	1200	1800	2500	3000	3500	4000						
	12	.97"	.007	.014	.020	.032	.046	.059	.072	.085	.11	.24	.16	.21	.29	0.43	0.55	0.80	1.07	1.26	1.45	1.62						
	15	1.20	.009	.018	.025	.040	.058	.075	.092	.108	.14	.17	.20	.26	.38	0.54	0.70	1.01	1.36	1.61	1.85	2.08						
	17	1.36	.011	.020	.029	.046	.066	.086	.105	.124	.16	.20	.23	.30	.43	0.62	0.81	1.16	1.56	1.84	2.11	2.38						
	19	1.52	.012	.023	.033	.052	.075	.097	.119	.140	.18	.22	.26	.34	.49	0.70	0.91	1.31	1.76	2.07	2.38	2.69						
	20	1.60	.013	.024	.035	.055	.079	.103	.125	.148	.19	.23	.28	.36	.52	0.74	0.96	1.38	1.86	2.19	2.52	2.84						
Lubrication #															Type I							Type II						

Small Sprocket		HP RATINGS—STANDARD SINGLE * STRAND ROLLER CHAIN—NO. 35-3/8" PITCH																										
RPM →	Teeth	P.D.	10	20	30	50	75	100	125	150	200	250	300	400	600	900	1200	1500	1800	2500	3000							
	11	1.33"	.023	.043	.062	.098	.14	.18	.22	.26	.34	.42	.49	.63	.91	1.32	1.72	2.08	2.47	3.32	2.93							
	13	1.57	.027	.051	.074	.117	.17	.22	.27	.31	.41	.50	.59	.76	1.09	1.59	2.05	2.49	2.96	3.98	3.76							
	15	1.80	.032	.060	.086	.136	.20	.26	.31	.37	.47	.58	.68	.89	1.28	1.85	2.40	2.91	3.45	4.64	4.66							
	17	2.04	.037	.068	.099	.156	.22	.29	.36	.42	.54	.66	.78	1.02	1.46	2.12	2.75	3.33	3.95	5.31	5.63							
	19	2.28	.042	.077	.111	.176	.25	.33	.40	.47	.61	.75	.88	1.15	1.65	2.39	3.10	3.76	4.46	5.99	6.65							
	21	2.52	.046	.086	.124	.196	.28	.37	.45	.53	.68	.83	.98	1.27	1.84	2.66	3.45	4.19	4.97	6.68	7.73							
	23	2.75	.051	.095	.137	.217	.31	.41	.49	.58	.75	.92	1.09	1.41	2.03	2.94	3.81	4.62	5.48	7.37	8.68							
	25	2.99	.055	.104	.150	.237	.34	.44	.54	.64	.82	1.01	1.19	1.54	2.22	3.21	4.16	5.06	6.00	8.06	9.50							
Lubrication #															Type I					Type II					Type III			

Small Sprocket		HP RATINGS—STANDARD SINGLE * STRAND ROLLER CHAIN—NO. 41-1/2" PITCH																										
RPM →	Teeth	P.D.	10	20	30	50	75	100	125	150	200	250	300	400	600	900	1200	1800	2400	3000								
	11	1.77"	.030	.056	.080	.13	.18	.24	.29	.34	.44	.54	.64	.82	1.19	1.71	1.71	.093	.060	.043								
	13	2.09	.036	.067	.096	.15	.22	.28	.35	.41	.53	.65	.76	.99	1.42	2.05	2.20	1.20	0.78	0.56								
	15	2.40	.042	.078	.112	.18	.26	.33	.40	.48	.62	.75	.89	1.15	1.66	2.39	2.73	1.49	0.96	0.69								
	17	2.72	.048	.089	.128	.20	.29	.38	.46	.55	.71	.86	1.02	1.32	1.90	2.74	3.29	1.79	1.16	0.83								
	19	3.04	.054	.100	.145	.23	.33	.43	.52	.62	.80	.97	1.15	1.49	2.14	3.09	3.89	2.12	1.38	0.98								
	21	3.35	.060	.112	.161	.26	.37	.48	.58	.69	.89	1.09	1.28	1.66	2.39	3.44	4.46	2.46	1.60	1.14								
	23	3.67	.066	.124	.178	.28	.41	.53	.64	.76	.98	1.20	1.41	1.83	2.64	3.79	4.92	2.82	1.83	1.31								
	25	3.99	.072	.135	.195	.31	.44	.58	.70	.83	1.07	1.31	1.55	2.00	2.88	4.15	5.38	3.20	2.08	1.49								
Lubrication #															Type I					Type II				Type III		Type IV		

Small Sprocket		HP RATINGS—STANDARD SINGLE * STRAND ROLLER CHAIN—NO. 43-1/2" PITCH																										
RPM →	Teeth	P.D.	10	20	30	40	50	75	100	125	150	175	200	250	300	350	400	500	600	900								
	11	1.77"	.030	.056	.080	.11	.13	.18	.24	.29	.34	.39	.44	.54	.64	.73	.82	1.01	1.19	1.40								
	13	2.09	.036	.067	.096	.13	.15	.22	.28	.35	.41	.47	.53	.65	.76	.87	.99	1.21	1.42	1.70								
	15	2.41	.042	.078	.112	.15	.18	.26	.33	.40	.48	.55	.62	.75	.89	1.02	1.15	1.41	1.66	2.00								
	16	2.56	.045	.084	.120	.16	.19	.28	.36	.43	.52	.59	.67	.81	.96	1.10	1.23	1.51	1.78	2.28								
	18	2.88	.051	.095	.137	.18	.22	.31	.41	.49	.59	.67	.76	.92	1.09	1.25	1.41	1.72	2.02	2.80								
	20	3.20	.057	.106	.153	.20	.25	.35	.46	.55	.66	.75	.85	1.03	1.22	1.40	1.58	1.93	2.27	3.25								
	22	3.51	.063	.118	.170	.23	.27	.39	.51	.61	.73	.83	.94	1.15	1.35	1.55	1.75	2.14	2.52	3.62								
	24	3.83	.069	.130	.187	.25	.30	.43	.56	.67	.80	.91	1.03	1.26	1.48	1.70	1.92	2.35	2.76	3.97								
Lubrication #															Type I					Type II					Type III			

*See Page 267 for Multiple Strand Rating Factor.

#See Page 267 for Lubrication Details.

RATINGS FOR INTERMEDIATE NUMBERS OF TEETH OR RPM MAY BE OBTAINED BY INTERPOLATION.

Roller Chain Drives

Horsepower Ratings for ANSI Roller Chains

See Horsepower Ratings, page 267

Small Sprocket		HP RATINGS—STANDARD SINGLE * STRAND ROLLER CHAIN—NO. 100-1-1/4" PITCH																		
RPM →	Teeth	10	20	30	50	75	100	125	150	200	250	300	400	500	600	900	1000	1200	1400	
	P.D.																			
	11	4.44	.81	1.51	2.18	3.45	4.97	6.44	7.88	9.28	12.0	14.7	17.3	22.4	27.4	32.3	27.5	23.4	17.8	14.2
	13	5.22	.97	1.81	2.61	4.13	5.96	7.72	9.43	11.1	14.4	17.6	20.7	26.9	32.8	38.7	35.3	30.1	22.9	18.2
	15	6.01	1.13	2.12	3.05	4.82	6.95	9.00	11.0	13.0	16.8	20.6	24.2	31.4	38.3	45.2	43.7	37.3	28.4	22.5
	17	6.80	1.30	2.42	3.49	5.52	7.96	10.3	12.6	14.9	19.2	23.5	27.7	35.9	43.9	51.7	52.7	45.0	34.3	27.2
	19	7.59	1.46	2.73	3.93	6.23	8.98	11.6	14.2	16.8	21.7	26.5	31.2	40.5	49.5	58.3	62.3	53.2	40.5	32.1
	21	8.39	1.63	3.04	4.38	6.94	10.0	12.9	15.8	18.7	24.2	29.6	34.8	45.1	55.1	64.9	72.4	61.8	47.0	37.3
	23	9.18	1.80	3.36	4.84	7.65	11.0	14.3	17.5	20.6	26.6	32.6	38.4	49.7	60.8	71.7	83.0	70.9	53.9	42.8
	25	9.97	1.97	3.67	5.29	8.37	12.1	15.6	19.1	22.5	29.2	35.7	42.0	54.4	66.5	78.4	94.1	80.3	61.1	48.5
Lubrication #		Type I			Type II			Type III					Type IV							

Small Sprocket		HP RATINGS—STANDARD SINGLE * STRAND ROLLER CHAIN—NO. 120-1-1/2" PITCH																			
RPM →	Teeth	10	20	30	50	75	100	125	150	200	250	300	400	500	600	700	800	900	1000	1200	
	P.D.																				
	11	5.324	1.37	2.56	3.68	5.82	8.40	10.9	13.3	15.6	20.3	24.8	29.2	37.8	46.3	54.5	46.3	37.9	31.8	27.1	20.6
	13	6.268	1.64	3.06	4.41	6.97	10.1	13.0	15.9	18.7	24.3	29.7	35.0	45.3	55.4	65.3	59.5	48.7	40.8	34.9	26.5
	15	7.215	1.91	3.57	5.14	8.13	11.7	15.2	18.6	21.9	28.3	34.7	40.8	52.9	64.6	76.1	73.8	60.4	50.6	43.2	32.9
	17	8.164	2.19	4.09	5.88	9.31	13.4	17.4	21.3	25.0	32.4	39.7	46.7	60.5	74.0	87.2	89.0	72.8	61.0	52.1	39.6
	19	9.114	2.47	4.61	6.64	10.5	15.2	19.6	24.0	28.2	36.5	44.8	52.7	68.2	83.4	98.3	105	86.1	72.1	61.6	46.8
	21	10.064	2.75	5.13	7.39	11.7	16.9	21.8	26.7	31.4	40.7	49.8	58.7	76.0	93.0	110	122	100	83.8	71.6	54.4
Lubrication #		Type I			Type II			Type III					Type IV								

Small Sprocket		HP RATINGS—STANDARD SINGLE * STRAND ROLLER CHAIN—NO. 140-1-3/4" PITCH																	
RPM →	Teeth	10	20	30	50	75	100	125	150	200	250	300	400	500	600	700	800	900	
	P.D.																		
	11	6.211	2.13	3.97	5.72	9.06	13.1	16.9	20.7	24.4	31.5	38.6	45.5	58.9	72.0	65.8	52.4	42.9	35.9
	13	7.312	2.55	4.74	6.83	10.9	15.6	20.3	24.7	29.2	37.8	46.2	54.4	70.5	86.2	84.6	67.3	55.1	46.2
	15	8.417	2.98	5.56	8.01	12.7	18.3	23.7	28.9	34.1	44.1	54.0	63.6	82.4	101	105	83.4	68.3	57.2
	17	9.523	3.41	6.36	9.16	14.5	20.9	27.1	33.1	39.0	50.5	61.7	72.8	94.2	115	126	100	82.4	69.1
	19	10.632	3.84	7.17	10.3	16.0	23.5	30.5	37.3	44.0	57.0	70.0	82.1	106	130	149	119	97.4	81.6
	21	11.742	4.28	7.98	11.5	18.2	26.2	34.0	41.5	49.0	63.4	77.6	91.4	118	145	171	138	113	94.8
Lubrication #		Type I			Type II			Type III					Type IV						

Small Sprocket		HP RATINGS—STANDARD SINGLE * STRAND ROLLER CHAIN—NO. 160-2" PITCH																
RPM →	Teeth	10	20	30	50	75	100	125	150	200	250	300	400	500	550	600		
	P.D.																	
	11	7.099	3.07	5.74	8.26	13.1	18.8	24.4	29.8	35.1	45.5	55.6	65.5	84.9	96.7	83.9	73.5	
	13	8.357	3.67	6.85	9.86	15.7	22.5	29.2	35.6	42.0	54.4	66.6	78.4	102	124	108	94.4	
	15	9.620	4.28	8.00	11.5	18.3	26.3	34.1	41.7	49.0	63.5	77.7	91.5	119	145	134	117	
	17	10.884	4.90	9.16	13.2	20.9	30.1	39.0	47.7	56.1	72.7	88.9	105	136	166	161	141	
	19	12.151	5.53	10.3	14.9	23.6	33.9	44.0	53.8	63.2	82.0	100	118	153	188	190	166	
	21	13.419	6.16	11.5	16.6	26.3	37.8	49.0	59.9	70.5	91.4	112	132	171	209	220	194	
Lubrication #		Type I			Type II			Type III					Type IV					

*See Page 267 for Multiple Strand Rating Factor.

#See Page 267 for Lubrication Details.

RATINGS FOR INTERMEDIATE NUMBERS OF TEETH OR RPM MAY BE OBTAINED BY INTERPOLATION.

SPEED RATIOS - CENTER DISTANCES - CHAIN LENGTHS

Teeth Driven Sprocket	Teeth on Driver Sprocket																			
	11	12	13	14	15	16	17	18	19	20	21	22	23	24	25					
15	1.36 6.469 26	1.25 7.235 28	1.15 6.993 28	1.07 7.748 20	1.00 7.500 30					RATIO CENTER DISTANCE - IN PITCHES CHAIN LENGTH - IN PITCHES To obtain corresponding values in INCHES, multiply by the appropriate Chain Pitch.										
16	1.45 7.207 28	1.33 6.971 28	1.23 7.736 30	1.14 7.494 30	1.07 8.249 32	1.00 8.000 32														
17	1.55 7.943 30	1.42 7.710 30	1.31 7.473 30	1.21 8.237 32	1.13 7.994 32	1.06 8.749 34	1.00 8.500 34													
18	1.64 7.669 30	1.50 8.446 32	1.38 8.212 32	1.29 7.975 32	1.20 8.737 34	1.13 8.495 34	1.06 9.249 36	1.00 9.000 36												
19	1.73 8.404 32	1.58 8.174 32	1.46 8.949 34	1.36 8.714 34	1.27 8.477 34	1.19 9.238 36	1.12 8.995 36	1.06 9.749 38	1.00 9.500 38											
20	1.82 8.124 32	1.67 8.909 34	1.54 8.679 34	1.43 9.452 36	1.33 9.216 36	1.25 8.978 36	1.18 9.739 38	1.11 9.495 38	1.05 10.249 40	1.00 10.000 40										
21	1.91 8.857 34	1.75 8.632 34	1.61 9.414 36	1.50 9.183 36	1.40 9.955 38	1.31 9.718 38	1.24 9.479 38	1.17 10.239 40	1.11 9.995 40	1.05 10.749 42	1.00 10.500 42									
22	2.00 9.590 36	1.83 9.365 36	1.69 9.139 36	1.57 9.918 38	1.47 9.686 38	1.37 10.457 40	1.29 10.220 40	1.22 9.980 40	1.16 10.740 42	1.10 10.496 42	1.05 11.249 44	1.00 11.000 44								
23	2.09 9.304 36	1.92 10.098 38	1.77 9.872 38	1.64 9.645 38	1.53 10.422 40	1.44 10.189 40	1.35 10.959 42	1.28 10.721 42	1.21 10.481 42	1.15 11.240 44	1.10 10.996 44	1.05 11.749 46	1.00 11.500 46							
24	2.18 10.037 38	2.00 9.815 38	1.85 10.605 40	1.72 10.378 40	1.69 10.150 40	1.50 10.926 42	1.41 10.692 42	1.33 11.461 44	1.26 11.222 44	1.20 10.982 44	1.14 11.741 46	1.09 11.496 46	1.04 12.249 48	1.00 12.000 48						
25	2.27 9.744 38	2.08 10.547 40	1.92 10.324 40	1.79 11.112 42	1.67 10.884 42	1.56 10.654 42	1.47 11.429 44	1.39 11.195 44	1.31 11.963 46	1.25 11.723 46	1.19 11.483 46	1.14 12.241 48	1.09 11.996 48	1.04 12.750 50	1.00 12.500 50					
30	2.72 11.345 44	2.50 12.161 46	2.31 11.943 46	2.14 12.746 48	2.00 12.522 48	1.88 12.299 48	1.76 13.087 50	1.67 12.858 50	1.58 13.638 52	1.50 13.406 52	1.43 13.172 52	1.36 13.942 54	1.30 13.705 54	1.25 14.469 56	1.20 14.228 56					
32	2.91 12.812 48	2.66 12.597 48	2.46 12.379 48	2.28 13.188 50	2.14 12.967 50	2.00 13.765 52	1.88 13.539 52	1.78 13.314 52	1.68 14.099 54	1.60 13.869 54	1.52 14.646 56	1.45 14.413 56	1.39 14.178 56	1.33 14.946 58	1.28 14.708 58					
35	3.18 13.976 52	2.92 13.761 52	2.69 13.546 52	2.50 14.361 54	2.33 14.141 54	2.19 13.921 54	2.06 14.721 56	1.94 14.497 56	1.84 15.288 58	1.75 15.061 58	1.67 14.833 58	1.59 15.613 60	1.52 15.382 60	1.46 16.155 62	1.40 15.921 62					
36	3.27 13.668 52	3.00 14.495 54	2.77 14.279 54	2.57 14.063 54	2.40 14.874 56	2.25 14.653 56	2.12 14.433 56	2.00 15.230 58	1.89 15.006 58	1.80 15.795 60	1.71 15.567 60	1.64 15.338 60	1.56 16.117 62	1.50 15.886 62	1.44 16.658 64					
40	3.64 15.561 58	3.34 15.349 58	3.08 15.136 58	2.86 15.961 60	2.67 15.746 60	2.50 15.528 60	2.35 16.339 62	2.22 16.119 62	2.10 16.920 64	2.00 16.697 64	1.90 16.473 64	1.82 17.262 66	1.74 17.035 66	1.67 17.818 68	1.60 17.588 68					
42	3.82 15.983 60	3.50 15.773 60	3.23 16.605 62	3.00 16.391 62	2.80 16.177 62	2.62 16.994 64	2.47 16.777 64	2.34 16.557 64	2.21 17.364 66	2.10 17.142 66	2.00 17.939 68	1.91 17.714 68	1.83 17.489 68	1.75 18.275 70	1.68 18.047 70					
45	4.09 17.139 64	3.75 16.930 64	3.46 16.719 64	3.22 17.553 66	3.00 17.340 66	2.81 18.161 68	2.65 17.945 68	2.50 17.728 68	2.37 18.536 70	2.25 18.317 70	2.14 18.096 70	2.04 18.895 72	1.96 18.671 72	1.88 19.463 74	1.80 19.237 74					

For Center Distances other than listed in this Table, the Chain Length must be calculated, see Page 273.



Roller Chain Drives

Selection

SPEED RATIOS - CENTER DISTANCES - CHAIN LENGTHS

Teeth Driven Sprocket	Teeth on Driver Sprocket														
	11	12	13	14	15	16	17	18	19	20	21	22	23	24	25
48	4.36 18.294 68	4.00 18.085 68	3.69 18.925 70	3.43 18.713 70	3.20 18.500 70	3.00 18.287 70	2.92 19.110 72	2.67 18.894 72	2.52 18.677 72	2.40 19.489 74	2.28 19.270 74	2.18 20.073 76	2.08 18.829 74	2.00 19.628 76	1.92 20.422 78
54	4.91 19.539 74	4.50 20.396 76	4.15 20.186 76	3.86 19.977 76	3.60 20.819 78	3.38 20.607 78	3.18 20.395 78	3.00 21.223 80	2.84 21.008 80	2.70 21.827 82	2.57 21.609 82	2.46 21.392 82	2.34 22.200 84	2.25 21.980 84	2.16 21.760 84
60	5.45 21.843 82	5.00 21.637 82	4.61 22.496 84	4.29 22.287 84	4.00 22.079 84	3.75 22.923 86	3.53 22.712 86	3.33 22.501 86	3.16 23.332 88	3.00 23.119 88	2.86 23.492 90	2.73 23.726 90	2.61 23.510 90	2.50 24.323 92	2.40 24.104 92
70		5.83 25.834 96	5.39 25.628 96	5.00 25.422 96	4.67 26.279 98	4.37 26.071 98	4.12 25.863 98	3.89 26.708 100	3.68 26.498 100	3.50 26.287 100	3.33 27.121 102	3.18 26.910 102	3.04 26.695 102	2.92 27.522 104	2.80 27.306 104
72		6.00 26.244 98	5.54 26.038 98	5.14 25.834 98	4.80 26.694 100	4.50 26.487 100	4.24 27.337 102	4.00 27.128 102	3.79 27.918 104	3.60 27.758 104	3.43 27.547 104	3.27 27.334 104	3.13 28.164 106	3.00 27.951 106	2.88 27.736 106
80				5.71 28.545 108	5.33 29.413 110	5.00 29.206 110	4.70 29.000 110	4.44 29.855 112	4.21 29.647 112	4.00 31.330 118	3.81 30.283 114	3.64 30.073 114	3.48 30.910 116	3.33 30.699 118	3.20 30.486 116
84				6.00 30.439 114	5.60 30.234 114	5.25 31.098 116	4.94 30.891 116	4.66 30.685 116	4.41 31.539 118	4.20 31.330 118	4.00 31.122 118	3.82 31.965 120	3.65 31.755 120	3.50 31.544 120	3.36 32.380 122
96						6.00 34.633 130	5.64 34.429 130	5.33 35.295 132	5.05 35.088 132	4.80 34.882 132	4.57 35.738 134	4.36 35.531 134	4.17 35.322 134	4.00 36.170 136	3.84 35.960 136
112									5.90 40.516 152	5.60 40.312 152	5.33 41.177 154	5.03 40.971 154	4.87 40.765 154	4.67 41.622 156	4.48 41.414 156

TO DETERMINE CHAIN LENGTH IN PITCHES
(Approximately):

$$L = 2C + \left(\frac{N + n}{2} \right) + \text{Constant}$$

Legend:

L = Chain length in pitches
C = Center distance in pitches
N = Number of teeth, driven
n = Number of teeth, driver

Constant:

If ratio is $\left\{ \begin{array}{l} \text{Up to 4:1} = 2 \\ \text{4 to 6:1} = 4 \\ \text{6 to 8:1} = 8 \end{array} \right.$

No. of Pitches	Chain Pitch — Inches											
	1/4	3/8	1/2	5/8	3/4	1	1-1/4	1-1/2	1-3/4	2	2-1/4	2-1/2
1	0.02	0.03	0.04	0.05	0.06	0.08	0.10	0.12	0.14	0.16	0.18	0.20
2	0.04	0.06	0.08	0.10	0.12	0.16	0.20	0.25	0.29	0.33	0.37	0.41
3	0.06	0.09	0.12	0.15	0.18	0.25	0.31	0.37	0.43	0.50	0.56	0.62
4	0.08	0.12	0.16	0.20	0.25	0.33	0.41	0.50	0.58	0.66	0.75	0.83
5	0.10	0.15	0.20	0.26	0.31	0.41	0.52	0.62	0.72	0.83	0.93	1.04
6	0.12	0.18	0.25	0.31	0.37	0.50	0.62	0.75	0.87	1.00	1.12	1.25
7	0.14	0.21	0.29	0.36	0.43	0.58	0.72	0.87	1.02	1.16	1.31	1.45
8	0.16	0.25	0.33	0.41	0.50	0.66	0.83	1.00	1.16	1.33	1.50	1.66
9	0.18	0.28	0.37	0.46	0.56	0.75	0.93	1.12	1.31	1.50	1.68	1.87
10	0.20	0.31	0.41	0.52	0.62	0.83	1.04	1.25	1.45	1.66	1.87	2.08
11	0.22	0.34	0.45	0.57	0.68	0.91	1.14	1.37	1.60	1.83	2.06	2.29
12	0.25	0.37	0.50	0.62	0.75	1.00	1.25	1.50	1.75	2.00	2.25	2.50
13	0.27	0.40	0.54	0.67	0.81	1.08	1.35	1.62	1.89	2.16	2.43	2.70
14	0.29	0.43	0.58	0.72	0.87	1.16	1.45	1.75	2.04	2.33	2.62	2.91
15	0.31	0.46	0.62	0.78	0.93	1.25	1.56	1.87	2.18	2.50	2.81	3.12
16	0.33	0.50	0.66	0.83	1.00	1.33	1.66	2.00	2.33	2.66	3.00	3.33
17	0.35	0.53	0.70	0.88	1.06	1.41	1.77	2.12	2.47	2.83	3.18	3.54
18	0.37	0.56	0.75	0.93	1.12	1.50	1.87	2.25	2.62	3.00	3.37	3.75
19	0.39	0.59	0.79	0.98	1.18	1.58	1.97	2.37	2.77	3.16	3.56	3.95
20	0.41	0.62	0.83	1.04	1.25	1.66	2.08	2.50	2.91	3.33	3.75	4.16
22	0.45	0.68	0.91	1.14	1.37	1.83	2.29	2.75	3.20	3.66	4.12	4.58
24	0.50	0.75	1.00	1.25	1.50	2.00	2.50	3.00	3.50	4.00	4.50	5.00
28	0.58	0.87	1.16	1.45	1.75	2.33	2.91	3.50	4.08	4.56	5.25	5.83
30	0.62	0.93	1.25	1.56	1.87	2.50	3.12	3.75	4.37	5.00	5.62	6.25
34	0.70	1.06	1.41	1.77	2.12	2.83	3.54	4.25	4.95	5.66	6.37	7.08
38	0.79	1.18	1.58	1.97	2.37	3.16	3.95	4.75	5.54	6.33	7.12	7.91
40	0.83	1.25	1.66	2.08	2.50	3.33	4.16	5.00	5.83	6.66	7.50	8.33
44	0.91	1.37	1.83	2.29	2.75	3.66	4.58	5.50	6.41	7.33	8.25	9.16
48	1.00	1.50	2.00	2.50	3.00	4.00	5.00	6.00	7.00	8.00	9.00	10.00
50	1.04	1.56	2.08	2.60	3.12	4.16	5.20	6.25	7.29	8.33	9.37	10.41
54	1.12	1.68	2.25	2.81	3.37	4.50	5.62	6.75	7.87	9.00	10.12	11.25
58	1.20	1.81	2.41	3.02	3.62	4.83	6.04	7.25	8.45	9.66	10.87	12.08
60	1.25	1.87	2.50	3.12	3.75	5.00	6.25	7.50	8.75	10.00	11.25	12.50
65	1.35	2.03	2.70	3.38	4.06	5.41	6.77	8.12	9.47	10.83	12.18	13.54
70	1.45	2.18	2.91	3.64	4.37	5.83	7.29	8.75	10.20	11.66	13.12	14.58
75	1.56	2.34	3.12	3.90	4.68	6.25	7.81	9.37	10.93	12.50	14.06	15.62
80	1.66	2.50	3.33	4.16	5.00	6.66	8.33	10.00	11.66	13.33	15.00	16.66
85	1.77	2.65	3.54	4.42	5.31	7.08	8.85	10.62	12.39	14.16	15.93	17.70
90	1.87	2.81	3.75	4.68	5.62	7.50	9.37	11.25	13.12	15.00	16.87	18.75
95	1.97	2.96	3.95	4.94	5.93	7.91	9.89	11.87	13.85	15.83	17.81	19.79
100	2.08	3.12	4.16	5.20	6.25	8.33	10.41	12.50	14.58	16.66	18.75	20.83

Miniature Chain Sprockets

Single Strand

.1475 Pitch; Plastic and Stainless Steel

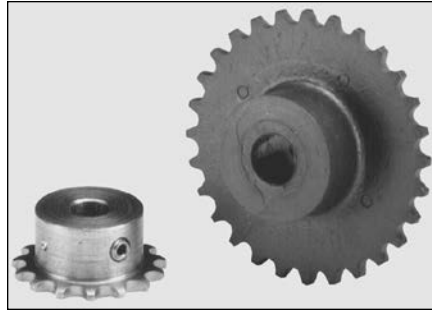

PLASTIC

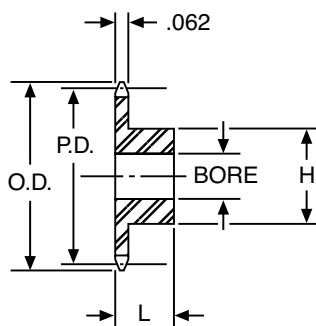

STAINLESS STEEL
7-28 TEETH

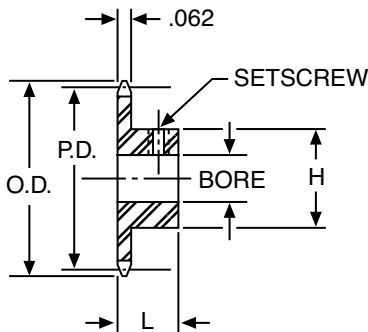

30-48 TEETH

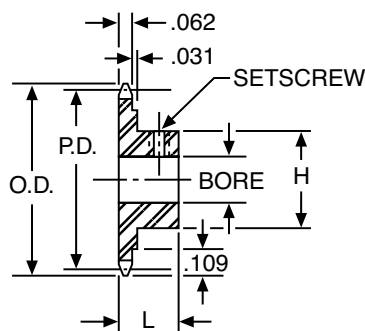

ALL DIMENSIONS IN INCHES
ORDER BY CATALOG NUMBER OR ITEM CODE

No. of Teeth	Pitch Dia.	Bore	Hub Dia.	O.D.	Length thru Bore	Catalog Number	Item Code
TYPE B SINGLE HUB PLASTIC (NYLATRON GS)							
7	.340	.093	3/16	.392	3/8	15BP7	54144
8	.385	.1250	7/32	.437		15BP8	54145
9	.431		1/4	.483		15BP9	54146
10	.477			.529		15BP10	54147
12	.570		.622	15BP12		54148	
13	.616	.1875	3/8	.668		15BP13	54149
14	.663			.715		15BP14	54150
15	.709		1/2	.761		15BP15	54151
16	.756			.808		15BP16	54152
17	.803			.855		15BP17	54153
18	.849			.901		15BP18	54154
19	.890		.948	15BP19		54155	
20	.943		.995	15BP20		54156	
21	.990	.250	5/8	1.042		15BP21	54157
22	1.036			1.088		15BP22	54158
23	1.083			1.135		15BP23	54159
24	1.130			1.182		15BP24	54160
25	1.177			1.228		15BP25	54161
26	1.224			1.276		15BP26	54162
27	1.270			1.322		15BP27	54163
28	1.317			1.369	15BP28	54164	
29	1.364			1.416	15BP29	54165	
30	1.411			1.463	15BP30	54166	
31	1.458	1.510	15BP31	54167			
32	1.505	1.557	15BP32	54168			
33	1.552	1.604	15BP33	54169			
34	1.598	1.650	15BP34	54170			
35	1.645	1.697	15BP35	54171			
36	1.692	1.744	15BP36	54172			
38	1.786	1.838	15BP38	54173			
40	1.880	1.922	15BP40	54174			
42	1.974	2.026	15BP42	54175			
44	2.068	2.120	15BP44	54176			
52	2.443	2.495	15BP52	54177			
TYPE B SINGLE HUB STAINLESS STEEL (TYPE 303 - CLEAR PASSIVATED)							
7	.340	.0937	15/64*	.392	11/32	15BSS7	54178
8	.385	.1250	9/32*	.437		15BSS8	54179
9	.431		21/64*	.483		15BSS9	54180
10	.477		3/8*	.529		15BSS10	54181
12	.570		25/64	.622		15BSS12	54182
15	.709	.1875	17/32	.761		15BSS15	54183
16	.756		9/16	.808		15BSS16	54184
18	.849		21/32	.901		15BSS18	54185
20	.943		.995	15BSS20		54186	
24	1.130	.2500	3/4	1.182		15BSS24	54187
28	1.317			1.369	15BSS28	54188	
30	1.411			1.463	15BSS30	54189	
34	1.598			1.650	15BSS34	54190	
36	1.692			1.744	15BSS36	54191	
40	1.880			1.932	15BSS40	54192	
48	2.255			2.307	15BSS48	54193	

STANDARD TOLERANCES*

DIMENSIONS		TOLERANCE
Bore	All	±.001 to -.000

*Stainless Steel Only.

Roller Chain Sprockets

Single Strand No. 25 1/4" Pitch; Steel

ORDER BY CATALOG NUMBER OR ITEM CODE

No. of Teeth	Pitch Dia.	Bore	Catalog Number	Item Code
TYPE A NO HUB STEEL				
32	2.551	3/8	25A32	68195
36	2.868		25A36	46224
40	3.186	1/2	25A40	46225
45	3.584		25A45	68198
48	3.822		25A48	46226
54	4.300		25A54	46227
60	4.777		25A60	46228
72	5.731		25A72	46229

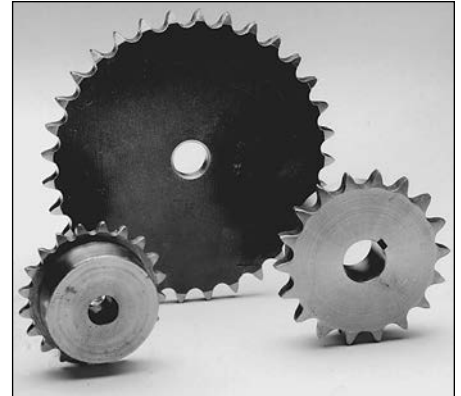

ORDER BY CATALOG NUMBER OR ITEM CODE

No. of Teeth	Pitch Dia.	Bore	Hub Dia.	Length thru Bore	With Setscrew*		Without Setscrew	
					Catalog Number	Item Code	Catalog Number	Item Code
TYPE B SINGLE HUB STEEL								
9	.731	1/4	29/64	1/2	25B9 - 1/4	68466	25B9	68465
10	.809	1/4	17/32	1/2	25B10 - 1/4	58230	25B10	15600
11	.887	1/4	9/16	1/2	25B11 - 1/4	68468	25B11	68467
12	.966	5/16	11/16	1/2	25B12 - 1/4	19200	25B12A	19199
					25B12 - 5/16	58231	25B12	15602
					25B12 - 3/8	58232	—	—
13	1.045	5/16	11/16	1/2	25B13 - 1/4	19202	25B13A	19201
					25B13 - 5/16	68470	25B13	15603
					25B13 - 3/8	68471	—	—
14	1.123	5/16	3/4	1/2	25B14 - 1/4	19204	25B14A	19203
					25B14 - 5/16	68473	25B14	68472
					25B14 - 3/8	68474	—	—
15	1.202	5/16	3/4	1/2	25B15 - 1/4	19206	25B15A	19205
					25B15 - 5/16	58233	25B15	15604
					25B15 - 3/8	58234	—	—
16	1.281	5/16	13/16	1/2	25B16 - 1/4	19208	25B16A	19207
					25B16 - 5/16	58235	25B16	15606
					25B16 - 3/8	58236	—	—
17	1.361	5/16	29/32	1/2	25B17 - 1/4	19210	25B17A	19209
					25B17 - 5/16	58237	25B17	15608
					25B17 - 3/8	58238	—	—
					25B17 - 1/2	58239	—	—
18	1.440	3/8	1	1/2	25B18 - 1/4	19212	25B18A	19211
					25B18 - 3/8	58240	25B18	15610
					25B18 - 1/2	58241	—	—
19	1.519	1/4	1-1/16	1/2	25B19 - 1/4	19214	25B19A	19213
					25B19 - 3/8	58242	25B19	15612
					25B19 - 1/2	58243	—	—
					25B19 - 5/8	58244	—	—
20	1.598	3/8	1-5/32	5/8	25B20 - 1/4	19216	25B20A	19215
					25B20 - 3/8	58245	25B20	15614
					25B20 - 1/2	58246	—	—
					25B20 - 5/8	58247	—	—
21	1.677	1/2	1-3/8	5/8	25B21 - 3/8	45670	25B21	68187
					25B21 - 1/2	45671	—	—
					25B21 - 5/8	45672	—	—
22	1.757	1/2	1-7/16	5/8	25B22 - 3/8	45673	25B22	68188
					25B22 - 1/2	45674	—	—
					25B22 - 5/8	45675	—	—
23	1.836	3/8	1-1/2	5/8	25B23 - 3/8	45676	25B23	68189
					25B23 - 1/2	45677	—	—
					25B23 - 5/8	45678	—	—
24	1.915	1/2	1-1/2	5/8	25B24 - 3/8	45679	25B24	68190
					25B24 - 1/2	45680	—	—
					25B24 - 5/8	45681	—	—

TYPE A

TYPE B

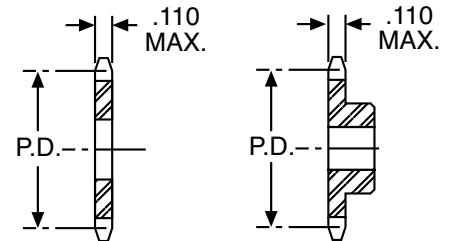

MAXIMUM DIA. OF CHAIN OVER SPROCKET = SPROCKET P.D. + .234"

STANDARD TOLERANCES

DIMENSION		TOLERANCE	
Type A	Bore	All	+ .002 - .001
Type B	Bore	All	± .001

Reference Pages

Alterations - 324
 Horsepower Ratings - 268-270
 Lubrication - 267
 Materials - 324
 Selection Procedure - 266
 ANSI Diameters - 325

*All sprockets have 10-32 setscrews.

Roller Chain Sprockets

Single Strand

No. 25 1/4" Pitch; Steel and Stainless Steel

ORDER BY CATALOG NUMBER OR ITEM CODE

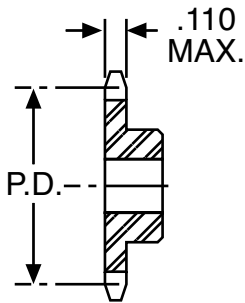
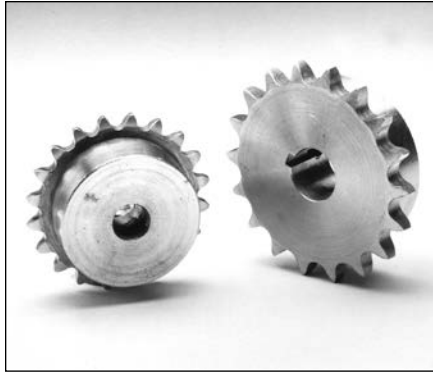

MAXIMUM DIA. OF CHAIN OVER SPROCKET = SPROCKET P.D. +.234"

STANDARD TOLERANCES

DIMENSIONS		TOLERANCE
Bore	All	±.001

Reference Pages

Alterations – 324
 Horsepower Ratings – 268-270
 Lubrication – 267
 Materials – 324
 Selection Procedure – 266
 ANSI Diameters – 325

*Sprockets 28 and 30 teeth have 10-32 set-screws. 32-72 teeth 1/4-20 setscrews.

No. of Teeth	Pitch Dia.	Bore	Hub Dia.	Length thru Bore	With Setscrew*		Without Setscrew				
					Catalog Number	Item Code	Catalog Number	Item Code			
TYPE B SINGLE HUB STEEL											
25	1.995	3/8	1-1/2	5/8	25B25 – 3/8	45682	25B25	68191			
		1/2			25B25 – 1/2	45683					
		5/8			25B25 – 5/8	45684					
26	2.074	3/8	1-1/2	5/8	25B26 – 3/8	45685	25B26	68192			
		1/2			25B26 – 1/2	45686					
		5/8			25B26 – 5/8	45687					
28	2.233	3/8	1-1/2	5/8	25B28 – 3/8	45692	25B28	68193			
		1/2			25B28 – 1/2	45693					
		5/8			25B28 – 5/8	45694					
30	2.392	3/8	1-9/32	1/2	25B30 – 3/8	58248	25B30	15616			
		1/2			25B30 – 1/2	58249					
		5/8			25B30 – 5/8	58250					
		3/4			25B30 – 3/4	58251					
32	2.551	1/2	1-1/2	5/8	25B32 – 1/2	67922	25B32	68204			
		5/8			25B32 – 5/8	45695					
		3/4			25B32 – 3/4	45696					
36	2.868	1/2	1-1/2	3/4	25B36 – 1/2	58252	25B36	15618			
		5/8			25B36 – 5/8	45709					
		3/4			25B36 – 3/4	45710					
40	3.186	1/2	2	3/4	25B40 – 1/2	58253	25B40	15620			
		5/8			25B40 – 5/8	45723					
		3/4			25B40 – 3/4	45724					
45	3.584	1/2	2	3/4	25B45 – 1/2	67925	25B45	68207			
		5/8			25B45 – 5/8	45725					
		3/4			25B45 – 3/4	45726					
48	3.822	1/2	2	3/4	25B48 – 1/2	58254	25B48	15622			
		5/8			25B48 – 5/8	45727					
		3/4			25B48 – 3/4	45728					
54	4.300	1/2	2	3/4	25B54 – 1/2	58255	25B54	15624			
		5/8			25B54 – 5/8	45729					
		3/4			25B54 – 3/4	45730					
60	4.777	1/2	2	3/4	25B60 – 1/2	58256	25B60	15626			
		5/8			25B60 – 5/8	45731					
		3/4			25B60 – 3/4	45732					
72	5.731	1/2	2	3/4	25B72 – 3/4	58257	25B72	15628			
		5/8			25B72 – 5/8	45739					
		3/4			25B72 – 3/4	45740					
TYPE B SINGLE HUB STAINLESS STEEL											
9	.731	1/4	7/16	1/2			25B9SS	69448			
10	.809	1/4	1/2				25B10SS	69449			
11	.887	1/4	9/16				25B11SS	69450			
12	.966	1/4	5/8				25B12SS	69451			
13	1.045	1/4	23/32				25B13SS	69452			
14	1.123	1/4	13/16				25B14SS	69453			
15	1.202	1/4	57/64				25B15SS	69456			
16	1.281	1/4	31/32				25B16SS	69467			
17	1.361	1/4	1-1/32				25B17SS	69468			
18	1.440	1/4	1-1/8				25B18SS	69469			
19	1.519	1/4	1-7/32				25B19SS	69470			
20	1.598	1/4	1-9/32				25B20SS	69471			
25	1.995	3/8	1-1/2				5/8			25B25SS	69472
30	2.392	3/8	1-1/2							25B30SS	69473
36	2.868	3/8	1-1/2							25B36SS	69474
40	3.186	1/2	2				3/4			25B40SS	69475
45	3.584	1/2	2							25B45SS	69476
60	4.777	1/2	2	25B60SS	69477						

Roller Chain Sprockets

Single Strand No. 35 3/8" Pitch; Steel

ORDER BY CATALOG NUMBER OR ITEM CODE

No. of Teeth	Pitch Dia.	Bore	Catalog Number	Item Code
TYPE A NO HUB STEEL				
26	3.111	1/2	35A26	67761
28	3.349		35A28	67763
30	3.588		35A30	67764
32	3.826	5/8	35A32	46230
36	4.303		35A36	46232
40	4.780	19/32	35A40	46233
45	5.376		35A45	46235
48	5.734		35A48	46236
72	8.597		35A72	67775

ORDER BY CATALOG NUMBER OR ITEM CODE

No. of Teeth	Pitch Dia.	Bore	Hub Dia.	Length thru Bore	With Keyway and Setscrew*		Without Keyway and Setscrew	
					Catalog Number	Item Code	Catalog Number	Item Code
TYPE B SINGLE HUB STEEL								
8	.980	3/8	3/4†	3/4	35B8 - 3/8*	49474	35B8	15630†
9	1.096	3/8	27/32†	3/4	35B9 - 3/8	45750	35B9	14882
10	1.214	3/8	31/32†	3/4	35B10 - 3/8	45751	35B10	14884
		1/2			35B10 - 1/2*	14886		
		5/8			35B10 - 5/8*	45752		
11	1.331	3/8	1-1/6†	3/4	35B11 - 3/8	45753	35B11	14888
		1/2			35B11 - 1/2	14890		
		5/8			35B11 - 5/8*	45754		
		3/4			35B11 - 3/4*	45755		
12	1.449	1/2	1-7/32†	3/4	35B12 - 1/2	14892	35B12	15632
		5/8			35B12 - 5/8*	14894		
		3/4			35B12 - 3/4*	14896		
13	1.567	1/2	1-1/4†	3/4	35B13 - 1/2	14898	35B13	15634
		5/8			35B13 - 5/8*	14900		
		3/4			35B13 - 3/4*	14902		
14	1.685	1/2	1-1/4	3/4	35B14 - 1/2	14904	35B14	15636
		5/8			35B14 - 5/8*	14906		
		3/4			35B14 - 3/4*	14908		
15	1.804	1/2	1-11/32	3/4	35B15 - 1/2	14910	35B15	15638
		5/8			35B15 - 5/8	14912		
		3/4			35B15 - 3/4*	14914		
16	1.922	1/2	1-15/32	3/4	35B16 - 1/2	14916	35B16	15640
		5/8			35B16 - 5/8	14918		
		3/4			35B16 - 3/4	14920		
17	2.041	1/2	1-19/32	3/4	35B17 - 1/2	14922	35B17	15642
		5/8			35B17 - 5/8	14924		
		3/4			35B17 - 3/4	14926		
		7/8			35B17 - 7/8	45756		
		1			35B17 - 1*	14928		
18	2.160	1/2	1-23/32	3/4	35B18 - 1/2	14930	35B18	15644
		5/8			35B18 - 5/8	14932		
		3/4			35B18 - 3/4	14934		
		7/8			35B18 - 7/8	46674		
		1			35B18 - 1	14936		
19	2.278	1/2	1-27/32	3/4	35B19 - 1/2	45757	35B19	15646
		5/8			35B19 - 5/8	14938		
		3/4			35B19 - 3/4	14940		
		1			35B19 - 1	14942		
20	2.397	1/2	1-15/16	3/4	35B20 - 1/2	45758	35B20	15648
		5/8			35B20 - 5/8	14944		
		3/4			35B20 - 3/4	14946		
		1			35B20 - 1	14948		
21	2.516	1/2	2	7/8	35B21 - 1/2	45759	35B21	15650
		5/8			35B21 - 5/8	14950		
		3/4			35B21 - 3/4	14952		
		1			35B21 - 1	14954		

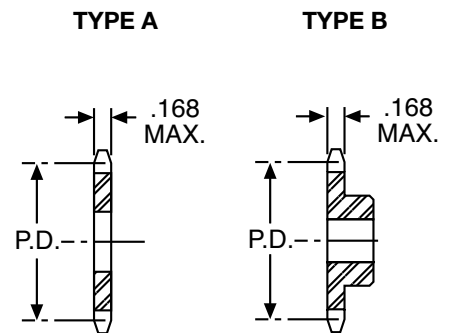
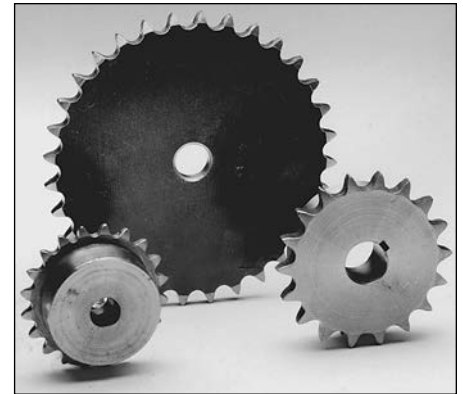

MAXIMUM DIA. OF CHAIN OVER SPROCKET = SPROCKET P.D. +.359"

STANDARD TOLERANCES

DIMENSION		TOLERANCE	
Type A	Bore	All	+ .002 - .001
Type B	Bore	All	±.001

Reference Pages

Alterations - 324
Horsepower Ratings - 268-270
Lubrication - 267
Materials - 324
Selection Procedure - 266
ANSI Diameters - 325

*All sprockets have standard keyway. All sprockets have 1/4-20 setscrews located over keyway, except at 90° where marked.

□Has recessed groove in hub for chain clearance.

Roller Chain Sprockets

Single Strand

No. 35 3/8" Pitch; Steel

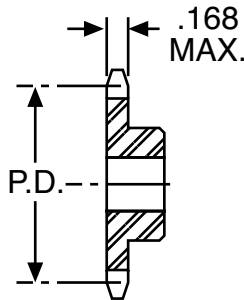
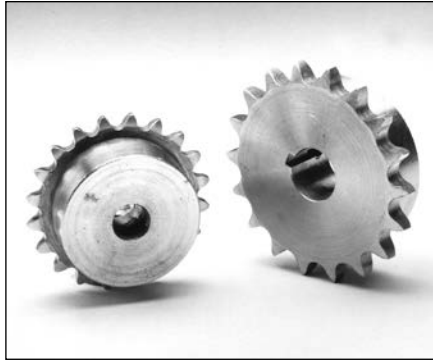

MAXIMUM DIA. OF CHAIN OVER SPROCKET = SPROCKET P.D. +.359"

STANDARD TOLERANCES

DIMENSIONS		TOLERANCE
Bore	All	±.001

Reference Pages

Alterations – 324
 Horsepower Ratings – 268-270
 Lubrication – 267
 Materials – 324
 Selection Procedure – 266
 ANSI Diameters – 325

*All sprockets have standard keyway. All sprockets have 1/4-20 setscrew located over keyway, except at 90° where marked.

ORDER BY CATALOG NUMBER OR ITEM CODE

No. of Teeth	Pitch Dia.	Bore	Hub Dia.	Length thru Bore	With Keyway and Setscrew*		Without Keyway and Setscrew	
					Catalog Number	Item Code	Catalog Number	Item Code
TYPE B SINGLE HUB STEEL								
22	2.635	1/2	2	7/8	35B22 – 1/2	45760	35B22	15652
		5/8			35B22 – 5/8	14956		
		3/4			35B22 – 3/4	14958		
		1			35B22 – 1	14960		
23	2.754	1/2	2	7/8	35B23 – 1/2	45761	35B23	15654
		5/8			35B23 – 5/8	14962		
		3/4			35B23 – 3/4	14964		
		1			35B23 – 1	14966		
24	2.873	1/2	2	7/8	35B24 – 1/2	45762	35B24	15656
		5/8			35B24 – 5/8	14968		
		3/4			35B24 – 3/4	14970		
		1			35B24 – 1	14972		
25	2.992	1/2	2	7/8	35B25 – 1/2	45763	35B25	15658
		5/8			35B25 – 5/8	14974		
		3/4			35B25 – 3/4	14976		
		1			35B25 – 1	14978		
26	3.111	1/2	2	7/8	35B26 – 1/2	45764	35B26	67808
		5/8			35B26 – 5/8	68257		
		3/4			35B26 – 3/4	68258		
		1			35B26 – 1	68259		
28	3.349	1/2	2	7/8	35B28 – 1/2	45766	35B28	67810
		5/8			35B28 – 5/8	68263		
		3/4			35B28 – 3/4	68264		
		1			35B28 – 1*	68265		
30	3.588	1/2	2	7/8	35B30 – 1/2	45767	35B30	15660
		5/8			35B30 – 5/8	68266		
		3/4			35B30 – 3/4	68267		
		1			35B30 – 1*	68268		
32	3.826	1/2	2	7/8	35B32 – 1/2	45768	35B32	15662
		5/8			35B32 – 5/8	68269		
		3/4			35B32 – 3/4	68270		
		1			35B32 – 1*	68271		
36	4.303	5/8	2-1/4	7/8	35B36 – 5/8	68275	35B36	15664
		3/4			35B36 – 3/4	68276		
		1			35B36 – 1*	68277		
		5/8			35B40 – 5/8	68278		
3/4	35B40 – 3/4	68279						
1	35B40 – 1	68280						
5/8	35B45 – 5/8	45772	35B45A	46241				
3/4	35B45 – 3/4	45773						
1	35B45 – 1	45774						
5/8	2-1/4	1			–	–	35B48	15668
54	6.449	5/8	2-1/4	1	–	–	35B54	15670
60	7.165	3/4	2-1/4	1	35B60 – 3/4	45782	35B60	15672
		1			35B60 – 1	45783		
72	8.597	3/4	2-1/4	1	–	–	35B72	15674
84	10.029	3/4	2-1/4	1	–	–	35B84	15676
96	11.461	3/4	2-1/4	1	–	–	35B96	15678
112	13.371	3/4	2-1/4	1	–	–	35B112	15680

Roller Chain Sprockets

Single Strand

No. 35 3/8" Pitch; Stainless Steel

ORDER BY CATALOG NUMBER OR ITEM CODE

No. of Teeth	Pitch Dia.	Bore	Hub Dia.	Length thru Bore	Without Keyway or Setscrew	
					Catalog Number	Item Code
TYPE A NO HUB STEEL						
9	1.096	3/8	27/32†	3/4	35B9SS	69478
10	1.214		31/32†		35B10SS	69479
11	1.331		1-1/16†		35B11SS	69480
12	1.449	1/2	1-7/32†	3/4	35B12SS	69481
13	1.567		1-1/4†		35B13SS	69482
14	1.685		1-1/4		35B14SS	69483
15	1.804		1-11/32		35B15SS	69484
16	1.922		1-15//32		35B16SS	69485
17	2.041		1-19/32		35B17SS	69486
18	2.160		1-23/32		35B18SS	69487
19	2.278		1-27/32		35B19SS	69488
20	2.397		1-15/16		35B20SS	69489
25	2.992	1/2	2	7/8	35B25SS	69490
30	3.588				35B30SS	69511
35	4.183	5/8	2-1/4	1	35B35SS	69512
40	4.780				35B40SS	69513
45	5.376				35B45SS	69624
60	7.165	3/4	2-1/4	1	35B60SS	69682

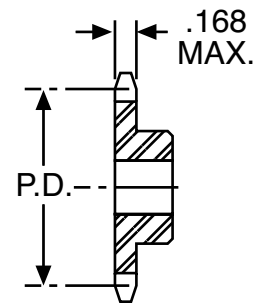
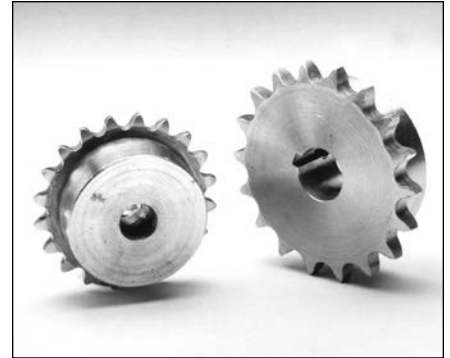

†Has recessed groove in hub for chain reference.

H

Double Strand

No. 35 3/8" Pitch; Stainless Steel

ORDER BY CATALOG NUMBER OR ITEM CODE

No. of Teeth	Pitch Dia.	Bore	Hub Dia.	Length thru Bore	Without Keyway or Setscrew	
					Catalog Number	Item Code
TYPE B SINGLE HUB STEEL						
16	1.922	1/2	1-15/32	1-1/4	D35B16	15930
17	2.041		1-19/32		D35B17	15932
18	2.160		1-23/32		D35B18	15934
19	2.278		1-7/8		D35B19	15936
20	2.397	3/4	1-15/16	1-3/8	D35B20	15938
21	2.516		2-1/16		D35B21	15940
22	2.635		2-3/16		D35B22	15942
23	2.754		2-1/4		D35B23	15944
24	2.873		2-1/4		D35B24	15946
25	2.992		2-1/4		D35B25	15948
30	3.588		3/4		2-1/2	1-3/8

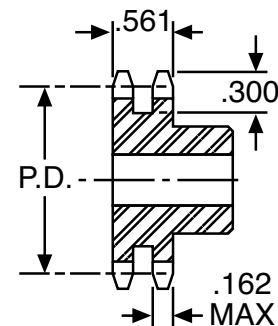

MAXIMUM DIA. OF CHAIN OVER SPROCKET = SPROCKET P.D. +.359"

STANDARD TOLERANCES

Stainless Steel		
Bore	All	+ .002 — .000
Double Strand		
Bore	All	±.001

Reference Pages

- Alterations – 324
- Horsepower Ratings – 268-270
- Lubrication – 267
- Materials – 324
- Selection Procedure – 266
- ANSI Diameters – 325

Roller Chain Sprockets

Single Strand

No. 41 1/2" Pitch; Steel

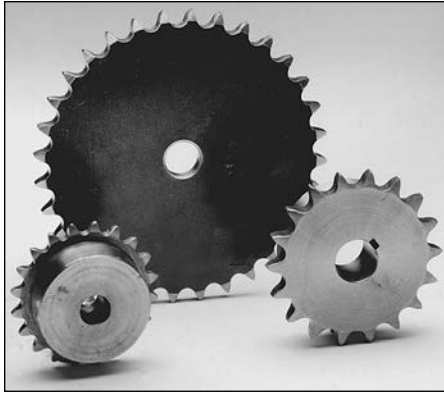

TYPE A

TYPE B

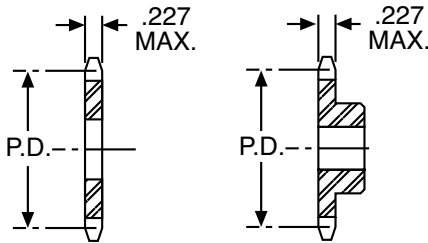

MAXIMUM DIA. OF CHAIN OVER SPROCKET = SPROCKET P.D. + .391"

STANDARD TOLERANCES

DIMENSIONS		TOLERANCE	
Type A	Bore	All	+ .002 - .001
Type B	Bore	All	± .001

Reference Pages

Alterations – 324
 Horsepower Ratings – 268-270
 Lubrication – 267
 Materials – 324
 Selection Procedure – 266
 ANSI Diameters – 325

*All sprockets have standard keyway. All sprockets have 1/4-20 setscrews located over keyway except at 90° where marked.

□ Has recessed groove in hub for chain clearance.

ORDER BY CATALOG NUMBER OR ITEM CODE

No. of Teeth	Pitch Dia.	Bore	Catalog Number	Item Code	
TYPE A – NO HUB STEEL					
21	3.355	5/8	41A21	56742	
22	3.513		41A22	56743	
23	3.672		41A23	56744	
24	3.831		41A24	56745	
25	3.989		41A25	56746	
26	4.148		41A26	67876	
27	4.307		41A27	67877	
28	4.466		41A28	67878	
30	4.783		41A30	16094	
32	5.101		19/32	41A32	16096
36	5.737	41A36		16098	
40	6.373	23/32	41A40	16100	
45	7.168		41A45	16102	
48	7.645		41A48	16104	
54	8.599		41A54	16106	
60	9.554		41A60	16108	
72	11.463		41A72	16112	
96	15.282		15/16	41A96	16116

ORDER BY CATALOG NUMBER OR ITEM CODE

No. of Teeth	Pitch Dia.	Bore	Hub Dia.	Length thru Bore	With Keyway and Setscrew*		Without Keyway and Setscrew	
					Catalog Number	Item Code	Catalog Number	Item Code
TYPE B SINGLE HUB STEEL								
6	1.000	3/8	21/32†	7/8	—	—	41B6	15758
7	1.15	3/8	3/4†	7/8	—	—	41B7	15760
8	1.307	1/2	63/64†	7/8	—	—	41B8	15762
9	1.462	1/2	1-1/8†	7/8	41B9-1/2	15506	41B9	15764
		5/8			41B9-5/8*	15508		
10	1.618	1/2	1-1/4†	7/8	41B10-1/2	15510	41B10	15766
		5/8			41B10-5/8*	15512		
		3/4			41B10-3/4*	15514		
11	1.775	1/2	1-7/16†	7/8	41B11-1/2	15516	41B11	15768
		5/8			41B11-5/8	15518		
		3/4			41B11-3/4*	15520		
12	1.932	1/2	1-9/16†	7/8	41B12-1/2	15522	41B12	15770
		5/8			41B12-5/8	15524		
		3/4			41B12-3/4	15526		
		7/8			41B12-7/8	35950		
13	2.089	1/2	1-9/16†	7/8	41B13-1/2	15528	41B13	15772
		5/8			41B13-5/8	15530		
		3/4			41B13-3/4	15532		
		7/8			41B13-7/8	35952		
		1			41B13-1*	15534		
14	2.247	1/2	1-3/4	7/8	41B14-1/2	15536	41B14	15774
		5/8			41B14-5/8	15538		
		3/4			41B14-3/4	15540		
		7/8			41B14-7/8	35954		
		1			41B14-1*	15542		
15	2.405	1/2	1-29/32	7/8	41B15-1/2	15544	41B15	15776
		5/8			41B15-5/8	15546		
		3/4			41B15-3/4	15548		
		1			41B15-1	15550		

Roller Chain Sprockets

Single Strand No. 41 1/2" Pitch; Steel

ORDER BY CATALOG NUMBER OR ITEM CODE

No. of Teeth	Pitch Dia.	Bore	Hub Dia.	Length thru Bore	With Keyway and Setscrew*		Without Keyway and Setscrew	
					Catalog Number	Item Code	Catalog Number	Item Code
TYPE B SINGLE HUB STEEL								
16	2.563	5/8	2-1/16	7/8	41B16-5/8	15552	41B16	15778
		3/4			41B16-3/4	15554		
		1			41B16-1	15556		
17	2.721	5/8	2-15/64	1	41B17-5/8	15558	41B17	15780
		3/4			41B17-3/4	15560		
		1			41B17-1	15562		
18	2.879	5/8	2-3/8	1	41B18-5/8	15564	41B18	15782
		3/4			41B18-3/4	15566		
		1			41B18-1	15568		
19	3.038	5/8	2-15/32	1	41B19-5/8	35956	41B19	15784
		3/4			41B19-3/4	15570		
		1			41B19-1	15572		
20	3.196	5/8	2-3/4	1	41B20-5/8	35958	41B20	15786
		3/4			41B20-3/4	15574		
		1			41B20-1	15576		
21	3.355	5/8	2-7/8	1	41B21-5/8	35960	41B21	15788
		3/4			41B21-3/4	15578		
		1			41B21-1	15580		
22	3.513	5/8	3	1	41B22-5/8	35962	41B22	15790
		3/4			41B22-3/4	15582		
		1			41B22-1	15584		
23	3.672	5/8	3-3/16	1	41B23-5/8	35964	41B23	15792
		3/4			41B23-3/4	15586		
		1			41B23-1	15588		
24	3.831	5/8	3-1/4	1	41B24-5/8	35966	41B24	15794
		3/4			41B24-3/4	15590		
		1			41B24-1	15592		
25	3.989	5/8	3-1/4	1	41B25-5/8	35968	41B25	15796
		3/4			41B25-3/4	15594		
		1			41B25-1	15596		
26	4.148	5/8	3-1/4	1	41B26-5/8	68281	41B26	67920
		3/4			41B26-3/4	68282		
		1			41B26-1	68283		
27	4.307	5/8	3-1/4	1	41B27-5/8	68284	41B27	67930
		3/4			41B27-3/4	68285		
		1			41B27-1	68286		
28	4.466	5/8	3-1/4	1	41B28-5/8	68287	41B28	67931
		3/4			41B28-3/4	68288		
		1			41B28-1	68289		
30	4.783	5/8	3-1/4	1	41B30-5/8	68290	41B30	16464
		3/4			41B30-3/4	68291		
		1			41B30-1	68292		
32	5.101	5/8	3-1/4	1	—	—	41B32	16466
36	5.737	5/8	3-1/4	1	—	—	41B36	16468
40	6.373	3/4	3-1/4	1-1/16	—	—	41B40	16470
45	7.168	3/4	3-1/2	1-1/16	—	—	41B45	16472
48	7.645	3/4	3-1/2	1-1/16	—	—	41B48	16474
54	8.599	3/4	3-1/2	1-1/16	—	—	41B54	16476
60	9.554	3/4	3-1/2	1-1/16	—	—	41B60	16478
72	11.463	3/4	4	1-3/16	—	—	41B72	16482
96	15.282	1	4	1-3/16	—	—	41B96	16486

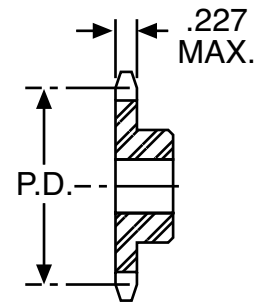
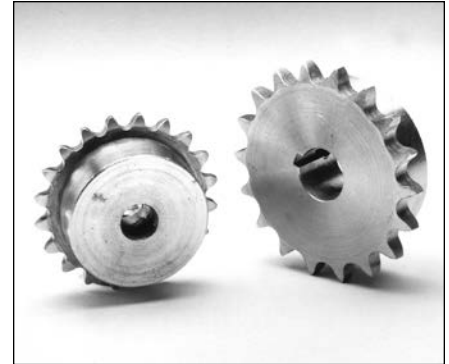

MAXIMUM DIA. OF CHAIN OVER SPROCKET = SPROCKET P.D. +.391"

STANDARD TOLERANCES

DIMENSION	TOLERANCE
Bore	All ±.001

Reference Pages

Alterations – 324
Horsepower Ratings – 268-270
Lubrication – 267
Materials – 324
Selection Procedure – 266
ANSI Diameters – 325

*All sprockets have standard keyways. All sprockets have 1/4-20 setscrews located over keyway.

Roller Chain Sprockets

Single Strand

No. 40 1/2" Pitch; Steel

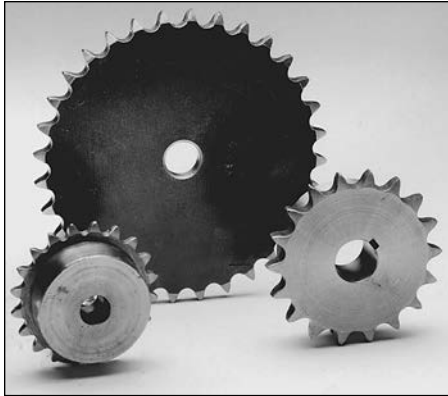

TYPE A

TYPE B

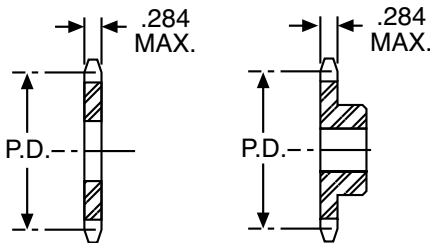

MAXIMUM DIA. OF CHAIN OVER SPROCKET = SPROCKET P.D. +.469"

STANDARD TOLERANCES

DIMENSIONS		TOLERANCE	
Type A	Bore	All	+ .002 - .001
Type B	Bore	All	± .001

Reference Pages

Alterations – 324
 Horsepower Ratings – 268-270
 Lubrication – 267
 Materials – 324
 Selection Procedure – 266
 ANSI Diameters – 325

*All sprockets have standard keyways. All sprockets have 1/4-20 setscrews, located over keyway, except at 90° where marked.

□ Has recessed groove in the hub for chain clearance.

ORDER BY CATALOG NUMBER OR ITEM CODE

No. of Teeth	Pitch Dia.	Bore	Catalog Number	Item Code
TYPE A—NO HUB STEEL				
19	3.038	5/8	40A19	68007
20	3.196		40A20	68008
21	3.355		40A21	56747
22	3.513		40A22	56748
23	3.672		40A23	56749
24	3.831		40A24	56750
25	3.989		40A25	56751
26	4.148		40A26	68014
27	4.307	40A27	68015	
28	4.466	40A28	68016	
30	4.783	19/32	40A30	16258
32	5.101		40A32	16260
35	5.578		40A35	68023
36	5.737		40A36	16262
38	6.055		40A38	68026
40	6.373	23/32	40A40	16264
42	6.691		40A42	16266
45	7.168		40A45	16268
48	7.645		40A48	16270
54	8.599		40A54	16272
60	9.554		40A60	16274
72	11.463		40A72	16278
84	13.372		40A84	16282
96	15.282	15/16	40A96	16284
112	17.828		40A112	16286

ORDER BY CATALOG NUMBER OR ITEM CODE

No. of Teeth	Pitch Dia.	Bore	Hub Dia.	Length thru Bore	With Keyway and Setscrew*		Without Keyway and Setscrew	
					Catalog Number	Item Code	Catalog Number	Item Code
TYPE B SINGLE HUB STEEL								
8	1.307	1/2	31/32†	7/8	—	—	40B8	15682
9	1.462	1/2	1-1/16†	7/8	40B9-1/2*	14980	40B9	15684
		5/8			40B9-5/8*	14982		
10	1.618	1/2	1-1/4†	7/8	40B10-1/2	14984	40B10	15686
		5/8			40B10-5/8*	14986		
		3/4			40B10-3/4*	14988		
11	1.775	1/2	1-3/8†	7/8	40B11-1/2	36054	40B11	15688
		5/8			40B11-5/8	14990		
		3/4			40B11-3/4	14992		
		7/8			40B11-7/8*	14994		
12	1.932	1/2	1-9/16†	7/8	40B12-1/2	36056	40B12	15690
		5/8			40B12-5/8	14996		
		3/4			40B12-3/4	14998		
		7/8			40B12-7/8	15000		
		1			40B12-1*	15002		
13	2.089	1/2	1-9/16	7/8	40B13-1/2	36058	40B13	15692
		5/8			40B13-5/8	15004		
		3/4			40B13-3/4	15006		
		7/8			40B13-7/8	15008		
		1			40B13-1*	15010		
14	2.247	1/2	1-11/16	7/8	40B14-1/2	36060	40B14	15694
		5/8			40B14-5/8	15012		
		3/4			40B14-3/4	15014		
		7/8			40B14-7/8	15016		
		1			40B14-1	15018		
		1-1/8			40B14-1-1/8*	56732		
15	2.405	1/2	1-13/16	7/8	40B15-1/2	36062	40B15	15696
		5/8			40B15-5/8	15020		
		3/4			40B15-3/4	15022		
		7/8			40B15-7/8	15024		
		1			40B15-1	15026		
		1-1/8			40B15-1-1/8	15028		
		1-3/16			40B15-1-3/16*	15030		
		1-1/4			40B15-1-1/4*	15032		

Roller Chain Sprockets

Single Strand No. 40 1/2" Pitch; Steel

ORDER BY CATALOG NUMBER OR ITEM CODE

No. of Teeth	Pitch Dia.	Bore	Hub Dia.	Length thru Bore	With Keyway and Setscrew*		Without Keyway and Setscrew	
					Catalog Number	Item Code	Catalog Number	Item Code
TYPE B SINGLE HUB STEEL								
16	2.563	5/8	2	7/8	40B16-5/8	15034	40B16	15698
		3/4			40B16-3/4	15036		
		7/8			40B16-7/8	15038		
		1			40B16-1	15040		
		1-1/8			40B16-1-1/8	36064		
		1-3/16			40B16-1-3/16	15042		
		1-1/4			40B16-1-1/4	15044		
17	2.721	5/8	2-1/8	1	40B17-5/8	15046	40B17	15700
		3/4			40B17-3/4	15048		
		7/8			40B17-7/8	36066		
		1			40B17-1	15050		
		1-1/8			40B17-1-1/8	15052		
		1-3/16			40B17-1-3/16	15054		
		1-1/4			40B17-1-1/4	56733		
18	2.879	5/8	2-5/16	1	40B18-5/8	36068	40B18	15702
		3/4			40B18-3/4	15056		
		7/8			40B18-7/8	15058		
		1			40B18-1	15060		
		1-1/8			40B18-1-1/8	15062		
		1-3/16			40B18-1-3/16	15064		
		1-1/4			40B18-1-1/4	15066		
		1-3/8			40B18-1-3/8	36070		
		1-7/16			40B18-1-7/16	15068		
		1-1/2			40B18-1-1/2	15070		
19	3.038	5/8	2-1/2	1	40B19-5/8	36072	40B19	15704
		3/4			40B19-3/4	15072		
		7/8			40B19-7/8	36074		
		1			40B19-1	15074		
		1-1/8			40B19-1-1/8	36076		
		1-3/16			40B19-1-3/16	15076		
		1-1/4			40B19-1-1/4	36078		
		1-3/8			40B19-1-3/8	36080		
		1-7/16			40B19-1-7/16*			
		1-1/2			40B19-1-1/2*	56734		
20	3.196	5/8	2-5/8	1	40B20-5/8	36082	40B20	15706
		3/4			40B20-3/4	15080		
		7/8			40B20-7/8	15082		
		1			40B20-1	15084		
		1-1/8			40B20-1-1/8	15086		
		1-3/16			40B20-1-3/16	15088		
		1-1/4			40B20-1-1/4	15090		
		1-3/8			40B20-1-3/8	36084		
		1-7/16			40B20-1-7/16	15092		
		1-1/2			40B20-1-1/2	15094		
21	3.355	5/8	2-3/4	1	40B21-5/8	36086	40B21	15708
		3/4			40B21-3/4	17148		
		7/8			40B21-7/8	15096		
		1			40B21-1	15098		
		1-1/8			40B21-1-1/8	36088		
		1-3/16			40B21-1-3/16	15100		
		1-1/4			40B21-1-1/4	36090		
		1-3/8			40B21-1-3/8	36092		
		1-7/16			40B21-1-7/16*			
		1-1/2			40B21-1-1/2*	15104		

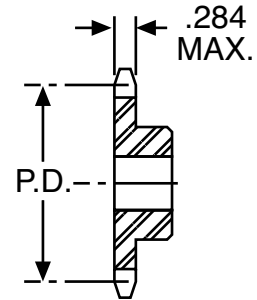
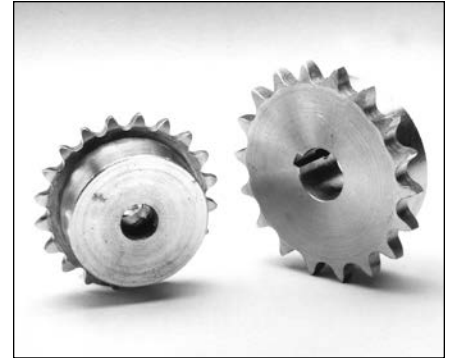

MAXIMUM DIA. OF CHAIN OVER SPROCKET = SPROCKET P.D. + .469"

STANDARD TOLERANCES

DIMENSION	TOLERANCE
Bore	All ±.001

Reference Pages

Alterations – 324
 Horsepower Ratings – 268-270
 Lubrication – 267
 Materials – 324
 Selection Procedure – 266
 ANSI Diameters – 325

*All sprockets have standard keyways. Sprockets 16-17 teeth have 1/4-20 setscrews, 18-21 teeth 5/16-18 setscrews, located over keyway, except at 90° where marked.

Roller Chain Sprockets

Single Strand

No. 40 1/2" Pitch; Steel

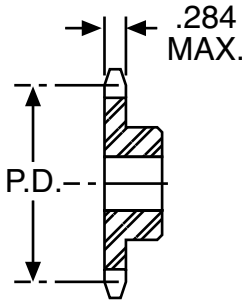
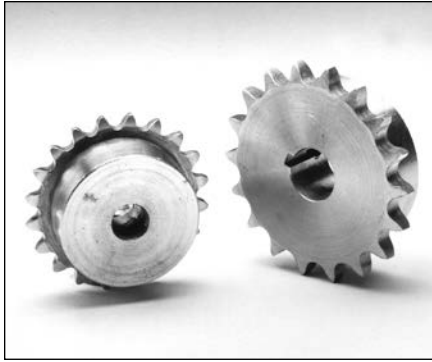

MAXIMUM DIA. OF CHAIN OVER SPROCKET = SPROCKET P.D. +.469"

STANDARD TOLERANCES

DIMENSIONS		TOLERANCE
Bore	All	±.001

Reference Pages

Alterations – 324
 Horsepower Ratings – 268-270
 Lubrication – 267
 Materials – 324
 Selection Procedure – 266
 ANSI Diameters – 325

*All sprockets have standard keyways. All sprockets have 5/16-18 setscrews located over keyway, except at 90° where marked.

ORDER BY CATALOG NUMBER OR ITEM CODE

No. of Teeth	Pitch Dia.	Bore	Hub Dia.	Length thru Bore	With Keyway and Setscrew*		Without Keyway and Setscrew	
					Catalog Number	Item Code	Catalog Number	Item Code
TYPE B SINGLE HUB STEEL								
22	3.513	5/8	2-7/8	1	40B22-5/8	36094	40B22	15710
		3/4			40B22-3/4	15106		
		7/8			40B22-7/8	36096		
		1			40B22-1	15108		
		1-1/8			40B22-1-1/8	15110		
		1-3/16			40B22-1-3/16	15112		
		1-1/4			40B22-1-1/4	15114		
		1-3/8			40B22-1-3/8	36098		
		1-7/16			40B22-1-7/16	15116		
		1-1/2			40B22-1-1/2	56735		
23	3.672	5/8	3	1	40B23-5/8	36102	40B23	15712
		3/4			40B23-3/4	15118		
		7/8			40B23-7/8	36104		
		1			40B23-1	15120		
		1-1/8			40B23-1-1/8	36106		
		1-3/16			40B23-1-3/16	15122		
		1-1/4			40B23-1-1/4	15124		
		1-3/8			40B23-1-3/8	36108		
		1-7/16			40B23-1-7/16	15126		
		1-1/2			40B23-1-1/2	56736		
24	3.831	5/8	3-1/4	1	40B24-5/8	36110	40B24	15714
		3/4			40B24-3/4	15128		
		7/8			40B24-7/8	36112		
		1			40B24-1	15130		
		1-1/8			40B24-1-1/8	15132		
		1-3/16			40B24-1-3/16	15134		
		1-1/4			40B24-1-1/4	15136		
		1-3/8			40B24-1-3/8	36114		
		1-7/16			40B24-1-7/16	15138		
		1-1/2			40B24-1-1/2	15140		
25	3.989	5/8	3-1/4	1	40B25-5/8	36116	40B25	15716
		3/4			40B25-3/4	15142		
		7/8			40B25-7/8	36118		
		1			40B25-1	15144		
		1-1/8			40B25-1-1/8	36120		
		1-3/16			40B25-1-3/16	36122		
		1-1/4			40B25-1-1/4	15146		
		1-7/16			40B25-1-7/16	36124		
		1-1/2			40B25-1-1/2	15148		
		26			4.148	5/8		
3/4	40B26-3/4		68293					
7/8	40B26-7/8		68294					
1	40B26-1		68295					
1-1/8	40B26-1-1/8		68296					
1-3/16	40B26-1-3/16		68297					
1-1/4	40B26-1-1/4		68298					
1-7/16	40B26-1-7/16		68299					
1-1/2	40B26-1-1/2		68300					
27	4.307		5/8	3-1/4		1	40B27-5/8	36128
		3/4	40B27-3/4		68301			
		7/8	40B27-7/8		68302			
		1	40B27-1		68303			
		1-1/8	40B27-1-1/8		68304			
		1-3/16	40B27-1-3/16		68305			
		1-1/4	40B27-1-1/4		68306			
		1-7/16	40B27-1-7/16		68307			
		1-1/2	40B27-1-1/2		68308			

Roller Chain Sprockets

Single Strand No. 40 1/2" Pitch; Steel

ORDER BY CATALOG NUMBER OR ITEM CODE

No. of Teeth	Pitch Dia.	Bore	Hub Dia.	Length thru Bore	With Keyway and Setscrew*		Without Keyway and Setscrew	
					Catalog Number	Item Code	Catalog Number	Item Code
TYPE B SINGLE HUB STEEL								
28	4.466	5/8	3-1/4	1	40B28-5/8	36130	40B28	68091
		3/4			40B28-3/4	68309		
		7/8			40B28-7/8	68310		
		1			40B28-1	68311		
		1-1/8			40B28-1-1/8	68312		
		1-3/16			40B28-1-3/16	68313		
		1-1/4			40B28-1-1/4	68314		
		1-7/16			40B28-1-7/16	68315		
		1-1/2			40B28-1-1/2	68316		
30	4.783	5/8	3-1/4	1	40B30-5/8	36134	40B30	16434
		3/4			40B30-3/4	68325		
		7/8			40B30-7/8	68326		
		1			40B30-1	68327		
		1-1/8			40B30-1-1/8	68328		
		1-3/16			40B30-1-3/16	68329		
		1-1/4			40B30-1-1/4	68330		
		1-7/16			40B30-1-7/16	68331		
		1-1/2			40B30-1-1/2	68332		
32	5.101	5/8	3-1/4	1	—	—	40B32	16436
35	5.578	5/8	3-1/4	1	40B35-5/8	36186	40B35	68096
		3/4			40B35-3/4	36188		
		1			40B35-1	36190		
		1-1/4			40B35-1-1/4	36192		
		1-7/16			40B35-1-7/16	36194		
		1-1/2			40B35-1-1/2	36196		
36	5.738	3/4	3-1/4	1	40B36-3/4	49478	40B36	16438
		1			40B36-1	36200		
		1-1/4			40B36-1-1/4	45979		
		1-7/16			40B36-1-7/16	45980		
		1-1/2			40B36-1-1/2	45981		
38	6.055	5/8	3-1/4	1	—	—	40B38	68098
40	6.373	3/4	3-1/2	1-1/8	—	—	40B40	16440
42	6.691	3/4	3-1/2	1-1/8	40B42-3/4	49479	40B42	16442
		1			40B42-1	36264		
		1-1/4			40B42-1-1/4	36266		
		1-7/16			40B42-1-7/16	36268		
		1-1/2			40B42-1-1/2	36270		
45	7.168	3/4	3-1/2	1-1/8	40B45-3/4	49480	40B45	16444
		1			40B45-1	36298		
		1-1/4			40B45-1-1/4	36300		
		1-7/16			40B45-1-7/16	36302		
		1-1/2			40B45-1-1/2	36304		
48	7.645	3/4	3-1/2	1-1/8	40B48-3/4	49481	40B48	16446
		1			40B48-1	36330		
		1-1/4			40B48-1-1/4	36332		
		1-7/16			40B48-1-7/16	36334		
		1-1/2			40B48-1-1/2	36336		
54	8.599	3/4	3-1/2	1-1/8	—	—	40B54	16448
60	9.554	1	3-1/2	1-1/8	40B60-1	36470	40B60	16450
		1-1/4			40B60-1-1/4	36472		
		1-7/16			40B60-1-7/16	36474		
		1-1/2			40B60-1-1/2	36476		
72	11.463	3/4	4	1-1/4	—	—	40B72	16454
84	13.372	3/4	4	1-1/4	—	—	40B84	16458
96	15.282	1	4	1-1/4	—	—	40B96	16460
112	17.828	1	4	1-1/4	—	—	40B112	16462

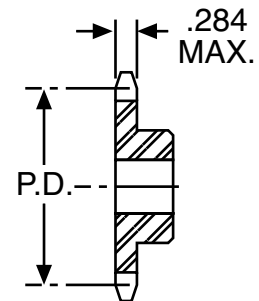
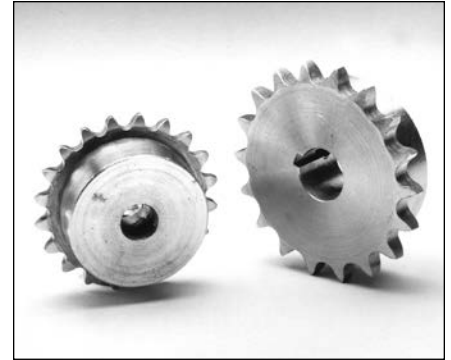

MAXIMUM DIA. OF CHAIN OVER SPROCKET = SPROCKET P.D. +.469"

STANDARD TOLERANCES

DIMENSION	TOLERANCE
Bore	All ±.001

Reference Pages

Alterations – 324
Horsepower Ratings – 268-270
Lubrication – 267
Materials – 324
Selection Procedure – 266
ANSI Diameters – 325

*All sprockets have standard keyways.
All sprockets have 5/16-18 setscrews located over keyway.

Roller Chain Sprockets

Single Strand

No. 40 1/2" Pitch; Stainless Steel

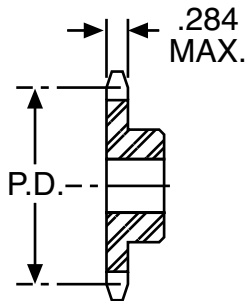
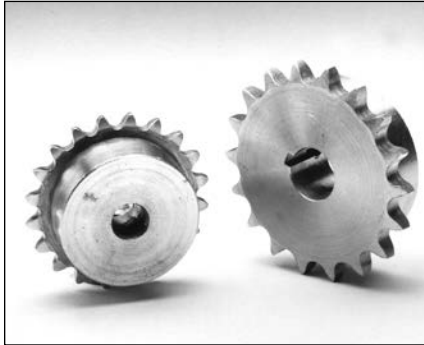

ORDER BY CATALOG NUMBER OR ITEM CODE

No. of Teeth	Pitch Dia.	Bore	Hub Dia.	Length thru	Without Keyway or Setscrew	
					Catalog Number	Item Code
TYPE B SINGLE HUB STAINLESS STEEL						
10	1.618	1/2	1-1/4†	7/8	40B10SS	69275
11	1.775		1-3/8†		40B11SS	69276
12	1.932		1-9/16†		40B12SS	69277
13	2.089		1-9/16		40B13SS	69278
14	2.247		1-11/16		40B14SS	69279
15	2.405	5/8	1-13/16	7/8	40B15SS	69280
16	2.563		2		40B16SS	69281
17	2.721	5/8	2-1/8	1	40B17SS	69282
18	2.879		2-5/16		40B18SS	69283
19	3.038		2-1/2		40B19SS	69294
20	3.196		2-5/8		40B20SS	69295
25	3.989		3-1/4		40B25SS	69296
30	4.783		3-1/4		40B30SS	69297
40	6.373	3/4	3-1/2	1	40B40SS	69300
45	7.168		3-1/2		40B45SS	69301
60	9.554		3-1/2		40B60SS	69302

†Has recessed groove in hub for chain reference.

H

Double Strand

No. 40 2-1/2" Pitch; Steel

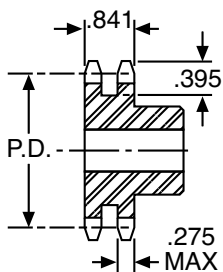

ORDER BY CATALOG NUMBER OR ITEM CODE

No. of Teeth	Pitch Dia.	Bore	Hub Dia.	Length thru	Without Keyway or Setscrew	
					Catalog Number	Item Code
TYPE B SINGLE HUB STEEL						
13	2.089	1/2	1-1/2	1-1/2	D40B13	46563
14	2.247		1-11/16		D40B14	46564
15	2.405		1-13/126		D40B15	46565
16	2.563	1/2	2	1-1/2	D40B16	15950
17	2.721		2-1/8		D40B17	15952
18	2.879		2-5/16		D40B18	15954
19	3.038		2-1/2		D40B19	15956
20	3.196		2-5/8		D40B20	15958
21	3.355	5/8	2-3/4	1-5/8	D40B21	15960
22	3.513		2-7/8		D40B22	15962
23	3.672		3		D40B23	15964
24	3.831		3-1/4		D40B24	15966
25	4.989		3-1/4		D40B25	15968
26	4.148		3-1/4		D40B26	68011
30	4.783	7/8	2-1/2	1-5/8	D40B30	68012
35	5.578		3-1/4		D40B35	68013
36	5.737	15/16	3-3/4	1-5/8	D40B36	68018
40	6.373		3-3/4		D40B40	68020

MAXIMUM DIA. OF CHAIN OVER SPROCKET = SPROCKET P.D. +.469"

STANDARD TOLERANCES

DIMENSIONS		TOLERANCE
Stainless Steel		
Bore	All	+ .002 - .000
Double Strand		
Bore	All	±.001

Reference Pages

Alterations – 324
 Horsepower Ratings – 268-270
 Lubrication – 267
 Materials – 324
 Selection Procedure – 266
 ANSI Diameters – 325

Roller Chain Sprockets

Single Strand No. 50 5/8" Pitch; Steel

ORDER BY CATALOG NUMBER OR ITEM CODE

No. of Teeth	Pitch Dia.	Bore	Catalog Number	Item Code
TYPE A NO HUB STEEL				
17	3.401	5/8	50A17	45865
18	3.599		50A18	56752
19	3.797		50A19	56753
20	3.955	3/4	50A20	56754
21	4.193		50A21	56755
22	4.392		50A22	56756
23	4.590		50A23	56757
24	4.788	23/32	50A24	56758
25	4.987		50A25	16288
26	5.185		50A26	45866
28	5.582		50A28	45867
30	5.979		50A30	16290
32	6.376		50A32	16292
35	6.872		50A35	45872
36	7.171		50A36	16294
40	7.966		50A40	16296
42	8.363		50A42	16298
45	8.960		50A45	16300
48	9.556		15/16	50A48
54	10.749	50A54		16304
60	11.942	50A60		16306
72	14.328	50A72		16310
84	16.715	50A84		16314
96	19.102	50A96		16316
112	21.885	50A112		16318

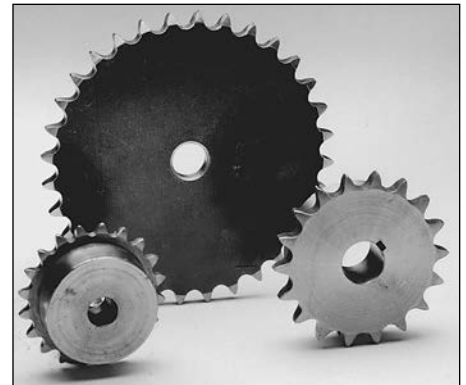

TYPE A

TYPE B

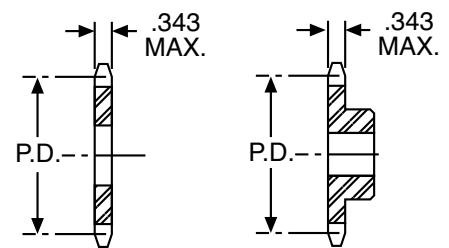

ORDER BY CATALOG NUMBER OR ITEM CODE

No. of Teeth	Pitch Dia.	Bore	Hub Dia.	Length thru Bore	With Keyway & Setscrew*		Without Keyway or Setscrew	
					Catalog Number	Item Code	Catalog Number	Item Code
TYPE B SINGLE HUB STEEL								
8	1.633	5/8	1-1/8†	1	50B8-5/8*	49482	50B8	15798
9	1.827	5/8	1-3/8†	1	50B9-5/8	15150	50B9	15800
		3/4			50B9-3/4*	15152		
10	2.023	5/8	1-9/16†	1	50B10-5/8	15154	50B10	15802
		3/4			50B10-3/4	15156		
		7/8			50B10-7/8	36496		
		1			50B10-1*	36498		
		5/8			50B11-5/8	15158	50B11	15804
11	2.218	3/4	1-3/4†	1	50B11-3/4	15160		
		7/8			50B11-7/8	15162		
		1			50B11-1*	15164		
		5/8			50B12-5/8	15166	50B12	15806
12	2.415	3/4	1-63/64†	1	50B12-3/4	15168		
		7/8			50B12-7/8	15170		
		1			50B12-1	15172		
		1-1/8			50B12-1-1/8	15174		
		1-3/16			50B12-1-3/16	36500		
		1-1/4			50B12-1-1/4*	36502		
		5/8			50B13-5/8	36504	50B13	15808
		3/4			50B13-3/4	15176		
13	2.612	7/8	1-7/8	1	50B13-7/8	15178		
		1			50B13-1	15180		
		1-1/8			50B13-1-1/8*	15182		
		1-3/16			50B13-1-3/16	15184		
		1-1/4			50B13-1-1/4*	15186		
		5/8			50B14-5/8	36506	50B14	15810
14	2.809	3/4	2-1/8	1	50B14-3/4	15188		
		7/8			50B14-7/8	15190		
		1			50B14-1	15192		
		1-1/8			50B14-1-1/8	15194		
		1-3/16			50B14-1-3/16	15196		
		1-1/4			50B14-1-1/4*	15198		

MAXIMUM DIA. OF CHAIN OVER SPROCKET = SPROCKET P.D. + .594"

STANDARD TOLERANCES

DIMENSION		TOLERANCE	
Type A	Bore	All	+0.002 - .001
Type B	Bore	All	±.001

Reference Pages

- Alterations – 324
- Horsepower Ratings – 268-270
- Lubrication – 267
- Materials – 324
- Selection Procedure – 266
- ANSI Diameters – 325

*All sprockets have standard keyway. Sprockets 8-12 teeth have 1/4-20 set-screw, 13-14 teeth 5/16-18 setscrew located over keyway except at 90° where marked.

†Has recessed groove in hub for chain clearance.

Roller Chain Sprockets

Single Strand

No. 50 5/8" Pitch; Steel

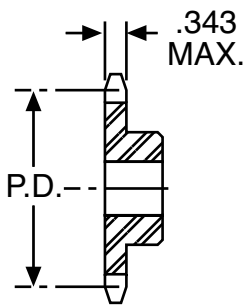
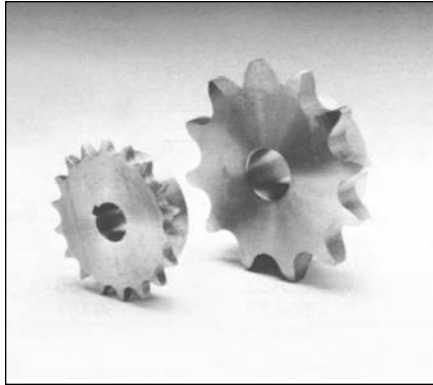

MAXIMUM DIA. OF CHAIN OVER SPROCKET = SPROCKET P.D. + .594"

STANDARD TOLERANCES

DIMENSIONS	TOLERANCE	
Bore	All	±.001

Reference Pages

Alterations – 324
 Horsepower Ratings – 268-270
 Lubrication – 267
 Materials – 324
 Selection Procedure – 266
 ANSI Diameters – 325

*All sprockets have standard keyway. All sprockets have 5/16–18 setscrews located over keyway except at 90° where marked.

ORDER BY CATALOG NUMBER OR ITEM CODE

No. of Teeth	Pitch Dia.	Bore	Hub Dia.	Length thru Bore	With Keyway & Setscrew*		Without Keyway or Setscrew	
					Catalog Number	Item Code	Catalog Number	Item Code
TYPE B SINGLE HUB STEEL								
15	3.006	5/8	2-3/8	1	50B15-5/8	36508	50B15	15812
		3/4			50B15-3/4	15200		
		7/8			50B15-7/8	15202		
		1			50B15-1	15204		
		1-1/8			50B15-1-1/8	36206		
		1-3/16			50B15-1-3/16	15208		
		1-1/4			50B15-1-1/4	15210		
		1-3/8			50B15-1-3/8	15212		
		1-7/16			50B15-1-7/16*	15214		
		1-1/2			50B15-1-1/2*	36510		
16	3.204	5/8	2-1/2	1	50B16-5/8	36512	50B16	15814
		3/4			50B16-3/4	15216		
		7/8			50B16-7/8	15218		
		1			50B16-1	15220		
		1-1/8			50B16-1-1/8	15222		
		1-3/16			50B16-1-3/16	15224		
		1-1/4			50B16-1-1/4	15226		
		1-3/8			50B16-1-3/8	15228		
		1-7/16			50B16-1-7/16	15230		
		1-1/2			50B16-1-1/2*	15232		
1-5/8	50B16-1-5/8*	36514						
17	3.401	5/8	2-11/16	1	50B17-5/8	36516	50B17	15816
		3/4			50B17-3/4	15234		
		7/8			50B17-7/8	17150		
		1			50B17-1	15236		
		1-1/8			50B17-1-1/8	15238		
		1-3/16			50B17-1-3/16	15240		
		1-1/4			50B17-1-1/4	15242		
		1-3/8			50B17-1-3/8*	15244		
		1-7/16			50B17-1-7/16*	15246		
		1-1/2			50B17-1-1/2*	56737		
1-5/8	50B17-1-5/8*	36518						
18	3.599	5/8	2-7/8	1	50B18-5/8	36520	50B18	15818
		3/4			50B18-3/4	15248		
		7/8			50B18-7/8	15250		
		1			50B18-1	15252		
		1-1/8			50B18-1-1/8	36522		
		1-3/16			50B18-1-3/16	15254		
		1-1/4			50B18-1-1/4	15256		
		1-3/8			50B18-1-1/4	15258		
		1-7/16			50B18-1-7/16	15260		
		1-1/2			50B18-1-1/2	15262		
19	3.797	5/8	3	1	50B19-5/8	36524	50B19	15820
		3/4			50B19-3/4	36526		
		7/8			50B19-7/8	36528		
		1			50B19-1	15264		
		1-1/8			50B19-1-1/8	15266		
		1-3/16			50B19-1-3/16	15268		
		1-1/4			50B19-1-1/4	15270		
		1-3/8			50B19-1-1/4	15272		
		1-7/16			50B19-1-7/16	15274		
		1-1/2			50B19-1-1/2	15276		
20	3.995	3/4	3	1	50B20-3/4	36530	50B20	15877
		7/8			50B20-7/8	15278		
		1			50B20-1	15280		
		1-1/8			50B20-1-1/8	56738		
		1-3/16			50B20-1-3/16	15282		
		1-1/4			50B20-1-1/4	15284		
		1-3/8			50B20-1-1/4	15286		
		1-7/16			50B20-1-7/16	15288		
		1-1/2			50B20-1-1/2	15290		
		1-5/8			50B20-1-5/8	36532		

Roller Chain Sprockets

Single Strand No. 50 5/8" Pitch; Steel

ORDER BY CATALOG NUMBER OR ITEM CODE

No. of Teeth	Pitch Dia.	Bore	Hub Dia.	Length thru Bore	With Keyway & Setscrew*		Without Keyway or Setscrew	
					Catalog Number	Item Code	Catalog Number	Item Code
TYPE B SINGLE HUB STEEL								
21	4.193	3/4	3	1	50B21-3/4	36536	50B21	15824
		1			50B21-1	15292		
		1-1/8			50B21-1-1/8	36540		
		1-3/16			50B21-1-3/16	36538		
		1-1/4			50B21-1-1/4	15294		
		1-3/8			50B21-1-3/8	36542		
		1-7/16			50B21-1-7/16	56739		
		1-1/2			50B21-1-1/2	15296		
22	4.392	3/4	3	1	50B22-3/4	36546	50B22	15826
		1			50B22-1	15300		
		1-1/8			50B22-1-1/8	36548		
		1-3/16			50B22-1-3/16	36550		
		1-1/4			50B22-1-1/4	15302		
		1-3/8			50B22-1-3/8	36552		
		1-7/16			50B22-1-7/16	36554		
		1-1/2			50B22-1-1/2	15304		
23	4.590	3/4	3	1	50B23-3/4	36558	50B23	15828
		1			50B23-1	15308		
		1-1/8			50B23-1-1/8	36560		
		1-3/16			50B23-1-3/16	36562		
		1-1/4			50B23-1-1/4	15310		
		1-3/8			50B23-1-3/8	36564		
		1-7/16			50B23-1-7/16	36566		
		1-1/2			50B23-1-1/2	15312		
24	4.788	3/4	3	1-1/4	50B24-3/4	36570	50B24	15830
		1			50B24-1	15316		
		1-1/8			50B24-1-1/8	36572		
		1-3/16			50B24-1-3/16	36574		
		1-1/4			50B24-1-1/4	15318		
		1-3/8			50B24-1-3/8	36576		
		1-7/16			50B24-1-7/16	36578		
		1-1/2			50B24-1-1/2	15320		
25	4.987	3/4	3	1-1/4	50B25-3/4	36582	50B25	15832
		1			50B25-1	36584		
		1-1/8			50B25-1-1/8	36586		
		1-3/16			50B25-1-3/16	36588		
		1-1/4			50B25-1-1/4	36590		
		1-3/8			50B25-1-3/8	36592		
		1-7/16			50B25-1-7/16	36594		
		1-1/2			50B25-1-1/2	36596		
26	5.185	3/4	3	1-1/4	50B26-3/4	36602	50B26	36598
		1			50B26-1	36604		
		1-1/8			50B26-1-1/8	36606		
		1-3/16			50B26-1-3/16	36608		
		1-1/4			50B26-1-1/4	36610		
		1-7/16			50B26-1-7/16	36612		
		1-1/2			50B26-1-1/2	36614		
		28			5.582	3/4		
1	50B28-1		36640					
1-1/8	50B28-1-1/8		36642					
1-3/16	50B28-1-3/16		36644					
1-1/4	50B28-1-1/4		36646					
1-7/16	50B28-1-7/16		36648					
1-1/2	50B28-1-1/2		36650					
30	5.979		3/4	3		1-1/4	50B30-3/4	36674
		1	50B30-1		36676			
		1-1/8	50B30-1-1/8		36678			
		1-3/16	50B30-1-3/16		36680			
		1-1/4	50B30-1-1/4		36682			
		1-7/16	50B30-1-7/16		36684			
		1-1/2	50B30-1-1/2		36686			

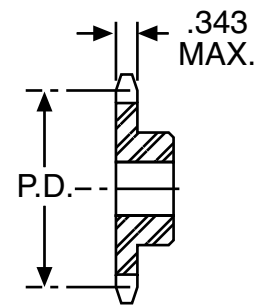
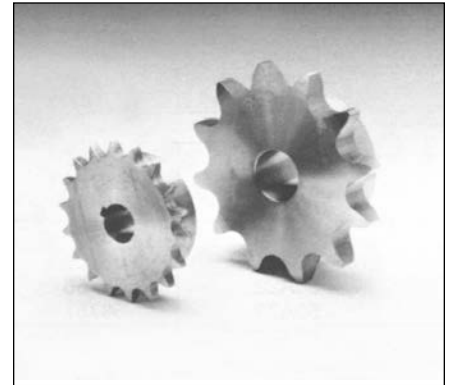

MAXIMUM DIA. OF CHAIN OVER SPROCKET = SPROCKET P.D. + .594"

STANDARD TOLERANCES

DIMENSION	TOLERANCE
Bore	All ±.001

Reference Pages

- Alterations – 324
- Horsepower Ratings – 268-270
- Lubrication – 267
- Materials – 324
- Selection Procedure – 266
- ANSI Diameters – 325

*All sprockets have standard keyway. All sprockets have 5/16–18 setscrews located over keyway except at 90° where marked.

Roller Chain Sprockets

Single Strand

No. 50 5/8" Pitch; Steel

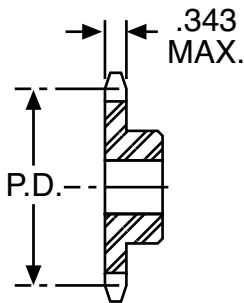
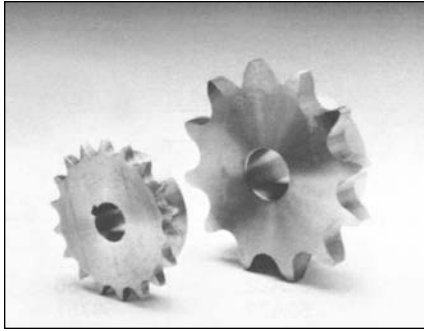

Reference Pages

Alterations – 324
 Horsepower Ratings – 268-270
 Lubrication – 267
 Materials – 324
 Selection Procedure – 266
 ANSI Diameters – 325

*All sprockets have standard keyway.
 All sprockets have 5/16–18 setscrews located over keyway except at 90° where marked.

ORDER BY CATALOG NUMBER OR ITEM CODE

No. of Teeth	Pitch Dia.	Bore	Hub Dia.	Length thru Bore	With Keyway & Setscrew*		Without Keyway or Setscrew	
					Catalog Number	Item Code	Catalog Number	Item Code
TYPE B SINGLE HUB STEEL								
32	6.376	3/4	3-1/4	1-1/4	—	—	50B32	16490
35	6.972	—	3-1/4	1-1/4	—	—	—	—
		3/4			50B35-3/4	36748	50B35	36744
		1			50B35-1	36750		
		1-1/4			50B35-1-1/4	36752		
		1-7/16			50B35-1-7/16	36754		
		1-1/2			50B35-1-1/2	36756		
36	7.171	3/4	3-1/4	1-1/4	—	—	50B36	16490
40	7.966	3/4	3-1/4	1-1/4	50B40-3/4	36808	50B40	16494
		1			50B40-1	36810		
		1-1/4			50B40-1-1/4	36812		
		1-7/16			50B40-1-7/16	36814		
		1-1/2			50B40-1-1/2	36816		
		1-15/16			50B40-1-15/16*	36818		
42	8.363	3/4	3-1/4	1-1/4	—	—	50B42	16496
45	8.960	3/4	3-3/4	1-1/4	50B45-3/4	36876	50B45	16498
		1			50B45-1	36878		
		1-1/4			50B45-1-1/4	36880		
		1-7/16			50B45-1-7/16	36882		
		1-1/2			50B45-1-1/2	36884		
		1-15/16			50B45-1-15/16*	36886		
48	9.556	1	3-3/4	1-1/4	50B48-1	36892	50B48	16500
		1-1/4			50B48-1-1/4	36894		
		1-7/16			50B48-1-7/16	36896		
		1-1/2			50B48-1-1/2	36898		
		1-15/16			50B48-1-15/16*	35942		
54	10.749	1	3-3/4	1-1/4	—	—	50B54	16502
60	11.942	1	3-3/4	1-1/4	50B60-1	35920	50B60	16504
		1-1/4			50B60-1-1/4	35922		
		1-7/16			50B60-1-7/16	35924		
		1-1/2			50B60-1-1/2	35926		
		1-15/16			50B60-1-15/16*	35928		
72	14.328	1	3-3/4	1-3/4	—	—	50B72	16508
84	16.715	1	4-1/4	1-3/4	—	—	50B84	16512
96	19.102	1	4-1/4	1-3/4	—	—	50B96	16514
112	21.885	1	4-1/4	1-3/4	—	—	50B112	16516

Double Strand

No. 50-2 5/8" Pitch; Steel

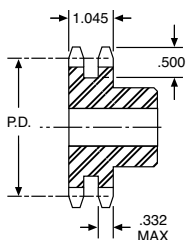

ORDER BY CATALOG NUMBER OR ITEM CODE

No. of Teeth	Pitch Dia.	Bore	Hub Dia.	Length thru Bore	With Keyway & Setscrew*	
					Catalog Number	Item Code
TYPE B SINGLE HUB STEEL						
15	3.006	3/4	2-5/16	1-3/4	D50B15	15970
16	3.204		2-1/2		D50B16	15972
17	3.401		2-11/16		D50B17	15974
18	3.599		2-15/16		D50B18	15976
20	3/995	1	3-1/4	1-3/4	D50B20	15980
21	4.193		3-1/2		D50B21	15982
22	4.392	1	3-9/16	1-7/8	D50B22	15984
24	4.788		3-5/8		D50B24	15988
25	4.987		3-5/8		D50B25	15990
30	5.979		3-3/4		D50B30	68166
40	7.966	1-3/16	4	2-1/8	D50B40	68173

STANDARD TOLERANCES

DIMENSIONS	TOLERANCE	
Bore	All	±.001

MAXIMUM DIA. OF CHAIN OVER SPROCKET = SPROCKET P.D. + .594"

Roller Chain Sprockets

Single Strand No. 60 3/4" Pitch; Steel

ORDER BY CATALOG NUMBER OR ITEM CODE

No. of Teeth	Pitch Dia.	Bore	Catalog Number	Item Code
TYPE A NO HUB STEEL				
17	4.082	3/4	60A17	56759
18	4.319		60A18	56760
19	4.557		60A19	56761
20	4.794		60A20	56762
21	5.032		60A21	16320
22	5.270		60A22	16322
23	5.508		60A23	16324
24	5.746	23/32	60A24	16326
25	5.984		60A25	16328
26	6.222		60A26	61894
28	6.699		60A28	46466
30	7.175		60A30	16330
32	7.652		60A32	16332
35	8.367	15/16	60A35	46471
36	8.605		60A36	16334
40	9.559		60A40	16336
45	10.752		60A45	16340
48	11.467		60A48	16342
54	12.899		60A54	16344
60	14.330		1-1/4	60A60
72	17.194	60A72		16350

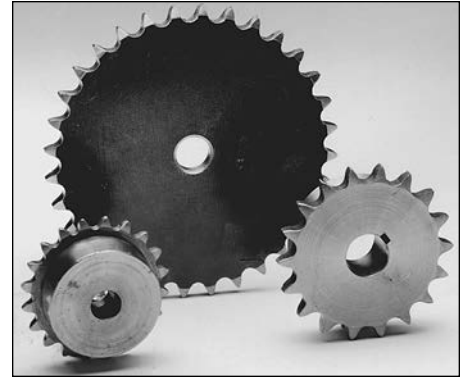

TYPE A

TYPE B

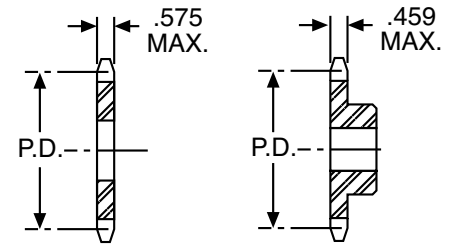

ORDER BY CATALOG NUMBER OR ITEM CODE

No. of Teeth	Pitch Dia.	Bore	Hub Dia.	Length thru Bore	With Keyway & Setscrew*		Without Keyway or Setscrew	
					Catalog Number	Item Code	Catalog Number	Item Code
TYPE B SINGLE HUB STEEL								
8	1.960	5/8	1-15/32†	1-1/4	60B8-3/4*	49483	60B8	15834
9	2.193	3/4	1-9/16†	1-1/4	60B9-3/4*	15324	60B9	15836
10	2.023	3/4	1-9/16†	1-1/4	60B10-3/4	15326	60B10	15838
		7/8			60B10-7/8	36180		
		1			60B10-1	15328		
		1-1/8			60B10-1-1/8*	36182		
		1-3/16			60B10-1-3/16*	36184		
11	2.662	3/4	2-1/16†	1-1/4	60B11-3/4	15334	60B11	15840
		7/8			60B11-7/8	36164		
		1			60B11-1	15332		
		1-1/8			60B11-1-1/8*	56740		
		1-3/16			60B11-1-3/16*	36494		
12	2.898	3/4	2-3/8†	1-1/4	60B12-3/4	15336	60B12	15842
		7/8			60B12-7/8	36616		
		1			60B12-1	15338		
		1-1/8			60B12-1-1/8	15340		
		1-3/16			60B12-1-3/16	15342		
13	3.134	3/4	2-11/32	1-1/4	60B13-3/4	15346	60B13	15844
		7/8			60B13-7/8	36620		
		1			60B13-1	15348		
		1-1/8			60B13-1-1/8	15350		
		1-3/16			60B13-1-3/16	15352		
14	3.370	3/4	2-9/16	1-1/4	60B14-3/4	15362	60B14	15846
		7/8			60B14-7/8	36144		
		1			60B14-1	15364		
		1-1/8			60B14-1-1/8	36146		
		1-3/16			60B14-1-3/16	15366		
	1-1/4	60B14-1-1/4	15368					
	1-3/8	60B14-1-3/8	15370					
	1-7/16	60B14-1-7/16	15372					
	1-1/2	60B14-1-1/2	15374					
	1-9/16	60B14-1-9/16*	36148					
	1-5/8	60B14-1-5/8*	36150					

MAXIMUM DIA. OF CHAIN OVER SPROCKET = SPROCKET P.D. + .703"

STANDARD TOLERANCES

DIMENSION		TOLERANCE	
Type A	Bore	All	+ .002 - .001
Type B	Bore	All	± .001

Reference Pages

Alterations – 324
Horsepower Ratings – 268-270
Lubrication – 267
Materials – 324
Selection Procedure – 266
ANSI Diameters – 325

*All sprockets have standard keyway. All sprockets have 1/4–20 setscrew, 9 to 12 tooth sprockets have 5/16–18 setscrew and 13 and 14 tooth sprockets have 3/8–16 setscrew, located over keyway except at 90° where marked.

†Has recessed groove in hub for chain clearance.

Roller Chain Sprockets

Single Strand

No. 60 3/4" Pitch; Steel

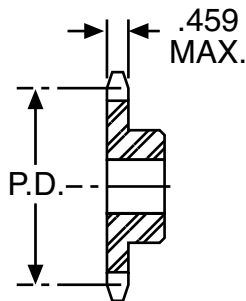
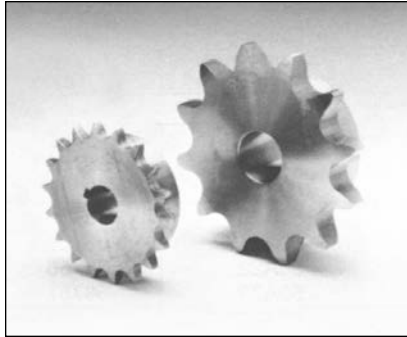

MAXIMUM DIA. OF CHAIN OVER SPROCKET = SPROCKET P.D. + .703"

STANDARD TOLERANCES

DIMENSIONS	TOLERANCE	
Bore	All	±.001

Reference Pages

Alterations – 324
 Horsepower Ratings – 268-270
 Lubrication – 267
 Materials – 324
 Selection Procedure – 266
 ANSI Diameters – 325

*All sprockets have standard keyway. All sprockets have 3/8–16 setscrew, located over keyway except at 90° where marked.

ORDER BY CATALOG NUMBER OR ITEM CODE

No. of Teeth	Pitch Dia.	Bore	Hub Dia.	Length thru Bore	With Keyway & Setscrew*		Without Keyway or Setscrew			
					Catalog Number	Item Code	Catalog Number	Item Code		
TYPE B SINGLE HUB STEEL										
15	3.607	3/4	2-7/8	1-1/4	60B15-3/4	36152	60B15	15848		
					60B15-7/8	36154				
					60B15-1	15376				
					60B15-1-1/8	36156				
					60B15-1-3/16	15378				
					60B15-1-1/4	15380				
					60B15-1-3/8	15382				
					60B15-1-7/16	15384				
					60B15-1-1/2	15386				
					60B15-1-9/16	36158				
					60B15-1-5/8	15388				
					60B15-1-3/4	15390				
					60B15-3/4	36160			60B16	15850
					60B16-7/8	36166				
60B16-1	15392									
60B16-1-1/8	36168									
60B16-1-3/16	15394									
60B16-1-1/4	15396									
60B16-1-3/8	15398									
60B16-1-7/16	15400									
60B16-1-1/2	15402									
60B16-1-9/16	36170									
60B16-1-5/8	15404									
60B16-1-3/4	36172									
60B16-1-15/16	15406									
17	4.082	3/4	3-1/4	1-1/4	60B17-3/4	49484	60B17	15852		
					60B17-1	15408				
					60B17-1-1/8	21782				
					60B17-1-3/16	21784				
					60B17-1-1/4	15410				
					60B17-1-3/8	21816				
					60B17-1-7/16	21818				
					60B17-1-1/2*	15412				
					60B17-1-9/16*	45666				
					60B17-1-5/8*	45667				
					60B17-1-3/4*	15414				
					60B18-3/4	49485			60B18	15854
					60B18-1	15416				
					60B18-1-1/8	21866				
60B18-1-3/16	21896									
60B18-1-1/4	15418									
60B18-1-3/8	21906									
60B18-1-7/16	21910									
60B18-1-1/2	15420									
60B18-1-9/16	21920									
60B18-1-5/8	21924									
60B18-1-3/4	15422									
19	4.557	3/4	3-1/2	1-1/4	60B19-3/4	21928	60B19	15856		
					60B19-1	15424				
					60B19-1-1/8	45656				
					60B19-1-3/16	46625				
					60B19-1-1/4	15426				
					60B19-1-3/8	45990				
					60B19-1-7/16	45657				
					60B19-1-1/2	15428				
					60B19-1-9/16	45658				
					60B19-1-5/8	45659				
					60B19-1-3/4	15430				
					60B19-1-15/16	45660				

Roller Chain Sprockets

Single Strand No. 60 3/4" Pitch; Steel

ORDER BY CATALOG NUMBER OR ITEM CODE

No. of Teeth	Pitch Dia.	Bore	Hub Dia.	Length thru Bore	With Keyway & Setscrew*		Without Keyway or Setscrew	
					Catalog Number	Item Code	Catalog Number	Item Code
TYPE B SINGLE HUB STEEL								
20	4.794	3/4	3-7/8	1-1/4	60B20-3/4	46576	60B20	15858
		1			60B20-1	17152		
		1-1/8			60B20-1-1/8	46577		
		1-3/16			60B20-1-3/16	45661		
		1-1/4			60B20-1-1/4	15432		
		1-3/8			60B20-1-3/8	46578		
		1-7/16			60B20-1-7/16	45662		
		1-1/2			60B20-1-1/2	15434		
		1-9/16			60B20-1-9/16	45663		
		1-5/8			60B20-1-5/8	45664		
		1-3/4			60B20-1-3/4	15436		
		1-15/16			60B20-1-15/16	46579		
21	5.032	3/4	4	1-1/4	60B21-3/4	20034	60B21	15860
		1			60B21-1	20040		
		1-1/4			60B21-1-1/4	20132		
		1-7/16			60B21-1-7/16	20142		
		1-1/2			60B21-1-1/2	20846		
1-15/16	60B21-1-15/16	20858						
22	5.270	3/4	4	1-1/4	60B22-3/4	21550	60B22	15862
		1			60B22-1	21570		
		1-1/4			60B22-1-1/4	45669		
		1-7/16			60B22-1-7/16	45688		
		1-1/2			60B22-1-1/2	45689		
		1-15/16			60B22-1-15/16	45690		
23	5.508	3/4	4	1-1/4	60B23-3/4	45744	60B23	15864
		1			60B23-1	45691		
		1-1/4			60B23-1-1/4	45698		
		1-7/16			60B23-1-7/16	45699		
		1-1/2			60B23-1-1/2	45700		
		1-15/16			60B23-1-15/16	45702		
24	5.746	3/4	4	1-1/4	60B24-3/4	36020	60B24	15866
		1			60B24-1	45703		
		1-1/4			60B24-1-1/4	45704		
		1-7/16			60B24-1-7/16	45705		
		1-1/2			60B24-1-1/2	45706		
		1-15/16			60B24-1-15/16	45707		
25	5.984	3/4	4	1-1/4	60B25-3/4	36022	60B25	15868
		1			60B25-1	45745		
		1-1/4			60B25-1-1/4	45711		
		1-7/16			60B25-1-7/16	45712		
		1-1/2			60B25-1-1/2	45713		
		1-15/16			60B25-1-15/16	45714		
26	6.222	3/4	4	1-1/4	60B26-3/4	36024	60B26	45747
		1			60B26-1	45746		
		1-1/4			60B26-1-1/4	45715		
		1-7/16			60B26-1-7/16	45716		
		1-1/2			60B26-1-1/2	45717		
		1-15/16			60B26-1-15/16	45718		
28	6.699	3/4	4	1-1/4	60B28-3/4	36030	60B28	45720
		1			60B28-1	45721		
		1-1/4			60B28-1-1/4	45722		
		1-7/16			60B28-1-7/16	45734		
		1-1/2			60B28-1-1/2	45735		
		1-15/16			60B28-1-15/16	45736		
30	7.175	3/4	4	1-1/4	60B30-3/4	36036	60B30	16518
		1			60B30-1	45738		
		1-1/4			60B30-1-1/4	45749		
		1-7/16			60B30-1-7/16	45765		
		1-1/2			60B30-1-1/2	45795		
		1-15/16			60B30-1-15/16	45775		

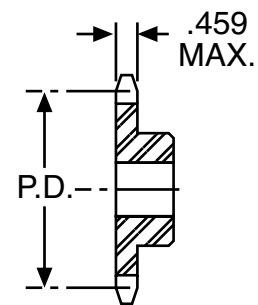
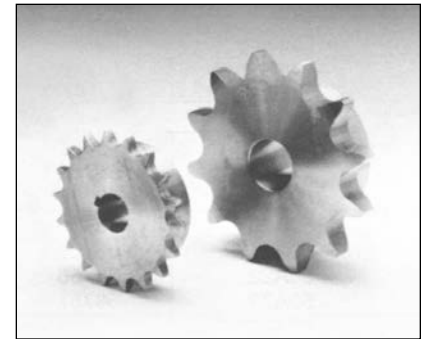

MAXIMUM DIA. OF CHAIN OVER SPROCKET = SPROCKET P.D. + .703"

STANDARD TOLERANCES

DIMENSION	TOLERANCE
Bore	All ±.001

Reference Pages

Alterations – 324
 Horsepower Ratings – 268-270
 Lubrication – 267
 Materials – 324
 Selection Procedure – 266
 ANSI Diameters – 325

*All sprockets have standard keyway. All sprockets have 3/8–16 setscrew, located over keyway except at 90° where marked.

Roller Chain Sprockets

Single Strand

No. 60 3/4" Pitch; Steel

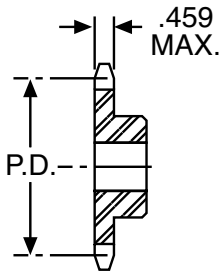
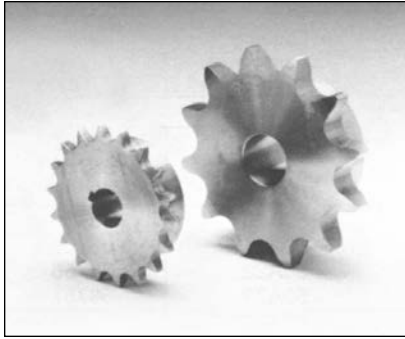

Reference Pages

- Alterations – 324
- Horsepower Ratings – 268-270
- Lubrication – 267
- Materials – 324
- Selection Procedure – 266
- ANSI Diameters – 325

*All sprockets have standard keyway. All sprockets have 3/8-16 setscrew, located over keyway.

ORDER BY CATALOG NUMBER OR ITEM CODE

No. of Teeth	Pitch Dia.	Bore	Hub Dia.	Length thru Bore	With Keyway & Setscrew*		Without Keyway or Setscrew	
					Catalog Number	Item Code	Catalog Number	Item Code
TYPE B SINGLE HUB STEEL								
32	7.652	3/4	4	1-1/4	60B32-3/4	49486	60B32	16520
		1			60B32-1	49847		
		1-1/4			60B32-1-1/4	49488		
		1-7/16			60B32-1-7/16	49489		
		1-1/2			60B32-1-1/2	49490		
		1-15/16			60B32-1-15/16	49491		
35	8.367	—	4	1-1/4	—	—	60B35	45778
		1			60B35-1	45779		
		1-1/4			60B35-1-1/4	45780		
		1-7/16			60B35-1-7/16	45793		
		1-1/2			60B35-1-1/2	45784		
		1-15/16			60B35-1-15/16	45796		
36	8.605	1	4	1-1/4	—	—	60B36	16522
40	9.559	1-3/16	4-1/4	1-1/4	60B40-1-3/16	45843	60B40	16524
		1-1/4			60B40-1-1/4	45844		
		1-7/16			60B40-1-7/16	45845		
		1-1/2			60B40-1-1/2	45846		
		1-15/16			60B40-1-15/16	45848		
		2-7/16			60B40-2-7/16	45849		
45	10.752	1-3/16	4-1/4	1-1/4	60B45-1-3/16	61668	60B45	16528
		1-1/4			60B45-1-1/4	61673		
		1-7/16			60B45-1-7/16	46463		
		1-1/2			60B45-1-1/2	61677		
		1-15/16			60B45-1-15/16	61679		
		2-7/16			60B45-2-7/16	61680		
48	11.467	1-3/16	4-1/4	1-1/4	—	—	60B48	16530
54	12.899	1-3/16	4-1/4	1-3/4	—	—	60B54	16532
60	14.330	1-3/16	4-1/4	1-3/4	—	—	60B60	16534
		1-7/16			60B60-1-7/16	46464		
		1-1/2			60B60-1-1/2	46465		
		1-15/16			60B60-1-15/16	61869		
		2-7/16			60B60-2-7/16	61870		
72	17.194	1-1/4	4-1/4	2	—	—	60B72	16538

Double Strand

No. 60 2-3/4" Pitch; Steel

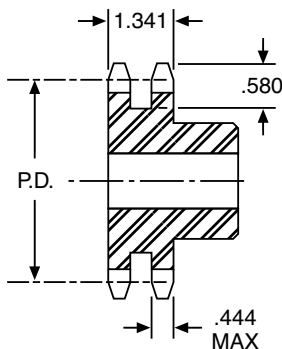

ORDER BY CATALOG NUMBER OR ITEM CODE

No. of Teeth	Pitch Dia.	Bore	Hub Dia.	Length thru Bore	Without Keyway & Setscrew*	
					Catalog Number	Item Code
TYPE B SINGLE HUB STEEL						
15	3.607	1	2-13/16	2-1/8	D60B15	15992
16	3.844		3		D60B16	15994
17	4.082		3-1/4		D60B17	15996
18	4.319		3-1/2		D60B18	15998
19	4.557		3-11/16		D60B19	16000
20	4.794		3-3/4		D60B20	16002
21	5.032		4-1/8		D60B21	16004
25	5.984		4-1/4		D60B25	16006

STANDARD TOLERANCES

DIMENSIONS	TOLERANCE	
Bore	All	±.001

MAXIMUM DIA. OF CHAIN OVER SPROCKET = SPROCKET P.D. + .703"

Roller Chain Sprockets

Single Strand No. 80 1" Pitch; Steel

ORDER BY CATALOG NUMBER OR ITEM CODE

No. of Teeth	Pitch Dia.	Bore	Catalog Number	Item Code
TYPE A NO HUB STEEL				
16	5.126	15/16	80A16	16356
17	5.442		80A17	16358
18	5.759		80A18	16360
19	6.079		80A19	16362
20	6.392		80A20	16364
21	6.710		80A21	16366
22	7.027		80A22	16368
23	7.344		80A23	16370
24	7.661		80A24	16372
25	7.979		80A25	16374
26	8.296	1-3/16	80A26	16376
30	9.567		80A30	16378
36	11.474		80A36	16382
40	12.745		80A40	16384
48	15.290	1-1/4	80A48	16388
50	15.926		80A54	46555
60	19.107		80A60	16392

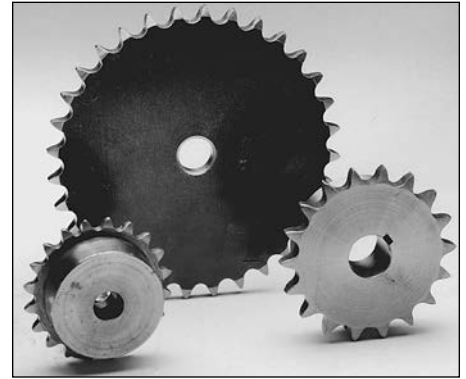

TYPE A

TYPE B

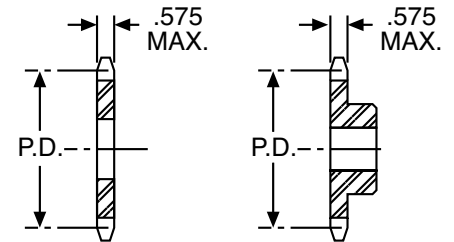

ORDER BY CATALOG NUMBER OR ITEM CODE

No. of Teeth	Pitch Dia.	Bore	Hub Dia.	Length thru Bore	With Keyway & Setscrew*		Without Keyway or Setscrew	
					Catalog Number	Item Code	Catalog Number	Item Code
TYPE B SINGLE HUB STEEL								
8	2.613	1	1-15/16	1-5/8	80B8-1*	46489	80B8	15870
9	2.924	1	2-1/4†	1-5/8	80B9-1*	46490	80B9	15872
		1-1/8			80B9-1-1/8*	46491		
		1-3/16			80B9-1-3/16*	15438		
		1-1/4			80B9-1-1/4*	46492		
10	3.236	1	2-9/16†	1-5/8	80B10-1	15440	80B10	15874
		1-1/8			80B10-1-1/8	46493		
		1-3/16			80B10-1-3/16	46494		
		1-1/4			80B10-1-1/4	15442		
11	3.549	1	2-13/16†	1-5/8	80B11-1	46495	80B11	15876
		1-1/8			80B11-1-1/8	46496		
		1-3/16			80B11-1-3/16	15444		
		1-1/4			80B11-1-1/4	15446		
		1-3/8			80B11-1-3/8	63651		
		1-7/16			80B11-1-7/16	15448		
		1-1/2			80B11-1-1/2*	15450		
		1-9/16			80B11-1-9/16*	46497		
		1-5/8			80B11-1-5/8*	15452		
		12			3.864	1	3-1/8†	1-5/8
1-1/8	80B12-1-1/8		63654					
1-3/16	80B12-1-3/16		63655					
1-1/4	80B12-1-1/4		15454					
1-3/8	80B12-1-3/8		63656					
1-7/16	80B12-1-7/16		15456					
1-1/2	80B12-1-1/2		15458					
1-9/16	80B12-1-9/16		63657					
1-5/8	80B12-1-5/8		15460					
1-3/4	80B12-1-3/4		15462					

MAXIMUM DIA. OF CHAIN OVER SPROCKET = SPROCKET P.D. + .875"

STANDARD TOLERANCES

DIMENSION		TOLERANCE	
Type A	Bore	All	+ .002 - .001
Type B	Bore	All	± .001

Reference Pages

- Alterations – 324
- Horsepower Ratings – 268-270
- Lubrication – 267
- Materials – 324
- Selection Procedure – 266
- ANSI Diameters – 325

*All sprockets have standard keyway. All sprockets have 3/8–16 setscrew, located over keyway except at 90° where marked.

†Has recessed groove in hub for chain clearance.

Roller Chain Sprockets

Single Strand

No. 80 1" Pitch; Steel

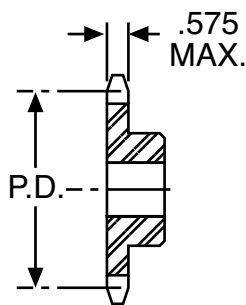
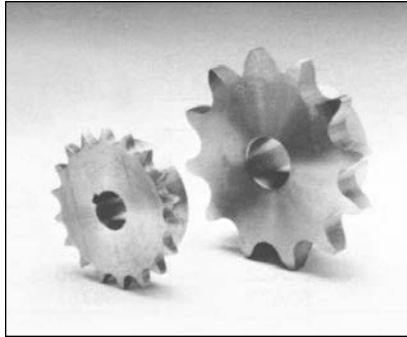

MAXIMUM DIA. OF CHAIN OVER SPROCKET = SPROCKET P.D. + .875"

STANDARD TOLERANCES

DIMENSIONS	TOLERANCE	
Bore	All	±.001

Reference Pages

Alterations – 324
 Horsepower Ratings – 268-270
 Lubrication – 267
 Materials – 324
 Selection Procedure – 266
 ANSI Diameters – 325

*All sprockets have standard keyway. All sprockets have 3/8–16 setscrew, located over keyway.

†Has recessed groove in hub for chain clearance.

ORDER BY CATALOG NUMBER OR ITEM CODE

No. of Teeth	Pitch Dia.	Bore	Hub Dia.	Length thru Bore	With Keyway & Setscrew*		Without Keyway or Setscrew									
					Catalog Number	Item Code	Catalog Number	Item Code								
TYPE B SINGLE HUB STEEL																
13	4.179		3	1-1/2	1	80B13-1	63658	80B13	15880							
					1-1/8	80B13-1-1/8	63659									
					1-3/16	80B13-1-3/16	63662									
					1-1/4	80B13-1-1/4	15464									
					1-3/8	80B13-1-3/8	63664									
					1-7/16	80B13-1-7/16	15466									
					1-1/2	80B13-1-1/2	15468									
					1-9/16	80B13-1-9/16	63666									
					1-5/8	80B13-1-5/8	15470									
					1-3/4	80B13-1-3/4	15472									
					1-7/8	80B13-1-7/8	63667									
					1-15/16	80B13-1-15/16	15474									
					2	80B13-2	15476									
					14	4.494				3-1/4	1-1/2	1	80B14-1	63669	80B14	15882
1-1/8	80B14-1-1/8	63670														
1-3/16	80B14-1-3/16	63708														
1-1/4	80B14-1-1/4	15478														
1-3/8	80B14-1-3/8	63709														
1-7/16	80B14-1-7/16	15480														
1-1/2	80B14-1-1/2	15482														
1-9/16	80B14-1-9/16	63710														
1-5/8	80B14-1-5/8	15484														
1-3/4	80B14-1-3/4	15486														
1-7/8	80B14-1-7/8	63711														
1-15/16	80B14-1-15/16	15488														
15	4.810		3-13/16	1-1/2				1	80B15-1			63712	80B15	15884		
								1-1/8	80B15-1-1/8			46498				
					1-3/16	80B15-1-3/16	46499									
					1-1/4	80B15-1-1/4	15492									
					1-7/16	80B15-1-7/16	15494									
					1-1/2	80B15-1-1/2	15496									
					1-9/16	80B15-1-9/16	63725									
					1-5/8	80B15-1-5/8	15498									
					1-3/4	80B15-1-3/4	15500									
					1-7/8	80B15-1-7/8	63726									
					1-15/16	80B15-1-15/16	15502									
					2	80B15-2	15504									
					16	5.126		4	1-1/2	1	80B16-1	35932			80B16	15886
										1-1/4	80B16-1-1/4	63734				
1-3/8	80B16-1-3/8	63735														
1-7/16	80B16-1-7/16	63736														
1-1/2	80B16-1-1/2	63737														
1-9/16	80B16-1-9/16	63738														
1-5/8	80B16-1-5/8	46500														
1-3/4	80B16-1-3/4	46501														
1-15/16	80B16-1-15/16	63765														
1	80B17-1	63775														
17	5.442		4	1-1/2	1-1/4	80B17-1-1/4	63776									
					1-3/8	80B17-1-3/8	63777									
					1-7/16	80B17-1-7/16	46502									
					1-1/2	80B17-1-1/2	46503									
					1-9/16	80B17-1-9/16	46504									
					1-5/8	80B17-1-5/8	46505									
					1-3/4	80B17-1-3/4	46506									
					1-15/16	80B17-1-15/16	46507									

Roller Chain Sprockets

Single Strand No. 80 1" Pitch; Steel

ORDER BY CATALOG NUMBER OR ITEM CODE

No. of Teeth	Pitch Diameter	Bore	Hub Dia.	Length thru Bore	With Keyway & Setscrew*		Without Keyway or Setscrew							
					Catalog Number	Item Code	Catalog Number	Item Code						
TYPE B SINGLE HUB STEEL														
18	5.759	1	4-1/4	1-1/2	80B18-1	46509	80B18	15890						
		1-1/4			80B18-1-1/4	46510								
		1-3/8			80B18-1-3/8	46511								
		1-7/16			80B18-1-7/16	46512								
		1-1/2			80B18-1-1/2	46513								
		1-9/16			80B18-1-9/16	63816								
		1-5/8			80B18-1-5/8	63820								
		1-3/4			80B18-1-3/4	63903								
		1-15/16			80B18-1-15/16	46514								
		2			80B18-2	63905								
		19			6.076	1			4-1/4	1-1/2	80B19-1	63911	80B19	15892
1-1/4	80B19-1-1/4		63912											
1-7/16	80B19-1-7/16		63935											
1-1/2	80B19-1-1/2		63936											
1-5/8	80B19-1-5/8		63951											
1-3/4	80B19-1-3/4		63953											
1-15/16	80B19-1-15/16		63954											
2	80B19-2		63955											
2-7/16	80B19-2-7/16		63956											
20	6.076		1	4-1/4		1-1/2	80B20-1	21968			80B20	15892		
		1-1/4	80B20-1-1/4		63962									
		1-7/16	80B20-1-7/16		63963									
		1-1/2	80B20-1-1/2		63964									
		1-5/8	80B20-1-5/8		63965									
		1-3/4	80B20-1-3/4		63966									
		1-15/16	80B20-1-15/16		63967									
		2	80B20-2		63969									
		2-7/16	80B20-2-7/16		63970									
		21	6.710		1		4-1/4	1-3/4	—	—			80B21	15896
		22	7.027		1		4-1/4	1-3/4	—	—			80B22	15898
23	7.344	1	4-1/4	1-3/4	—	—	80B23	16544						
24	7.661	1	4-1/4	1-3/4	—	—	80B24	16546						
25	7.979	1	4-1/4	1-3/4	—	—	80B25	16548						
26	8.296	1-1/4	4-3/4	2	—	—	80B26	16550						
30	9.567	1-3/16	4-3/4	2	—	—	80B30	16552						
36	11.474	1-3/16	4-3/4	2	—	—	80B36	16556						
40	12.745	1-3/16	4-3/4	2	—	—	80B40	16558						
48	15.290	1-1/4	4-3/4	2	—	—	80B48	16562						
60	19.107	1-1/4	5-1/4	2	—	—	80B60	16566						

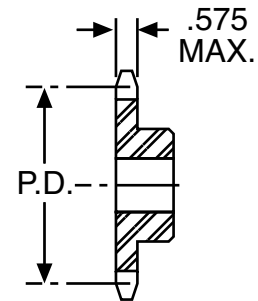
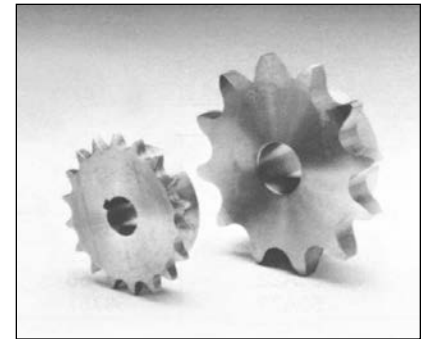

MAXIMUM DIA. OF CHAIN OVER SPROCKET = SPROCKET P.D. + .875"

STANDARD TOLERANCES

DIMENSION	TOLERANCE
Bore	All ±.001

Reference Pages

Alterations – 324
 Horsepower Ratings – 268-270
 Lubrication – 267
 Materials – 324
 Selection Procedure – 266
 ANSI Diameters – 325

*All sprockets have standard keyway. All sprockets have 3/8–16 setscrew, located over keyway.

Block Chain Sprockets

Type B Single Hub for 5/16" Wide B504 Block Chain Block Chain Sprockets*; Steel and Iron

ALL DIMENSIONS IN INCHES
ORDER BY CATALOG NUMBER OR ITEM CODE



Teeth	Pitch Diam.	Bore	Hub		Style	Catalog Number	Item Code
			Diameter	Project			
STEEL							
6	1.94	5/8	1-3/8	3/4	A	H917	14876
7	2.25	5/8	1-11/16	3/4	A	H918	14878
8	2.57	5/8	2	3/4	A	H919	14880
CAST IRON							
9	2.88	5/8	1-1/2	3/4	A	H920	16594
10	3.20	5/8	1-1/2	5/8	B	H921	16596
12	3.83	5/8	1-3/4	5/8	B	H922	16598

STANDARD TOLERANCES

DIMENSIONS	TOLERANCE	
Bore	All	±.001 - .000

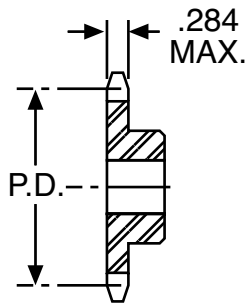

Reference Pages

Alterations – 324

Materials – 324

*For Block Chain refer to Page 253.

Ladder Chain Sprockets

Type B Single Hub

Nos. 1A and 1; Bronze and Steel (All Sprockets Equipped with Standard Setscrews, Except CBA 8)

ORDER BY CATALOG NUMBER OR ITEM CODE

Teeth	Pitch Diam.	Bore	Hub		Style	Catalog Number	Item Code
			Diameter	Project			
No. 1A							
BRONZE SPROCKETS							
8	.48	1/8	5/16†	7/32	Plain	CBA8	16856
10	.60	1/8	3/8	7/32	Plain	CBA10	16858
12	.71	3/16	7/16	7/32	Plain	CBA12	16860
15	.88	3/16	7/16	7/32	Plain	CBA15B	16862
18	1.06	3/16	1/2	1/4	Plain	CBA18B	16864
20	1.18	3/16	5/8	1/4	Plain	CBA20B	16866
24	1.41	3/16	3/4	1/4	Plain	CBA24B	16868
32	1.88	1/4	5/8	5/16	Plain	CBA32	16870
36	2.12	5/16	3/4	3/8	Plain	CBA36	16872
STEEL SPROCKETS							
7	.42	3/16	3/8†	1/2	Plain	CA7	14780
8	.48	3/16	7/16†	1/2	Plain	CA8	14782
9	.54	1/4	1/2†	1/2	Plain	CA9	14784
10	.60	1/4	9/16†	1/2	Plain	CA10	14786
12	.71	1/4	11/16†	1/2	Plain	CA12	14788
14	.83	1/4	3/4†	1/2	Plain	CA14	14790
16	.95	5/16	7/8†	1/2	Plain	CA16	14792
20	1.18	5/16	7/8	13/32	Plain	CA20	14794
24	1.41	5/16	7/8	13/32	Plain	CA24	14796
34	2.00	3/8	1-1/4	1/2	Plain	CA34	14798
42	2.47	3/8	1-1/4	1/2	Plain	CA42	14800
No. 1							
BRONZE SPROCKETS							
6	.57	3/16	11/32†	1/4	Plain	CB1 6	16878
8	.75	3/16	1/2	1/4	Plain	CB1 8	16880
10	.93	3/16	1/2	1/4	Plain	CB1 10	16882
11	1.01	3/16	1/2	1/4	Plain	CB1 11	16884
12	1.10	3/16	1/2	1/4	Plain	CB1 12	16886
14	1.28	1/4	5/8	5/16	Plain	CB1 14	16890
24	2.19	5/16	3/4	3/8	Plain	CB1 24	16900
32	2.92	5/16	3/4	3/8	Plain	CB1 32	16904

†Has Recessed Groove in Hub for Chain Clearance

STANDARD TOLERANCES

DIMENSION	TOLERANCE
Bore	All ±.001

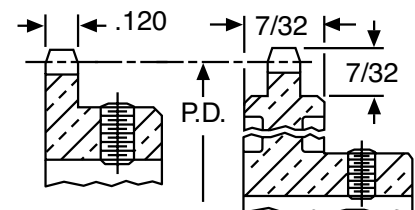
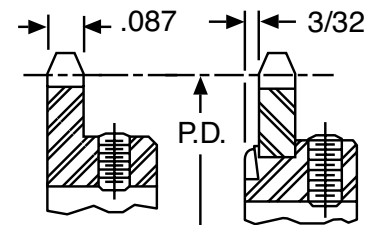
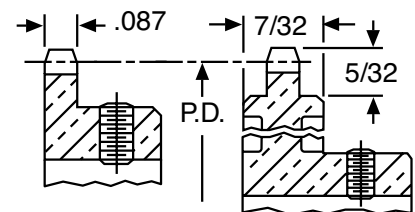

H

Ladder Chain Sprockets

Type B Single Hub

Nos. 1-2 and 2-1/2; Bronze and Steel (*All Sprockets Have Standard Setscrews*)



ALL DIMENSIONS IN INCHES
ORDER BY CATALOG NUMBER OR ITEM CODE

Teeth	Pitch Diam.	Bore	Hub		Style	Catalog Number	Item Code
			Diameter	Project			
No. 1							
STEEL SPROCKETS							
6	.57	1/4	1/2**	1/2	Plain	C1 6	14810
7	.66	1/4	9/16**	1/2	Plain	C1 7	14812
8	.75	5/16	11/16**	1/2	Plain	C1 8	14814
10	.93	5/16	7/8**	1/2	Plain	C1 10	14818
12	1.10	5/16	7/8	1/2	Plain	C1 12	14820
14	1.28	5/16	7/8	1/2	Plain	C1 14	14822
16	1.46	5/16	7/8	1/2	Plain	C1 16	14824
20	1.83	1/2	1-3/8	1/2	Plain	C1 20	14826
26	2.37	1/2	1-3/8	1/2	Plain	C1 26	14828
32	2.92	1/2	1-3/8	1/2	Plain	C1 32	14830
Nos. 2 and 2-1/2							
BRONZE SPROCKETS							
10	1.14	3/16	9/16	5/16	Web	CB3 10	16920
12	1.36	1/4	5/8	5/16	Web	CB3 12	16922
16	1.81	1/4	5/8	5/16	Web	CB3 16	16924
20	2.26	5/16	3/4	3/8	Web	CB3 20	16926
22	2.48	5/16	3/4	3/8	Web	CB3 22	16928
24	2.70	5/16	3/4	3/8	Web	CB3 24	16930
45	5.06	3/8	7/8	7/16	Spoke	CB3 45	16936
STEEL SPROCKETS							
8	.92	3/8	13/16†	11/16	Plain	C3 8	14842
9	1.03	3/8	15/16†	11/16	Plain	C3 9	14844
10	1.14	3/8	1-1/32†	11/16	Plain	C3 10	14846
12	1.36	1/2	1-1/4†	11/16	Plain	C3 12	14850
14	1.59	1/2	1-1/4	11/16	Plain	C3 14	14852
16	1.81	1/2	1-15/32	11/16	Plain	C3 16	14854
20	2.26	1/2	1-1/2	11/16	Plain	C3 20	14856
30	3.38	1/2	1-5/8	11/16	Plain	C3 30	14860

**Blind hole—3/4" deep from Hub End.

†Has Recessed Groove in Hub for Chain Clearance

STANDARD TOLERANCES

DIMENSIONS	TOLERANCE	
Bore	All	±.001

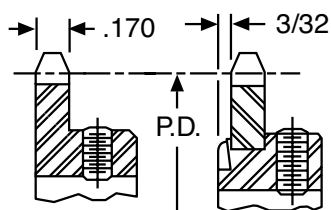
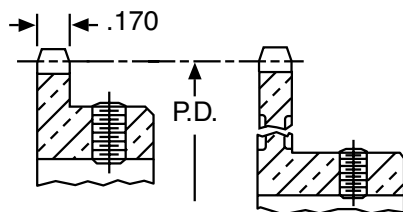
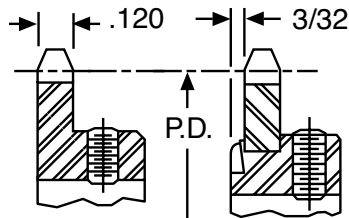

H

Roller Chain Drive Tensioners

Screw Adjustable/Spring Adjustable/Shaft Mounted Non-Adjustable (Drive Positioners)

Boston Gear chain drive tensioners improve drive performance by eliminating whipping and slipping of loose chains. They reduce vibration, noise and maintenance and provide additional life to drive components. They are also suitable for flat-face and V-Belt drive systems and are provided with a grease fitting for lubricating idler bearings other than Bost-Bronz.

All tensioners are constructed of structural steel and are available for use with Roller Chains up to 1-1/2" Pitch. No. 120.

Installation Instructions

- Idlers should be located on the slack side of the drive chain.
- Chain idlers should be run on the outside of the chain.
- Idler sprockets should have at least three teeth engaged with the chain.
- Idlers, when used on the outside of the drive, should be located approximately 1/3 of the center distance from the large sprocket.
- Idlers, when used on the inside of the drive, should be located approximately 1/3 of the center distance from the large sprocket.
- Tensioning that is too tight causes excessive wear on the chain and bearings.
- Tensioning that is too loose allows chain vibration, causing loss of horsepower or wear.

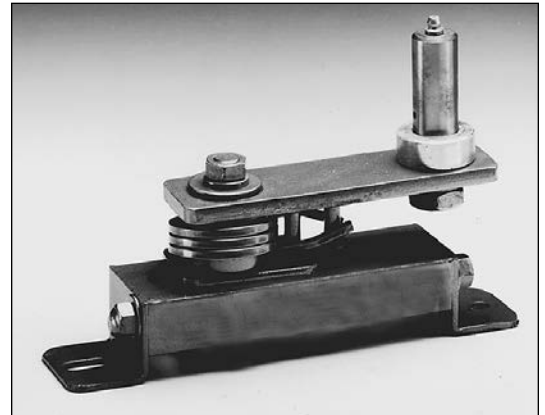

Idler Sprockets

ORDER BY CATALOG NUMBER OR ITEM CODE

For Use with Chain No.	Hole Diameter	No. of Teeth	Catalog Number	Item Code
35	1/2	12	35B12TI-8	48901
		15	35B15TI-8	48902
		18	35B18TI-8	48903
40	1/2	9	40B9TI-8	48904
		12	40B12TI-8	48905
		15	40B15TI-8	48906
	7/8	12	40B12TI-14	48910
		15	40B15TI-14	48911
		18	40B18TI-14	48912
41	1/2	9	41B9TI-8	48907
		12	41B12TI-8	48908
		15	41B15TI-8	48909
	7/8	15	41B15TI-14	48913
		18	41B18TI-14	48914
50	7/8	12	50B12TI-14	48915
		15	50B15TI-14	48916
		18	50B18TI-14	48917
60	7/8	12	60B12TI-14	48918
		15	60B15TI-14	48919
		18	60B18TI-14	48920
	1-1/8	12	60B12TI-18	48921
		15	60B15TI-18	48922
		18	60B18TI-18	48923
80	1-1/8	12	80B12TI-18	48924
		15	80B15TI-18	48925
		18	80B18TI-18	48926

Boston stocks a wide range of idler sprockets for use with its chain drive tensioners and positioners. In addition special sizes and configurations can be furnished to order. All idlers are equipped with Bost-Bronz, oil impregnated bushings. Grease lubrication is not recommended. Use normal relubrication procedure for oil-impregnated bearings.

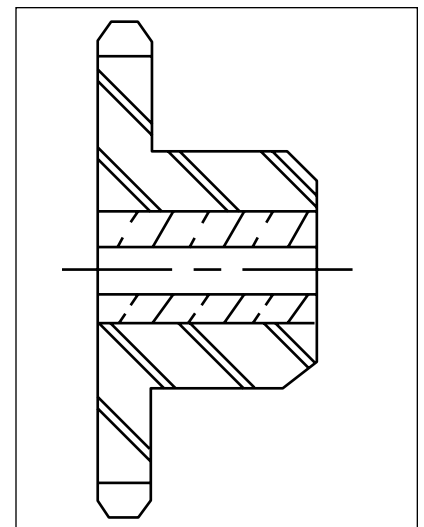

Roller Chain Drive Tensioners

Type LG Shaft Mounted

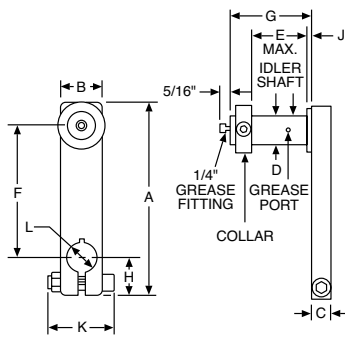

This shaft-mounted tensioner is best suited for applications where it is impractical to bolt the tensioner on a frame. This tensioner can be mounted at any point on a shaft and is adjustable to any location in a 360° arc on the shaft.

ORDER BY CATALOG NUMBER OR ITEM CODE

Suggested Chain Number*	Catalog Number	Item Code
35, 40, 41	0-LG	48888
40, 50, 60	1-LG	48889
80, 100, 120	2-LG	48890

*Single-strand chain. For multiple strand chain, use larger tensioner.

ALL DIMENSIONS IN INCHES

Size	A	B	C	D	E	F	G	H	J	K	L
0-LG	4	7/8	3/4	.500	1	2-1/2	1-9/16	7/8	1/16	1-5/8	.500
1-LG	6	1-1/4	1	.875	1-3/4	4	2-15/32	1-3/16	3/32	2-1/8	.875
2-LG	8	1-1/2	1-1/4	1.125	2-7/8	5-1/2	3-21/32	1-3/8	1/8	2-3/4	1.125

Type BG Screw Adjustable

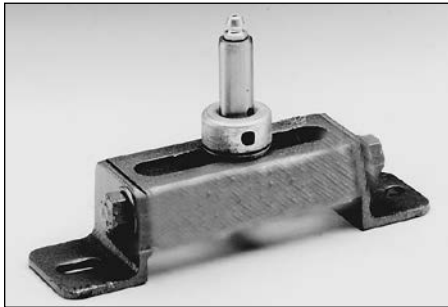

These Boston Gear tensioners use a screw for precise, easily adjustable tension, to provide maximum life for the sprocket and chain. These tensioners are useful on vertical drives to prevent lower sprocket disengagement and on heavy chains where slack is normally taken up by hand, while making the adjustment. With these tensioners chain take-up and tension are both controlled with the screw.

Many drive systems are enclosed for safety reasons. With conventional tensioners, the enclosure must be removed for drive adjustment. With Boston tensioners adjustments can be made to the head of the screw, substantially reducing cost maintenance and drive down time. The screw is adjustable from either end of the tensioner.

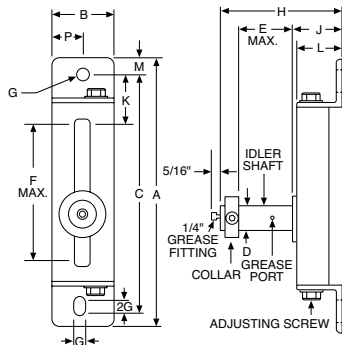

ORDER BY CATALOG NUMBER OR ITEM CODE

Suggested Chain Number*	Catalog Number	Item Code
35, 40, 41	0-BG	48878
40, 50, 60	1-BG	48879
80, 100, 120	2-BG	48880

*Single-strand chain. For multiple strand chain, use larger tensioner.

ALL DIMENSIONS IN INCHES

Size	A	B	C	D	E	F	G	2G	H	J	K	L	M	P	Wgt.
0-BG	5-7/8	1-1/2	5-1/4	.500	1	2-1/2	9/32	3/8	2-13/16	1-5/16	1-3/8	1-1/4	3/8	3/4	1 LB.
1-BG	9	2	8-1/8	.875	1-3/4	4-1/2	11/32	1/2	4	1-5/8	1-3/4	1-1/2	1/2	1	2-1/2 LB.
2-BG	13	3	11-7/8	1.125	2-7/8	6	9/16	3/4	5-11/16	2-5/32	2-7/8	2	5/8	1-1/2	6 LB.

Roller Chain Drive Tensioners

Type BG Spring Adjustable

The Boston Gear Series 50 Tensioner is a screw-adjustable tensioner with a spring-loaded pivot arm. The arm maintains tension on the chain and automatically takes up the slack due to cycle loading or wear. It offers all the advantages of the screw adjustable tensioner plus the automatic take-up feature, which substantially reduces maintenance. The double-coil spring is loaded by turning the adjustment screw in the base of the unit, forcing the idler arm against the slack side of the chain.

The Series 60 Tensioner has a spring-loaded pivot arm but does not have the screw-type adjustment. It is used in lighter applications (#35-#60 chain) when automatic take-up is desired. Since the pivot arm must be adjusted by hand, the mounting location of the tensioner is important.

On both the Series 50 and 60 Tensioners, the pivot arm swings 90° from the center line in either direction, however, it must be positioned to swing in the direction of chain travel.

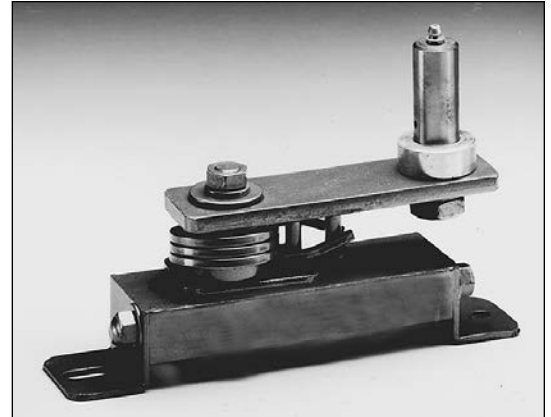

Series 50 dimensions

ORDER BY CATALOG NUMBER OR ITEM CODE

Suggested Chain Number*	Available Load at Idler Shaft @90°	Catalog Number	Item Code
40, 50, 60 80, 100, 120	63 Lbs. 105 Lbs.	51-BG 52-BG	48883 48884
35, 40, 41 50, 60	32.2 Lbs. 33.3 Lbs.	60-BG 61-BG	48886 48887

*Single-strand chain. For multiple strand chain, use large tensioner.

Available load at idler shaft is the maximum amount of force on the chain developed by the spring loaded arm when deflected 90° to either side of the neutral position.

The basic spring preload is 20% of the total capability. The load curve is a straight line proportion of load to angle of deflection. Upon request, lighter springs can be supplied for all units. Heavier springs (to 150% of above capacity) can be furnished for all units except #60BG and #61BG.

Depending on application, please allow a service factor for spring capacity.

Springs are shot-peened for longer life.

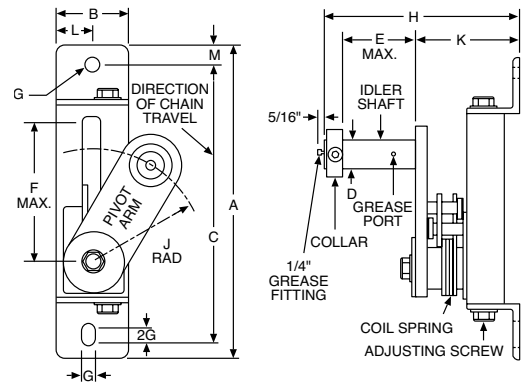

ALL DIMENSIONS IN INCHES

Size	A	B	C	D	E	F	G	2G	H	J	K	L	M	Wgt.
51BG	9	2	8-1/8	.875	1-3/4	2-1/2	11/32	1/2	5-3/8	4-1/4	3	1	1/2	5 Lb.
52BG	13	3	11-7/8	1.125	2-7/8	4	9/16	3/4	7-13/16	4-3/4	3-7/8	1-1/2	5/8	10 Lb.

Series 60 Dimensions

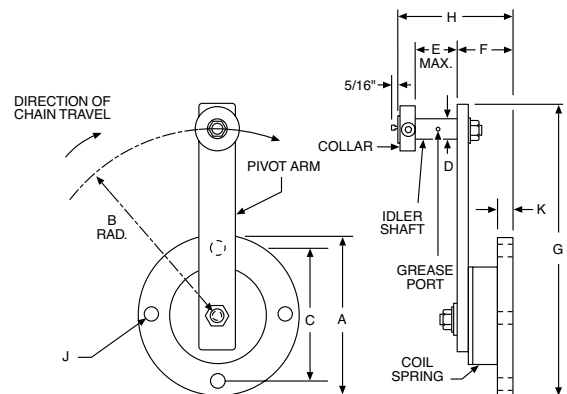

ALL DIMENSIONS IN INCHES

Size	A	B	C	D	E	F	G	2G	H	J	K	L	M	Wgt.
60BG	4	4-3/4	3-3/8	.500	1	1-3/8	7-3/8	—	2-7/8	9/32	1/4	—	—	2 Lb.
61BG	5-1/2	6	4-3/4	.875	1-3/4	1-7/8	9-1/2	—	4-1/4	13/32	5/16	—	—	5 Lb.

Roller Chain Drive Tensioners

Type HG Drive Positioners

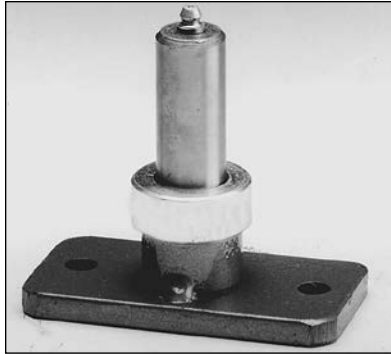

The Type HG is an angle-mounted positioner which can be mounted on any flat horizontal surface. Its variety of sizes provides advantages not enjoyed from competitive brands.

ORDER BY CATALOG NUMBER OR ITEM CODE

Suggested Chain Number*	Catalog Number	Item Code
35, 40, 41	0-HG	48897
40, 50, 60	1-HG	48898
80, 100, 120	2-HG	48899

*Single-strand chain. For multiple strand chain, use larger tensioner.

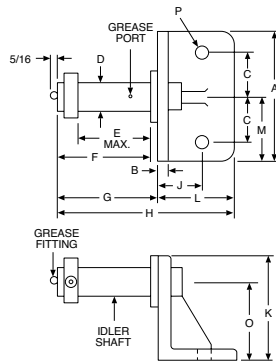

ALL DIMENSIONS IN INCHES

Size	A	B	C	D	E	F	G	H	J	K	L	M	O	P
0-HG	2-3/4	1/4	1	1/2	1	1-1/2	1-9/16	3-1/16	7/8	2	1-1/2	1--3/8	1-1/2	11/32
1-HG	4	5/16	1-1/2	7/8	1-3/4	2-3/8	2-15/32	4-15/32	1-1/8	3	2	2	2-1/16	13/32
2-HG	5	7/16	1-3/4	1-1/8	2-7/8	3-17/32	3-5/8	6-21/32	1-3/4	4	3	2-1/2	3	9/16

Type UG Drive Positioners

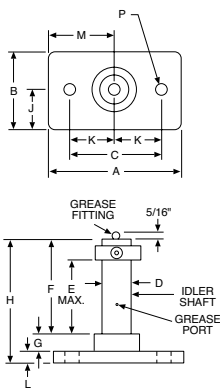

The Type UG drive positioner is a fixed idler bracket which provides chain support. Available in a variety of sizes. Type UG positioners can be mounted on any flat, vertical surface.

ORDER BY CATALOG NUMBER OR ITEM CODE

Suggested Chain Number*	Catalog Number	Item Code
35, 40, 41	0-UG	48893
40, 50, 60	1-UG	48894
80, 100, 120	2-UG	48895

*Single-strand chain. For multiple strand chain, use larger tensioner.

ALL DIMENSIONS IN INCHES

Size	A	B	C	D	E	F	G	H	J	K	L	M	P
0-UG	2-3/4	1-1/2	2	1/2	1	1-1/2	7/16	2-3/16	3/4	1	1/4	1-3/8	11/32
1-UG	4	2	3	7/8	1-3/4	2-3/8	9/16	3-1/4	1	1-1/2	5/16	2	13/32
2-UG	5	3	3-1/2	1-1/8	2-7/8	3-17/32	3/4	4-25/32	1-1/2	1-3/4	1/2	2-1/2	9/16

SPUR GEARS

Nomenclature	306-307
Involute Form.....	308
Diametral Pitch / Pressure Angle / Tooth Dimensions.....	309
Backlash / Undercut / Formulas	310
Lewis Formula.....	311

HELICAL GEARS

Nomenclature / Helix Angle.....	312
Formulas	313
Thrust Loads.....	314

MITER & BEVEL GEARS

Nomenclature	315
Mounting Distance	316
Tooth Strength / Thrust	317

WORMS & WORM GEARS

Hand / Efficiency / Thrust Loads.....	318
Formulas / Self-Locking.....	319

COUPLING / UNIVERSAL JOINTS..... 320

GENERAL INFORMATION

How To Figure Horsepower & Torque	321
Mountings / Alterations / Lubrication.....	322
Materials / Styles / Keyways & Setscrews.....	323
Sprockets, Sprocket Diameters	324-326
Horsepower & Torque Capacity of Shafting	327
Temperature Conversion Table.....	328
Equivalent Table	329
Metric Conversion Chart	330
Application Classifications	331-332

INDEX TO CATALOG NUMBERS..... 333-334

Spur Gears

Gear Nomenclature

ADDENDUM (a) is the height by which a tooth projects beyond the pitch circle or pitch line.

BASE DIAMETER (D_b) is the diameter of the base cylinder from which the involute portion of a tooth profile is generated.

BACKLASH (B) is the amount by which the width of a tooth space exceeds the thickness of the engaging tooth on the pitch circles. As actually indicated by measuring devices, backlash may be determined variously in the transverse, normal, or axial-planes, and either in the direction of the pitch circles or on the line of action. Such measurements should be corrected to corresponding values on transverse pitch circles for general comparisons.

BORE LENGTH is the total length through a gear, sprocket, or coupling bore.

CIRCULAR PITCH (p) is the distance along the pitch circle or pitch line between corresponding profiles of adjacent teeth.

CIRCULAR THICKNESS (t) is the length of arc between the two sides of a gear tooth on the pitch circle, unless otherwise specified.

CLEARANCE-OPERATING (c) is the amount by which the dedendum in a given gear exceeds the addendum of its mating gear.

CONTACT RATIO (m_c) in general, the number of angular pitches through which a tooth surface rotates from the beginning to the end of contact.

DEDENDUM (b) is the depth of a tooth space below the pitch line. It is normally greater than the addendum of the mating gear to provide clearance.

DIAMETRICAL PITCH (P) is the ratio of the number of teeth to the pitch diameter.

FACE WIDTH (F) is the length of the teeth in an axial plane.

FILLET RADIUS (r_f) is the radius of the fillet curve at the base of the gear tooth.

FULL DEPTH TEETH are those in which the working depth equals 2.000 divided by the normal diametral pitch.

GEAR is a machine part with gear teeth. When two gears run together, the one with the larger number of teeth is called the gear.

HUB DIAMETER is outside diameter of a gear, sprocket or coupling hub.

HUB PROJECTION is the distance the hub extends beyond the gear face.

INVOLUTE TEETH of spur gears, helical gears and worms are those in which the active portion of the profile in the transverse plane is the involute of a circle.

LONG- AND SHORT-ADDENDUM TEETH are those of engaging gears (on a standard designed center distance) one of which has a long addendum and the other has a short addendum.

KEYWAY is the machined groove running the length of the bore. A similar groove is machined in the shaft and a key fits into this opening.

NORMAL DIAMETRICAL PITCH (P_n) is the value of the diametral pitch as calculated in the normal plane of a helical gear or worm.

NORMAL PLANE is the plane normal to the tooth surface at a pitch point and perpendicular to the pitch plane. For a helical gear this plane can be normal to one tooth at a point laying in the plane surface. At such point, the normal plane contains the line normal to the tooth surface and this is normal to the pitch circle.

NORMAL PRESSURE ANGLE (ϕ_n) in a normal plane of helical tooth.

OUTSIDE DIAMETER (D_o) is the diameter of the addendum (outside) circle.

PITCH CIRCLE is the circle derived from a number of teeth and a specified diametral or circular pitch. Circle on which spacing or tooth profiles is established and from which the tooth proportions are constructed.

PITCH CYLINDER is the cylinder of diameter equal to the pitch circle.

PINION is a machine part with gear teeth. When two gears run together, the one with the smaller number of teeth is called the pinion.

PITCH DIAMETER (D) is the diameter of the pitch circle. In parallel shaft gears, the pitch diameters can be determined directly from the center distance and the number of teeth.

PRESSURE ANGLE (ϕ) is the angle at a pitch point between the line of pressure which is normal to the tooth surface, and the plane tangent to the pitch surface. In involute teeth, pressure angle is often described also as the angle between the line of action and the line tangent to the pitch circle. Standard pressure angles are established in connection with standard gear-tooth proportions.

ROOT DIAMETER (D_r) is the diameter at the base of the tooth space.

PRESSURE ANGLE—OPERATING (ϕ) is determined by the center distance at which the gears operate. It is the pressure angle at the operating pitch diameter.

TIP RELIEF is an arbitrary modification of a tooth profile whereby a small amount of material is removed near the tip of the gear tooth.

UNDERCUT is a condition in generated gear teeth when any part of the fillet curve lies inside a line drawn tangent to the working profile at its point of juncture with the fillet.

WHOLE DEPTH (h_t) is the total depth of a tooth space, equal to addendum plus dedendum, equal to the working depth plus variance.

WORKING DEPTH (h_k) is the depth of engagement of two gears; that is, the sum of their addendums.

Tooth Parts

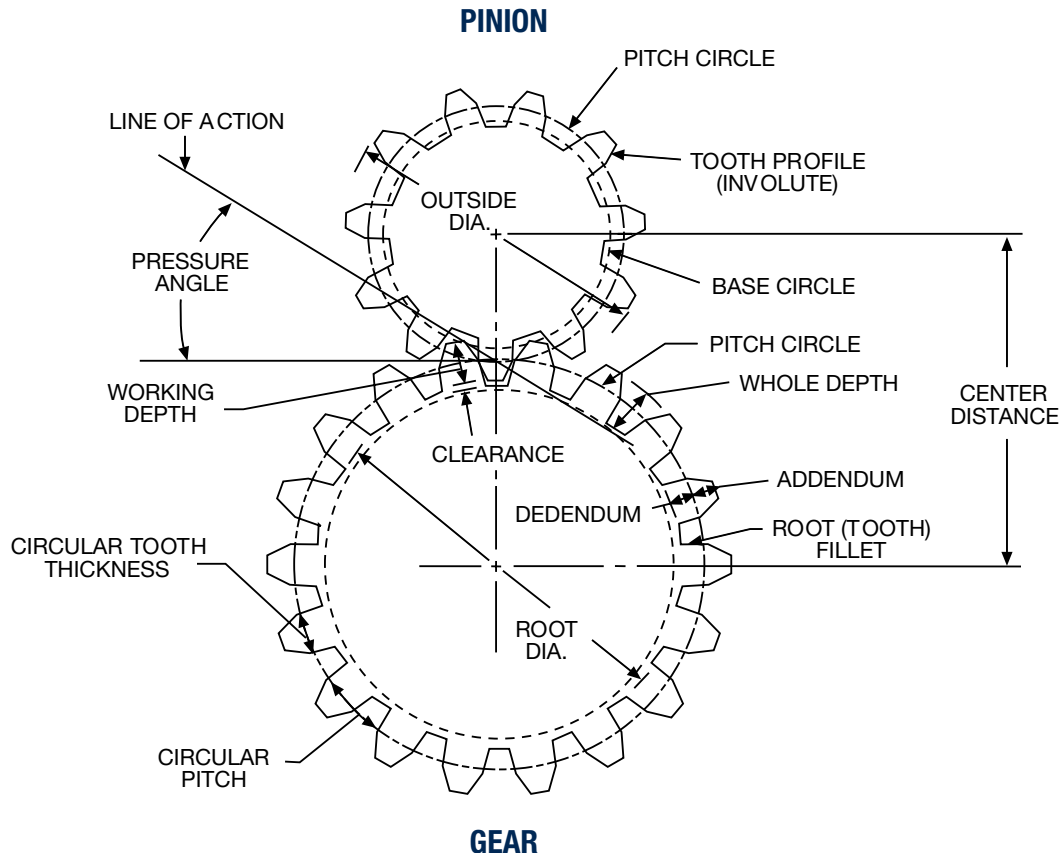

Spur Gears

Involute Form

Gear teeth could be manufactured with a wide variety of shapes and profiles. The involute profile is the most commonly used system for gearing today, and all Boston spur and helical gears are of involute form.

An involute is a curve that is traced by a point on a taut cord unwinding from a circle, which is called a BASE CIRCLE. The involute is a form of spiral, the curvature of which becomes straighter as it is drawn from a base circle and eventually would become a straight line if drawn far enough.

An involute drawn from a larger base circle will be less curved (straighter) than one drawn from a smaller base circle. Similarly, the involute tooth profile of smaller gears is considerably curved, on larger gears is less curved (straighter), and is straight on a rack, which is essentially an infinitely large gear.

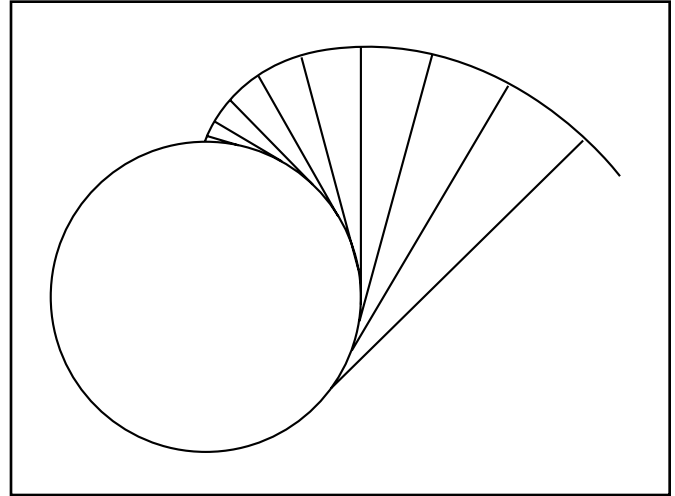
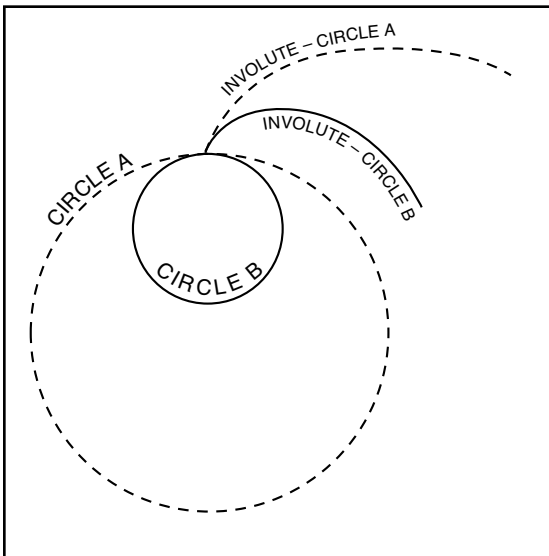

Involute gear tooth forms and standard tooth proportions are specified in terms of a basic rack which has straight-sided teeth, for involute systems.



Diametral Pitch System

All stock gears are made in accordance with the diametral pitch system. The diametral pitch of a gear is the number of teeth in the gear for each inch of pitch diameter. Therefore, the diametral pitch determines the size of the gear tooth.

Pressure Angle

Pressure angle is the angle at a pitch point between the line of pressure which is normal to the tooth surface, and the plane tangent to the pitch surface. The pressure angle, as defined in this catalog, refers to the angle when the gears are mounted on their standard center distances.

Boston Gear manufactures both 14-1/2° and 20° PA, involute, full depth system gears. While 20°PA is generally recognized as having higher load carrying capacity, 14-1/2°PA gears have extensive use. The lower pressure angle results in less change in backlash due to center distance variation and concentricity errors. It also provides a higher contact ratio and consequent smoother, quieter operation provided that undercut of teeth is not present.

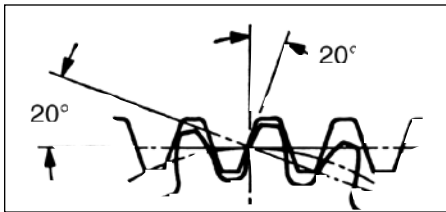
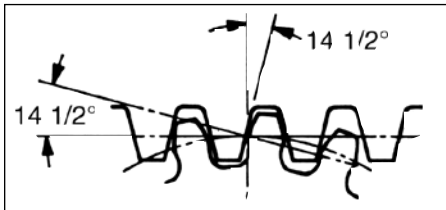

Tooth dimensions

For convenience, Tooth Proportions of various standard diametral pitches of Spur Gears are given below.

Diametral Pitch	Circular Pitch (Inches)	Thickness of Tooth on Pitch Line (Inches)	Depth to be Cut in Gear (Inches) (Hobbed Gears)	Addendum (Inches)
3	1.0472	.5236	.7190	.3333
4	.7854	.3927	.5393	.2500
5	.6283	.3142	.4314	.2000
6	.5236	.2618	.3565	.1667
8	.3927	.1963	.2696	.1250
10	.3142	.1571	.2157	.1000
12	.2618	.1309	.1798	.0833
16	.1963	.0982	.1348	.0625
20	.1571	.0785	.1120	.0500
24	.1309	.0654	.0937	.0417
32	.0982	.0491	.0708	.0312
48	.0654	.0327	.0478	.0208
64	.0491	.0245	.0364	.0156

20°P.A.	14 1/2°P.A.
64 D.P.	
48 D.P.	48 D.P.
32 D.P.	32 D.P.
24 D.P.	24 D.P.
20 D.P.	20 D.P.
16 D.P.	16 D.P.
12 D.P.	12 D.P.
10 D.P.	10 D.P.
8 D.P.	8 D.P.
6 D.P.	6 D.P.
5 D.P.	5 D.P.
4 D.P.	4 D.P.
Tooth Gauge Chart is for Reference Purposes Only.	3 D.P.

Engineering Information

Spur Gears

Backlash

Stock spur gears are cut to operate at standard center distances. The standard center distance being defined by:

$$\text{Standard Center Distance} = \frac{\text{Pinion PD} + \text{Gear PD}}{2}$$

When mounted at this center distance, stock spur gears will

Diametral Pitch	Backlash (Inches)	Diametral Pitch	Backlash (Inches)
3	.013	8-9	.005
4	.010	10-13	.004
5	.008	14-32	.003
6	.007	33-64	.0025
7	.006		

have the following average backlash:

An increase or decrease in center distance will cause an increase or decrease in backlash.

Since, in practice, some deviation from the theoretical standard center distance is inevitable and will alter the backlash, such deviation should be as small as possible. For most applications, it would be acceptable to limit the deviation to an increase over the nominal center distance of one half the average backlash. Varying the center distance may afford a practical means of varying the backlash to a limited extent.

The approximate relationship between center distance and backlash change of 14-1/2° and 20° pressure angle gears is shown below:

$$\text{For } 14\text{-}1/2^\circ \text{—Change in Center Distance} = 1.933 \times \text{Change in Backlash}$$

$$\text{For } 20^\circ \text{—Change in Center Distance} = 1.374 \times \text{Change in Backlash}$$

From this, it is apparent that a given change in center distance, 14-1/2° gears will have a smaller change in backlash than 20° gears. This fact should be considered in cases where backlash is critical.

Undercut

When the number of teeth in a gear is small, the tip of the mating gear tooth may interfere with the lower portion of the tooth profile. To prevent this, the generating process removes material at this point. This results in loss of a portion of the involute adjacent to the tooth base, reducing tooth contact and tooth strength.

On 14-1/2°PA gears undercutting occurs where a number of teeth is less than 32 and for 20°PA less than 18. Since this condition becomes more severe as tooth numbers decrease, it is recommended that the minimum number of teeth be 16 for 14-1/2°PA and 13 for 20°PA.

In a similar manner INTERNAL Spur Gear teeth may interfere when the pinion gear is too near the size of its mating internal gear. The following may be used as a guide to assure proper operation of the gear set. For 14-1/2°PA, the difference in tooth numbers between the gear and pinion should not be less than 15. For 20°PA the difference in tooth numbers should not be less than 12.

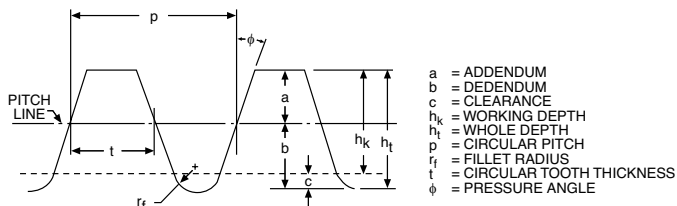

Spur Gear Formulas

FOR FULL DEPTH INVOLUTE TEETH

To Obtain	Having	Formula
Diametral Pitch (P)	Circular Pitch (p)	$P = \frac{3.1416}{p}$
	Number of Teeth (N) & Pitch Diameter (D)	$P = \frac{N}{D}$
	Number of Teeth (N) & Outside Diameter (D _o)	$P = \frac{N + 2}{D_o}$ (Approx.)
Circular Pitch (p)	Diametral Pitch (P)	$p = \frac{3.1416}{P}$
Pitch Diameter (D)	Number of Teeth (N) & Diametral Pitch (P)	$D = \frac{N}{P}$
	Outside Diameter (D _o) & Diametral Pitch (P)	$D = D_o - \frac{2}{P}$
Base Diameter (D _b)	Pitch Diameter (D) and Pressure Angle (φ)	$D_b = D \cos \phi$
Number of Teeth (N)	Diametral Pitch (P) & Pitch Diameter (D)	$N = P \times D$
Tooth Thickness (t) @ Pitch Diameter (D)	Diametral Pitch (P)	$t = \frac{1.5708}{P}$
Addendum (a)	Diametral Pitch (P)	$a = \frac{1}{P}$
Outside Diameter (D _o)	Pitch Diameter (D) & Addendum (a)	$D_o = D + 2a$
Whole Depth (h _t) (20P & Finer)	Diametral Pitch (P)	$h_t = \frac{2.2}{P} + .002$
Whole Depth (h _t) (Coarser than 20P)	Diametral Pitch (P)	$h_t = \frac{2.157}{P}$
Working Depth (h _k)	Addendum (a)	$h_k = 2(a)$
Clearance (c)	Whole Depth (h _t) & Addendum (a)	$c = h_t - 2a$
Dedendum (b)	Whole Depth (h _t) & Addendum (a)	$b = h_t - a$
Contact Ratio (M _C)	Outside Radii, Base Radii, Center Distance and Pressure Angle+C.P.	$M-C = \frac{\sqrt{R_o^2 - R_b^2} + \sqrt{r_o^2 - r_b^2} - C \sin \phi^*}{p \cos \phi}$
Root Diameter (D ^r)	Pitch Diameter (D) and Dedendum (b)	$D^r = D - 2b$
Center Distance (C)	Pitch Diameter (D) or No. of Teeth and Pitch	$C = \frac{D_1 + D_2}{2}$ or $\frac{N_1 + N_2}{2P}$

R_o = Outside Radius, Gear
 r_o = Outside Radius, Pinion
 R_b = Base Circle Radius, Gear
 r_b = Base Circle Radius, Pinion

Lewis Formula (Barth Revision)

Gear failure can occur due to tooth breakage (tooth stress) or surface failure (surface durability) as a result of fatigue and wear. Strength is determined in terms of tooth-beam stresses for static and dynamic conditions, following well established formula and procedures. Satisfactory results may be obtained by the use of Barth's Revision to the Lewis Formula, which considers beam strength but not wear. The formula is satisfactory for commercial gears at Pitch Circle velocities of up to 1500 FPM. It is this formula that is the basis for all Boston Spur Gear ratings.

METALLIC SPUR GEARS

$$W = \frac{SFY}{P} \left(\frac{600}{600 + V} \right)$$

- W = Tooth Load, Lbs. (along the Pitch Line)
- S = Safe Material Stress (static) Lbs. per Sq. In. (Table II)
- F = Face Width, In.
- Y = Tooth Form Factor (Table I)
- P = Diametral Pitch
- D = Pitch Diameter
- V = Pitch Line Velocity, Ft. per Min. = .262 x D x RPM

For NON-METALLIC GEARS, the modified Lewis Formula shown below may be used with (S) values of 6000 PSI for Phenolic Laminated material.

$$W = \frac{SFY}{P} \left(\frac{150}{200 + V} + .25 \right)$$

TABLE II-VALUES OF SAFE STATIC STRESS (s)

Material	(s) Lb. per Sq. In.
Plastic	5000
Bronze	10000
Cast Iron.....	12000
.20 Carbon (Untreated).....	20000
.20 Carbon (Case-hardened).....	25000
.40 Carbon (Untreated).....	25000
.40 Carbon (Heat-treated).....	30000
.40 C. Alloy (Heat-treated).....	40000

Max. allowable torque (T) that should be imposed on a gear will be the safe tooth load (W) multiplied by $\frac{D}{2}$ or $T = \frac{W \times D}{2}$

The safe horsepower capacity of the gear (at a given RPM) can be calculated from $HP = \frac{T \times RPM}{63,025}$ or directly from (W) and (V);

$$HP = \frac{WV}{33,000}$$

$$\text{For a known HP, } T = \frac{63025 \times HP}{RPM}$$

TABLE I TOOTH FORM FACTOR (Y)

Number of Teeth	14-1/2° Full Depth Involute	20° Full Depth Involute
10	0.176	0.201
11	0.192	0.226
12	0.210	0.245
13	0.223	0.264
14	0.236	0.276
15	0.245	0.289
16	0.255	0.295
17	0.264	0.302
18	0.270	0.308
19	0.277	0.314
20	0.283	0.320
22	0.292	0.330
24	0.302	0.337
26	0.308	0.344
28	0.314	0.352
30	0.318	0.358
32	0.322	0.364
34	0.325	0.370
36	0.329	0.377
38	0.332	0.383
40	0.336	0.389
45	0.340	0.399
50	0.346	0.408
55	0.352	0.415
60	0.355	0.421
65	0.358	0.425
70	0.360	0.429
75	0.361	0.433
80	0.363	0.436
90	0.366	0.442
100	0.368	0.446
150	0.375	0.458
200	0.378	0.463
300	0.382	0.471
Rack	0.390	0.484

Helical Gears

Gear Nomenclature

The information contained in the Spur Gear section is also pertinent to Helical Gears with the addition of the following:

HELIX ANGLE (ψ) is the angle between any helix and an element of its cylinder. In helical gears, it is at the pitch diameter unless otherwise specified.

LEAD (L) is the axial advance of a helix for one complete turn, as in the threads of cylindrical worms and teeth of helical gears.

NORMAL DIAMETRAL PITCH (P_n) is the Diametral Pitch as calculated in the normal plane.

HAND – Helical Gears of the same hand operate at right angles, see Fig. 1

Helical Gears of opposite hands run on parallel shafts. Fig. 2



TWO
RIGHT-HAND
HELICAL GEARS



TWO
LEFT-HAND
HELICAL GEARS

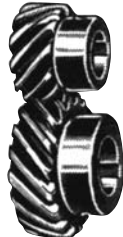

LEFT-HAND AND
RIGHT-HAND
HELICAL GEARS

Figure 1

Figure 2

LEFT HAND HELICAL GEAR



The teeth of a LEFT HAND Helical Gear lean to the left when the gear is placed flat on a horizontal surface.

RIGHT HAND HELICAL GEAR



The teeth of a RIGHT HAND Helical Gear lean to the right when the gear is placed flat on a horizontal surface.

Helix Angle—

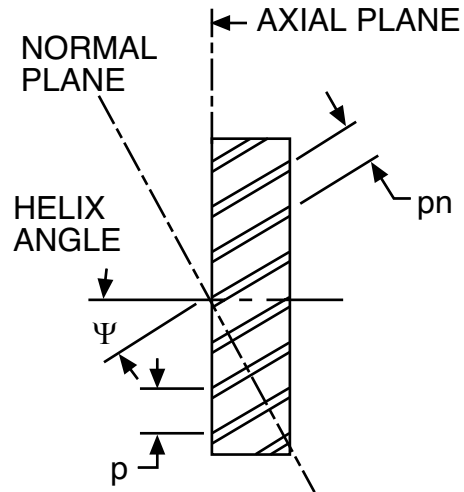

p = AXIAL CIRCULAR PITCH
 p_n = NORMAL CIRCULAR PITCH

All Boston Helicals are cut to the Diametral Pitch system, resulting in a Normal Pitch which is lower in number than the Diametral Pitch.

INVOLUTE—The Helical tooth form is involute in the plane of rotation and can be developed in a manner similar to that of the Spur Gear. However, unlike the Spur Gear, which may be viewed as two-dimensional, the Helical Gear must be viewed as three-dimensional to show change in axial features.

Helical gears offer additional benefits relative to Spur Gears, those being:

- Improved tooth strength due to the elongated helical wrap-around.
- Increased contact ratio due to the axial tooth overlap.
- Helical Gears thus tend to have greater load carrying capacity than Spur Gears of similar size.
- Due to the above, smoother operating characteristics are apparent.

Helical Gear Formulas

To Obtain	Having	Formula
Transverse Diametral Pitch (P)	Number of Teeth (N) & Pitch Diameter (D)	$P = \frac{N}{D}$
	Normal Diametral Pitch (P _N) & Helix Angle (ψ)	$P = P_N \cos \psi$
Pitch Diameter (D)	Number of Teeth (N) & Transverse Diametral Pitch (P)	$D = \frac{N}{P}$
Normal Diametral Pitch (P _N)	Transverse Diametral Pitch (P) & Helix Angle (ψ)	$P_N = \frac{P}{\cos \psi}$
Normal Circular Tooth Thickness (τ)	Normal Diametral Pitch (P _N)	$\tau = \frac{1.5708}{P_N}$
Transverse Circular Pitch (p _t)	Diametral Pitch (P) (Transverse)	$p_t = \frac{\pi}{P}$
Normal Circular Pitch (p _n)	Transverse Circular Pitch (p)	$p_n = p_t \cos \psi$
Lead (L)	Pitch Diameter and Pitch Helix Angle	$L = \frac{\pi D}{\tan \psi}$

Transverse Vs. Normal Diametral Pitch for Boston 45° Helical Gears

P Transverse Diametral Pitch	P _N Normal Diametral Pitch
24	33.94
20	28.28
16	22.63
12	16.97
10	14.14
8	11.31
6	8.48

Helical Gear Lewis Formula

The beam strength of Helical Gears operating on *parallel shafts* can be calculated with the Lewis Formula revised to compensate for the difference between Spur and Helical Gears, with modified Tooth Form Factors Y.

$$W = \frac{SFY}{P_N} \left(\frac{600}{600 + V} \right)$$

W = Tooth Load, Lbs. (along the Pitch Line)
 S = Safe Material Stress (static) Lbs. per Sq. In. (Table III)
 F = Face Width, Inches
 Y = Tooth Form Factor (Table IV)
 P = Normal Diametral Pitch
 (Refer to Conversion Chart)
 D = Pitch Diameter
 V = Pitch Line Velocity, Ft. Per Min. = .262 x D x RPM

Table III – Values of Safe Static Stress (s)

Material	(s) Lb. per Sq. In.	
Bronze	10000	
Cast Iron	12000	
Steel	.20 Carbon (Untreated)	20000
	.20 Carbon (Case-hardened)	25000
	.40 Carbon (Untreated)	25000
	.40 Carbon (Heat-treated)	30000
.40 C. Alloy (Heat-treated)	40000	

Table IV – Values of Tooth Form Factor (Y)

FOR 14-1/2°PA – 45° HELIX ANGLE GEAR			
No. of Teeth	Factor Y	No. of Teeth	Factor Y
8	.295	25	.361
9	.305	30	.364
10	.314	32	.365
12	.327	36	.367
15	.339	40	.370
16	.342	48	.372
18	.345	50	.373
20	.352	60	.374
24	.358	72	.377

Horsepower and Torque

Max. allowable torque (T) that should be imposed on a gear will be the safe tooth load (W) multiplied by $\frac{D}{2}$ or $T = \frac{W \times D}{2}$

The safe horsepower capacity of the gear (at a given RPM) can be calculated from $HP = \frac{T \times RPM}{63,025}$ or directly from (W) and (V);

$$HP = \frac{WV}{33,000}$$

$$\text{For a known HP, } T = \frac{63025 \times HP}{RPM}$$

Engineering Information

Helical Gears

When Helical gears are operated on other than Parallel shafts, the tooth load is concentrated at a point, with the result that very small loads produce very high pressures. The sliding velocity is usually quite high and, combined with the concentrated pressure, may cause galling or excessive wear, especially if the teeth are not well lubricated. For these reasons, the tooth load which may be applied to such drives is very limited and of uncertain value, and is perhaps best determined by trial under actual operating conditions. If one of the gears is made of bronze, the contact area and thereby the load carrying capacity, may be increased, by allowing the gears to "run-in" in their operating position, under loads which gradually increase to the maximum expected.

Thrust Loads

As a result of the design of the Helical Gear tooth, an axial or thrust load is developed. Bearings must be adequate to absorb this load. The thrust load direction is indicated below. The magnitude of the thrust load is based on calculated Horsepower.

$$\text{Axial Thrust Load} = \frac{126,050 \times \text{HP}}{\text{RPM} \times \text{Pitch Diameter}}$$

Boston Helicals are all 45° Helix Angle, producing a tangential force equal in magnitude to the axial thrust load. A separating force is also imposed on the gear set based on calculated Horsepower.

$$\text{Separating Load} = \text{Axial Thrust Load} \times .386$$

Above formulae based on Boston 45° Helix Angle and 14-1/2° Normal Pressure Angle.

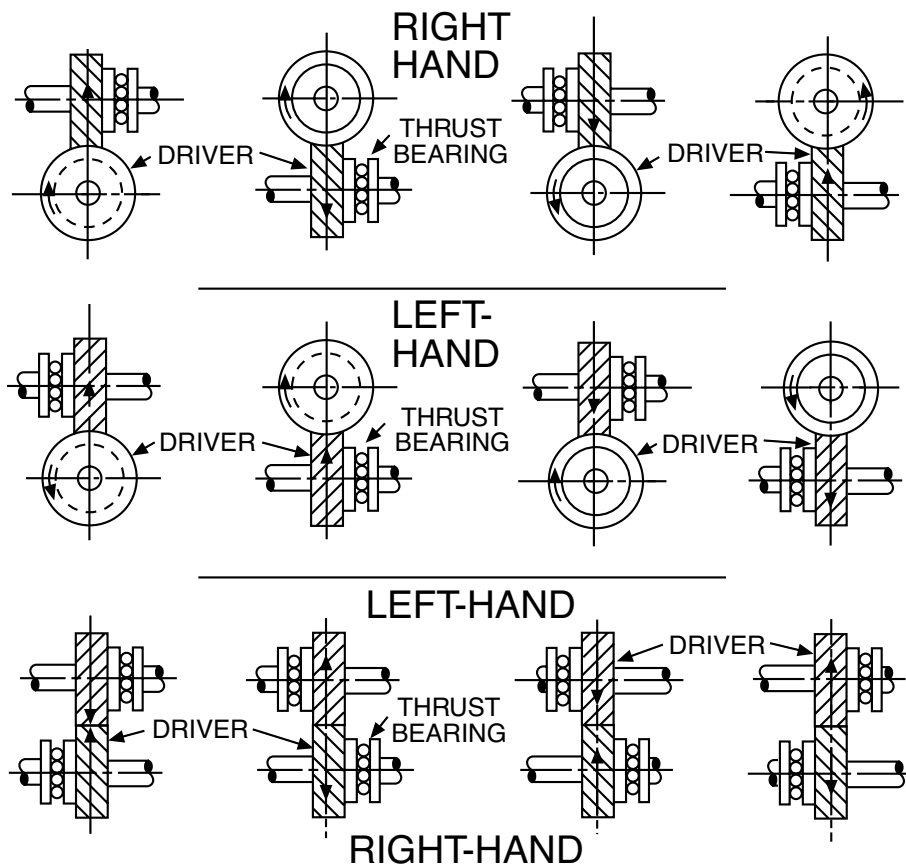

See page 118 for hardened and ground Thrust Washers.

Miter and Bevel Gears

Gear geometry for both straight and spiral tooth Miter and Bevel gears is of a complex nature and this text will not attempt to cover the topic in depth.

The basic tooth form is a modification to the involute form and is the common form used in production today. All Boston standard stock Miter and Bevel gears are manufactured with a 20° Pressure Angle. Bevel gears are made in accordance with A.G.M.A. specifications for long and short Addendum system for gears and pinions (pinion is cut long Addendum) which serves to reduce the amount of pinion tooth undercut and to nearly equalize the strength and durability of the gear set.

Nomenclature

Nomenclature may best be understood by means of graphic representation depicted below:

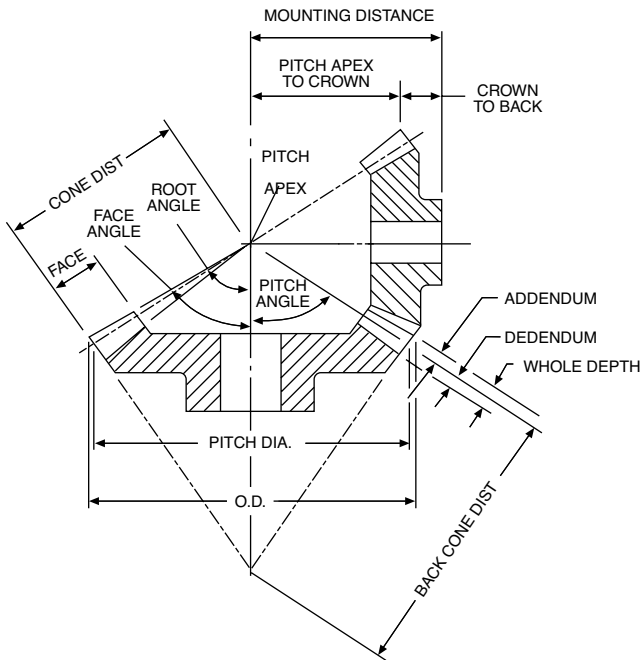

Stock gears are cut to operate on an exact Mounting Distance with the following average backlash:

Diametral Pitch	Backlash (Inches)
4	.008
5	.007
6	.006
8	.005
10	.004
12-20	.003
24-48	.002

Similar in nature to Helical gearing, Spiral Miters and Bevels must be run with a mating pinion or gear of opposite hand.

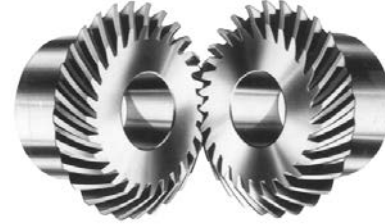

The teeth of a Right Hand gear lean to the right when the gear is placed on a horizontal surface.

The teeth of a Left Hand gear lean to the left when the gear is placed flat on a horizontal surface.

All Boston Spiral Miter and Bevel gears are made with 35° spiral angles with all pinions cut left hand.

Straight Tooth Miter and Bevel Gear Formulas

To Obtain	Having	Formula	
		Pinion	Gear
Pitch Diameter (D,d)	No. of Teeth and Diametral Pitch (P)	$d = \frac{n}{P}$	$D = \frac{N}{P}$
Whole Depth (h _t)	Diametral Pitch (P)	$h_t = \frac{2.188}{P} + .002$	$h_t = \frac{2.188}{P} + .002$
Addendum (a)	Diametral Pitch (P)	$a = \frac{1}{P}$	$a = \frac{1}{P}$
Dedendum (b)	Whole Depth (h _t) & Addendum (a)	$b = h_t - a$	$b = h_t - a$
Clearance	Whole Depth (h _t) & Addendum (a)	$c = h_t - 2a$	$c = h_t - 2a$
Circular Tooth Thickness (τ)	Diametral Pitch (P)	$\tau = \frac{1.5708}{P}$	$\tau = \frac{1.5708}{P}$
Pitch Angle	Number of Teeth In Pinion (N _p) and Gear (N _g)	$L_p = \tan^{-1} \left(\frac{N_p}{N_g} \right)$	$L_g = 90 - L_p$
Outside Diameter (D _o , d _o)	Pinion & Gear Pitch Diameter (D _p + D _g) Addendum (a) & Pitch Angle (L _p + L _g)	$d_o = D_p + 2a(\cos L_p)$	$D_o = D_g + 2a(\cos L_g)$

Engineering Information

Miter and Bevel Gears

Straight tooth bevel (and miter) gears are cut with generated tooth form having a localized lengthwise tooth bearing known as the "Coniflex"[®] tooth form. The superiority of these gears over straight bevels with full length tooth bearing, lies in the control of tooth contact. The localization of contact permits minor adjustment of the gears in assembly and allows for some displacement due to deflection under operating loads, without concentration of the load on the end of the tooth. This results in increased life and quieter operation.

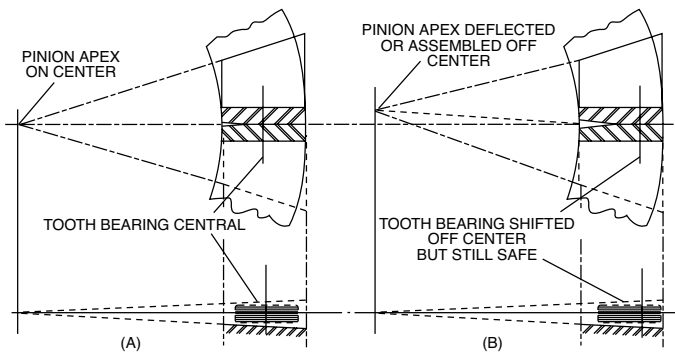
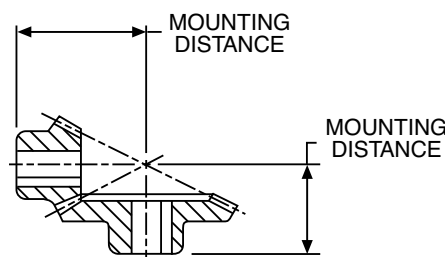
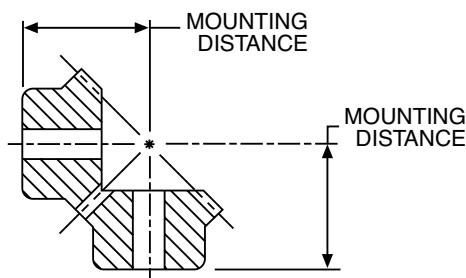

ILLUSTRATION OF LOCALIZED TOOTH BEARING IN STRAIGHT BEVEL CONIFLEX[®] GEARS

Boston Gear Bevel and Miter Gears will provide smooth, quiet operation and long life when properly mounted and lubricated. There are several important considerations in mounting these gears.

1. All standard stock bevel and miter gears must be mounted at right angles (90°) for proper tooth bearing.
2. Mounting Distance (MD) is the distance from the end of the hub of one gear to the center line of its mating gear. When mounted at the MD specified, the gears will have a proper backlash and the ends of the gear teeth will be flush with each other (see drawings).
3. All bevel and miter gears develop radial and axial thrust loads when transmitting power. See page 317. These loads must be accommodated by the use of bearings.



Incorrect

If Mounting Distance of one or both gears is made less than dimension specified, the teeth may bind. Excessive wear or breakage can result. Drawing below shows gears mounted incorrectly with the Mounting Distance too short for one gear.

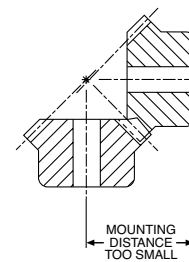

Incorrect

If Mounting Distance of either gear is made longer than dimension specified, as shown in drawing below, the gears will not be in full mesh on a common pitch line and may have excessive backlash or play, if great enough, can cause a sudden impulse or shock load in starting or reversing which might cause serious tooth damage.

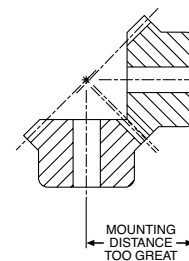

®Registered in the U.S. Patent Office.

Miter and Bevel Gears Tooth Strength (Straight Tooth)

The beam strength of Miter and Bevel gears (straight tooth) may be calculated using the Lewis Formula revised to compensate for the differences between Spur and Bevel gears. Several factors are often combined to make allowance for the tooth taper and the normal overhung mounting of Bevel gears.

$$W = \frac{SFY}{P} \left(\frac{600}{600 + V} \right) .75$$

- W = Tooth Load, Lbs. (along the Pitch Line)
- S = Safe Material Stress (static) Lbs. per Sq. In. (Table 1)
- F = Face Width, In.
- Y = Tooth Form Factor (Table I)
- P = Diametral Pitch
- D = Pitch Diameter
- V = Pitch Line Velocity, Ft. per Min. = .262 x D x RPM

TABLE I VALUES OF SAFE STATIC STRESS (s)

Material	(s) Lb. per Sq. In.	
Plastic	.5000	
Bronze	.10000	
Cast Iron	.12000	
Steel	.20 Carbon (Untreated)	.20000
	.20 Carbon (Case-hardened)	.25000
	.40 Carbon (Untreated)	.25000
	.40 Carbon (Heat-treated)	.30000
	.40 C. Alloy (Heat-treated)	.40000

TABLE II TOOTH FORM FACTOR (Y)

20°P.A.—LONG ADDENDUM PINIONS SHORT ADDENDUM GEARS

No. Teeth	Ratio											
	1		1.5		2		3		4		6	
Pinion	Pin.	Gear	Pin.	Gear	Pin.	Gear	Pin.	Gear	Pin.	Gear	Pin.	Gear
12	—	—	—	.345	.283	.355	.302	.358	.305	.361	.324	
14	—	.349	.292	.367	.301	.377	.317	.380	.323	.405	.352	
16	.333	.367	.311	.386	.320	.396	.333	.402	.339	.443	.377	
18	.342	.383	.328	.402	.336	.415	.346	.427	.364	.474	.399	
20	.352	.402	.339	.418	.349	.427	.355	.456	.386	.500	.421	
24	.371	.424	.364	.443	.368	.471	.377	.506	.405	—	—	
28	.386	.446	.383	.462	.386	.509	.396	.543	.421	—	—	
32	.399	.462	.396	.487	.402	.540	.412	—	—	—	—	
36	.408	.477	.408	.518	.415	.569	.424	—	—	—	—	
40	.418	—	—	.543	.424	.594	.434	—	—	—	—	

Horsepower and Torque

Max. allowable torque (T) that should be imposed on a gear will be the safe tooth load (W) multiplied by $\frac{D}{2}$ or $T = \frac{W \times D}{2}$

The safe horsepower capacity of the gear (at a given RPM) can be calculated from $HP = \frac{T \times RPM}{63,025}$ or directly from (W) and (V);

$$HP = \frac{WV}{33,000}$$

$$\text{For a known HP, } T = \frac{63025 \times HP}{RPM}$$

Thrust

The axial thrust loads developed by straight tooth miter and bevel gears always tend to separate the gears.



For Spiral Bevel and Miter Gears, the direction of axial thrust loads developed by the driven gears will depend upon the hand and direction of rotation. Stock Spiral Bevel pinions cut Left Hand only, Gears Right Hand only.

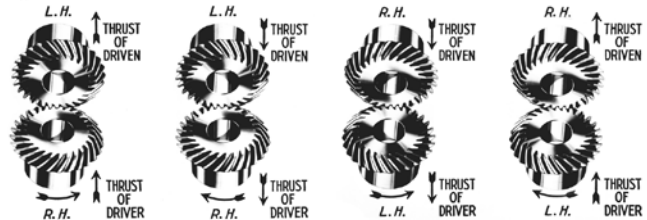

The magnitude of the thrust may be calculated from the formulae below, based on calculated HP, and an appropriate Thrust Bearing selected.

Straight Bevels and Miters

$$\text{Gear Thrust} = \frac{126,050 \times HP}{RPM \times \text{Pitch Diameter}} \times \tan \alpha \cos \beta$$

$$\text{Pinion Thrust} = \frac{126,050 \times HP}{RPM \times \text{Pitch Diameter}} \times \tan \alpha \sin \beta$$

Spiral Bevels and Miters

R.H. SPIRAL CLOCKWISE	$T_P = \frac{126,050 \times HP}{RPM \times D} \left(\frac{\tan \alpha \sin \beta}{\cos \gamma} - \tan \gamma \cos \beta \right)$
L.H. SPIRAL C. CLOCKWISE	$T_G = \frac{126,050 \times HP}{RPM \times D} \left(\frac{\tan \alpha \cos \beta}{\cos \gamma} + \tan \gamma \sin \beta \right)$
L.H. SPIRAL CLOCKWISE	$T_P = \frac{126,050 \times HP}{RPM \times D} \left(\frac{\tan \alpha \sin \beta}{\cos \gamma} + \tan \gamma \cos \beta \right)$
R.H. SPIRAL C. CLOCKWISE	$T_G = \frac{126,050 \times HP}{RPM \times D} \left(\frac{\tan \alpha \cos \beta}{\cos \gamma} + \tan \gamma \sin \beta \right)$

Thrust values for Pinions and Gears are given for four possible combinations.

α = Tooth Pressure Angle

β = 1/2 Pitch Angle

$$\text{Pitch Angle} = \tan^{-1} \left(\frac{N_P}{N_G} \right)$$

γ = Spiral Angle = 35°

Worms and Worm Gears

Boston standard stock Worms and Worm Gears are used for the transmission of motion and/or power between non-intersecting shafts at right angles (90°). Worm Gear drives are considered the smoothest and quietest form of gearing when properly applied and maintained. They should be considered for the following requirements:

- HIGH RATIO SPEED REDUCTION
- LIMITED SPACE
- RIGHT ANGLE (NON-INTERSECTING) SHAFTS
- GOOD RESISTANCE TO BACK DRIVING

General nomenclature having been applied to Spur and Helical gear types, may also be applied to Worm Gearing with the addition of Worm Lead and Lead Angle, Number of Threads (starts) and Worm Gear Throat diameter.

HOW TO TELL A LEFT-HAND OR RIGHT-HAND WORM OR WORM GEAR

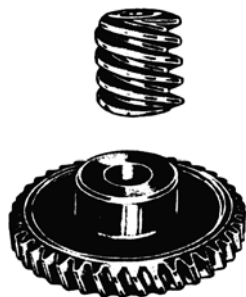

Threads of LEFT-HAND lean to the Left when standing on either end:

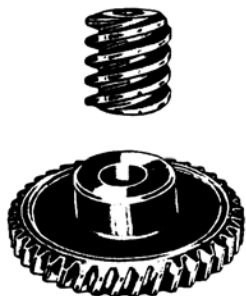

Threads of RIGHT-HAND lean to the Right when standing on either end:

Thrust Loads

As is true with Helical and Bevel gearing, Worm gearing, when operating, produces Thrust loading. The Chart below indicates the direction of thrust of Worms and Worm Gears when they are rotated as shown. To absorb this thrust loading, bearings should be located as indicated.

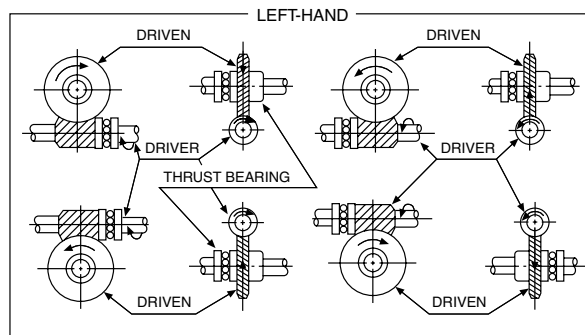
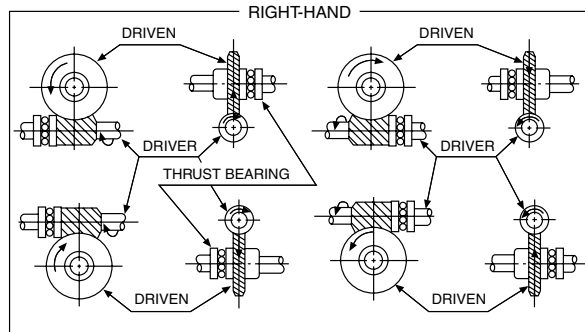

Efficiency

The efficiency of a worm gear drive depends on the lead angle of the worm. The angle decreases with increasing ratio and worm pitch diameter. For maximum efficiency the ratio should be kept low.

Due to the sliding action which occurs at the mesh of the Worm and Gear, the efficiency is dependent on the Lead Angle and the Coefficient of the contacting surface. A common formula for estimating efficiency of a given Worm Gear reduction is:

$$\text{EFFICIENCY} = E = \frac{\tan \gamma (1 - f \tan \gamma)}{f + \tan \gamma}$$

where γ = Worm Lead Angle
 f = Coefficient of Friction

For a Bronze Worm Gear and hardened Steel Worm, a Coefficient of Friction in the range of .03/.05 may be assumed for estimated value only.

Worm and Worm Gear Formulas

To Obtain	Having	Formula
Circular Pitch (p)	Diametral Pitch (P)	$p = \frac{3.1416}{P}$
Diametral Pitch (P)	Circular Pitch (p)	$P = \frac{3.1416}{p}$
Lead (of Worm) (L)	Number of Threads in Worm & Circular Pitch (p)	$L = p(\text{No. of Threads})$
Addendum (a)	Diametral Pitch (P)	$a = \frac{1}{P}$
Pitch Diameter (D) of Worm (D_w)	Outside Diameter (d_o) & Addendum (a)	$D_w = d_o - 2a$
Pitch Diameter of Worm Gear (D_g)	Circular Pitch (p) & Number of Teeth (N)	$D_g = \frac{N_{Gp}}{3.1416}$
Center Distance Between Worm & Worm Gear (CD)	Pitch Diameter of Worm (d_w) & Worm Gear (D_g)	$CD = \frac{d_w + D_g}{2}$
Whole Depth of Teeth (h_T)	Circular Pitch (p)	$h_T = .6866 p$
	Diametral Pitch (P)	$h_T = \frac{2.157}{P}$
Bottom Diameter of Worm (D_r)	Whole Depth (h_T) & Outside Diameter (d_w)	$d_r = d_o - 2h_T$
Throat Diameter of Worm Gear (D_T)	Pitch Diameter of Worm Gear (D) & Addendum (a)	$D_T = D_g + 2a$
Lead Angle of Worm (γ)	Pitch Diameter of Worm (D) & The Lead (L)	$\gamma = \tan^{-1} \left(\frac{L}{3.1416d} \right)$
Ratio	No. of Teeth on Gear (N_g) and Number of Threads on Worm	$\text{Ratio} = \frac{N_g}{\text{No. of Threads}}$
Gear O.D. (D_o)	Throat Dia. (D_T) and Addendum (a)	$D_o = D_T + .6a$

Self-Locking Ability

There is often some confusion as to the self-locking ability of a worm and gear set. Boston worm gear sets, under no condition should be considered to hold a load when at rest. The statement is made to cover the broad spectrum of variables effecting self-locking characteristics of a particular gear set in a specific application. Theoretically, a worm gear will not back drive if the friction angle is greater than the worm lead angle. However, the actual surface finish and lubrication may reduce this significantly. More important, vibration may cause motion at the point of mesh with further reduction in the friction angle.

Generally speaking, if the worm lead angle is less than 5°, there is reasonable expectation of self-locking. Again, no guarantee should be made and customer should be advised. If safety is involved, a positive brake should be used.

Worm Gear Back-Driving

This is the converse of self-locking and refers to the ability of the worm gear to drive the worm. The same variables exist, making it difficult to predict. However, our experience indicates that for a hardened worm and bronze gear properly manufactured, mounted and lubricated, back-driving capability may be expected, if the lead angle is greater than 11°. Again, no guarantee is made and the customer should be so advised.

Rating

The high rate of sliding friction that takes place at the mesh of the Worm and Gear results in a more complex method of rating these Gears as opposed to the other Gear types. Material factors, friction factors and velocity factors must all be considered and applied to reflect a realistic durability rating.

Engineering Information

Couplings

Alignment

Alignment of Boston couplings should be performed by the following steps to meet lateral and angular misalignment specifications below.

1. Align shafts and supports to give minimum lateral and angular misalignment.
2. Assemble coupling halves to shaft.
3. Slide couplings together and check lateral misalignment using straight edge and feeler gauge over coupling outside diameter. (On BF Series couplings, spider must be removed.) This should be within specifications below.
4. Lock couplings on shaft and check distance using feeler gauges between drive lug on one half and space between on other coupling half. Rotate coupling and check gap at a minimum of 3 other coupling positions. The difference between any two readings should be within specifications below.

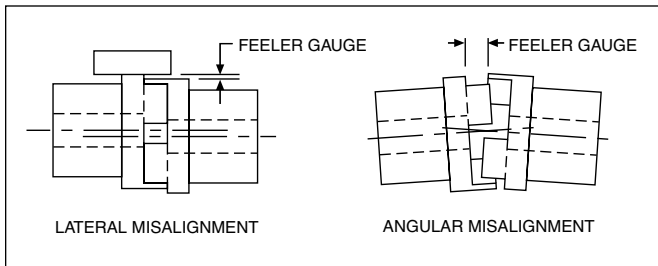

MISALIGNMENT TOLERANCES

Coupling Series	Lateral / Parallel	Angular
FC—Bronze Insert FC—Urethane Insert FC—Rubber Insert	.001 .002 .002	See Chart below
BF	.002	1-1/2°
BG (Shear Type)	1/32	2°
FA	.002	2°
FCP (Plastic)	.003	3°

FC Series ANGULAR MISALIGNMENT

Chart reflects maximum angular misalignment of 1-1/2° for rubber, 1° for urethane and 1/2° for bronze.

MAXIMUM READING DIFFERENTIAL

Size	Rubber	Insert Urethane	Bronze
FC12	.033	.022	.011
FC15	.039	.026	.013
FC20	.053	.035	.018
FC25	.066	.044	.022
FC30	.078	.052	.026
FC38	.097	.065	.032
FC45	.117	.078	.039

Mounting

A single universal joint (rotating at uniform speed) operating at an angle will introduce periodic variations of angular velocity to the driven shaft. These cyclic speed fluctuations (two per revolution) cause vibration, higher shaft stresses and bearing loads which will be more severe with larger angles of operation.

Universal Joints

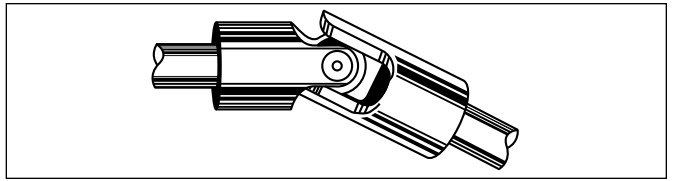

The detrimental effects of these rotational deviations can be reduced, and uniform speed restored by using two joints (and an intermediate shaft) to connect shafts at an angle or misaligned in a parallel direction.

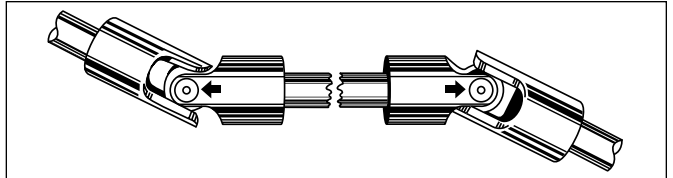

For connecting shafts in the same plane the joints should be arranged to operate at equal angles and with the bearing pins of the yokes on the intermediate shaft in line with each other.

Lubrication

PIN and BLOCK TYPE

These universal joints are not lubricated when shipped.

Many applications are considered severe when in harsh environments and when a combination of speed, dirt contamination and inaccessible locations make it impractical to maintain proper lubrication.

It is in these instances when the Boot Kits become a desirable alternative. For satisfactory performance, all booted joints should be used with a LITH-EP-000 grease for an ambient temperature range of 40° to 225°F.

VOLUME OF LUBRICATION FOR BOOTED JOINTS

Size	Volume (Ozs.)	Size	Volume (Ozs.)	Size	Volume (Ozs.)
37	.4	100	2.0	250	25.0
50	.5	125	3.5	300	30.0
62	.75	150	4.5	400	50.1
75	1.0	175	7.0		
87	1.5	200	15.0		

NOTE: Joints should be initially lubricated with a 90 weight oil before being packed with grease.

UJAS/UJNL SERIES

Universal joints are not lubricated when shipped.

Lubricate these joints with a Lith EP-2 grease or equivalent. The center cross of these joints holds a generous supply of lubricant which is fed to the bearings by centrifugal action. Light-duty, low-angle operation may require only occasional lubrication. For high-angle, high-speed operation or in extreme dirt or moist conditions, daily regreasing may be required.

HOW TO FIGURE HORSEPOWER AND TORQUE

To Obtain	Having	Formula
Velocity (V) Feet Per Minute	Pitch Diameter (D) of Gear or sprocket – Inches & Rev. Per Min. (RPM)	$V = 2618 \times D \times \text{RPM}$
Rev. per Min. (RPM)	Velocity (V) Ft. Per Min. & Pitch Diameter (D) of Gear or Sprocket – Inches	$\text{RPM} = \frac{V}{.268 \times D}$
Pitch Diameter (D) of Gear or Sprocket – Inches	Velocity (V) Ft. Per Min. & Rev. Per Min. (RPM)	$D = \frac{V}{.2618 \times \text{RPM}}$
Torque (T) In. Lbs.	Force (W) Lbs. & Radius (R) Inches	$T = W \times R$
Horsepower (HP)	Force (W) Lbs. & Velocity (V) Ft. Per Min.	$\text{HP} = \frac{W \times V}{33000}$
Horsepower (HP)	Torque (T) In Lbs. & Rev. per Min. (RPM)	$\text{HP} = \frac{T \times \text{RPM}}{63025}$
Torque (T) In. Lbs.	Horsepower (HP) & Rev. Per Min. (RPM)	$T = \frac{63025 \times \text{HP}}{\text{RPM}}$
Force (W) Lbs.	Horsepower (HP) & Velocity (V) Ft. Per Min.	$W = \frac{33000 \times \text{HP}}{V}$
Rev. Per Min. (RPM)	Horsepower (HP) & Torque (TP) In. Lbs.	$\text{RPM} = \frac{P}{T}$

POWER is the rate of doing work.

WORK is the exerting of a FORCE through a DISTANCE. ONE FOOT POUND is a unit of WORK. It is the WORK done in exerting a FORCE OF ONE POUND through a DISTANCE of ONE FOOT.

THE AMOUNT OF WORK done (Foot Pounds) is the FORCE (Pounds) exerted multiplied by the DISTANCE (Feet) through which the FORCE acts.

THE AMOUNT OF POWER used (Foot Pounds per Minute) is the WORK (Foot Pounds) done divided by the TIME (Minutes) required.

$$\text{POWER (Foot Pounds per Minute)} = \frac{\text{WORK (Ft. Lbs.)}}{\text{TIME (Minutes)}}$$

POWER is usually expressed in terms of HORSEPOWER.

HORSEPOWER is POWER (Foot Pounds per Minute) divided by 33,000.

$$\begin{aligned} \text{HORSEPOWER (HP)} &= \frac{\text{POWER (Ft. Lbs. per Minute)}}{33,000} \\ &= \frac{\text{WORK (Ft. Pounds)}}{33,000 \times \text{TIME (Min.)}} \\ &= \frac{\text{FORCE (Lbs.)} \times \text{DISTANCE (Feet)}}{33,000 \times \text{TIME (Min.)}} \end{aligned}$$

$$\text{HORSEPOWER (HP)} = \frac{\text{FORCE (Lbs.)} \times \text{DISTANCE (Feet)}}{33,000 \times \text{TIME (Min.)}}$$

STANDARD KEYWAYS & SETSCREW

Diam. of Hole	Standard Keyway		Recom- mended Setscrew
	W	D	
5/16 to 7/16"	3/32"	3/64"	10–32
1/2 to 9/16	1/8	1/16	1/4–20
5/8 to 7/8	3/16	3/32	5/16–18
15/16 to 1-1/4	1/4	1/8	3/8–16
1-5/16 to 1-3/8	5/16	5/32	7/16–14
1-7/16 to 1-3/4	3/8	3/16	1/2–13
1-13/16 to 2-1/4	1/2	1/4	9/16–12
2-5/16 to 20-3/4	5/8	5/16	5/8–11
2-13/16 to 3-1/4	3/4	3/8	3/4–10
3-5/16 to 3-3/4	7/8	7/16	7/8–9
3-13/16 to 4-1/2	1	1/2	1–8
4-9/16 to 5-1/2	1-1/4	7/16	1-1/8–7
5-9/16 to 6-1/2	1-1/2	1/2	1-1/4–6

FORMULA:

$$X = \sqrt{(D/2)^2 - (W/2)^2} + D + D/2$$

$$X^1 = 2X - D$$

EXAMPLE:

Hole 1"; Keyway 1/4" wide by 1/8" deep.
 $X = \sqrt{(1/2)^2 - (1/8)^2} + 1/8 + 1/2 = 1.109"$
 $X^1 = 2.218 - 1.000 = \mathbf{1.218"}\mathbf>"$

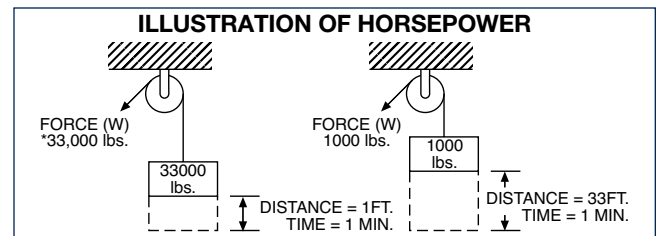

TORQUE (T) is the product of a FORCE (W) in pounds, times a RADIUS (R) in inches from the center of shaft (Lever Arm) and is expressed in Inch Pounds.

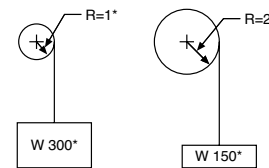

$$T = WR = 300 \times 1 = 300 \text{ In. Lbs.} \quad T = WR = 150 \times 2 = 300 \text{ In. Lbs.}$$

If the shaft is revolved, the FORCE (W) is moved through a distance, and WORK is done.

$$\text{WORK (Ft. Pounds)} = W \times \frac{2\pi R}{12} \times \text{No. of Rev. of Shaft.}$$

When this WORK is done in a specified TIME, POWER is used.

$$\text{POWER (Ft. Pounds per Min.)} = W \times \frac{2\pi R}{12} \times \text{RPM}$$

Since (1) HORSEPOWER = 33,000 Foot Pounds per minute

$$\text{HORSEPOWER (HP)} = W \times \frac{2\pi R}{12} \times \frac{\text{RPM}}{33,000} = \frac{W \times R \times \text{RPM}}{63,025}$$

but TORQUE (Inch Pounds) = FORCE (W) x RADIUS (R)

$$\text{Therefore HORSEPOWER (HP)} = \frac{\text{TORQUE (T)} \times (\text{RPM})}{63,025}$$

General

Mounting

SPUR & HELICAL

For proper functioning gears, gears must be accurately aligned and supported by a shaft and bearing system which maintains alignment under load. Deflection should not exceed .001 inch at the tooth mesh for general applications. The tolerance on Center Distance normally should be positive to avoid possibility of gear teeth binding. Tolerance value is dependent on acceptable system backlash. As a guide for average application, this tolerance might vary from .002 for Boston Gear's fine pitch gears to .005 for the coarsest pitch.

WORMS AND WORM GEAR

It is important that the mounting assures the central plane of the Worm gear passes essentially through the axis of the Worm. This can be accomplished by adjusting the Worm Gear axially. Boston Worm Gears are cut to close tolerancing of the Center Line of the Gear tooth to the flush side of the Gear. When properly mounted Worm Gears will become more efficient after initial break-in period.

HOW WORM GEARS "ADJUST" THEMSELVES

The gear in a worm gear reducer is made of a soft bronze material. Therefore, it can cold-work and wear-in to accommodate slight errors in misalignment.

Evolution of Contact in a Worm Gear

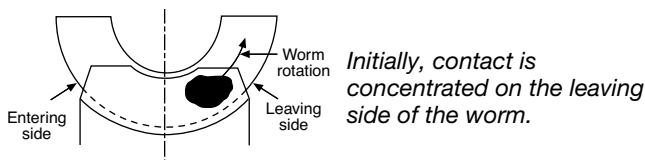

Initially, contact is concentrated on the leaving side of the worm.

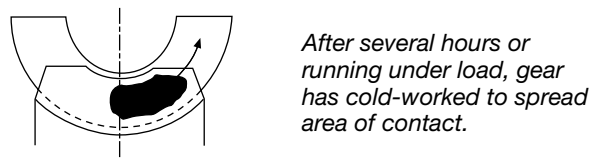

After several hours or running under load, gear has cold-worked to spread area of contact.

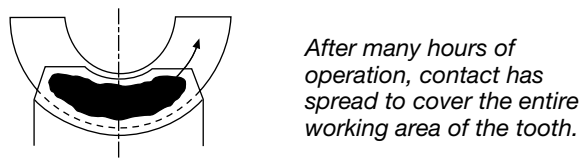

After many hours of operation, contact has spread to cover the entire working area of the tooth.

Alterations

Boston Gear Service Centers are equipped to alter catalog sprockets (rebore, keyway, setscrew, etc.). For customers, choosing to make their own alterations, the guidelines listed below should be beneficial. Alterations to hardened gears should not be made without consultation with factory.

In setting up for reboring the most important consideration is to preserve the accuracy of concentricity and lateral runout provided in the original product. There are several methods for accomplishing this. One procedure is: mount the part on an arbor, machine hub diameter to provide a true running surface, remove from arbor and chuck on the hub diameter, check face and bore runout prior to reboring. As a basic rule of thumb, the maximum bore should not exceed 60% of the Hub Diameter and depending on Key size should be checked for minimum wall thickness. A minimum of one setscrew diameter over a keyway is considered adequate.

Boston Gear offers a service for hardening stock sprockets. This added treatment can provide increased horsepower capacity with resultant longer life and/or reduction in size and weight.

Customers wishing to do the hardening operation should refer to "Materials" below for information.

Lubrication

The use of a straight mineral oil is recommended for most worm gear applications. This type of oil is applicable to gears of all materials, including non-metallic materials.

Mild E.P. (Extreme Pressure) lubricants may be used with Iron and Steel Gears. E.P. lubricants normally should be selected of the same viscosity as straight mineral oil, E.P. lubricants are not recommended for use with brass or bronze gears.

SAE80 or 90 gear oil should be satisfactory for splash lubricated gears. Where extremely high or low speed conditions are encountered, consult a lubricant manufacturer. Oil temperature of 150°F should not be exceeded for continuous duty applications. Temperatures up to 200°F can be safely tolerated for short periods of time.

Many specialty lubricants have been recently developed to meet the application demands of today's markets, including synthetics and both high and low temperature oils and greases. In those instances where Bath or Drip Feed is not practical, a moly-Disulphide grease may be used successfully, for low speed applications.

Materials

Boston Gear stock steel gears are made from a .20 carbon steel with no subsequent treatment. For those applications requiring increased wearability, Case-hardening produces a wear resistant, durable surface and a higher strength core. Carburizing and hardening is the most common process used. Several proprietary nitriding processes are available for producing an essentially distortion-free part with a relatively shallow but wear-resistant case. Boston stock worms are made of either a .20 or .45 carbon steel. Selection of material is based on size and whether furnished as hardened or untreated.

Stock cast iron gears are manufactured from ASTM-CLASS 30 cast iron to Boston Gear specifications. This provides a fine-grained material with good wear-resistant properties.

Bronze worm and helical gears are produced from several alloys selected for bearing and strength properties. Phosphor bronze is used for helicals and some worm gears (12P and coarser). Finer pitch worm gears are made from several different grades of bronze, dependent on size.

Non-metallic spur Gears listed in this Catalog are made from cotton reinforced phenolic normally referred to as Grade "C."

Plastic Gears listed are molded from either Delrin®, Acetal or Minlon®.

Styles

Boston Spur, Helical, and Worm Gears are carried in Plain, Web, or Spoke styles, as illustrated.

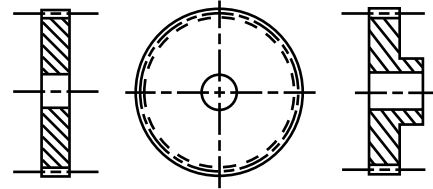

PLAIN – A

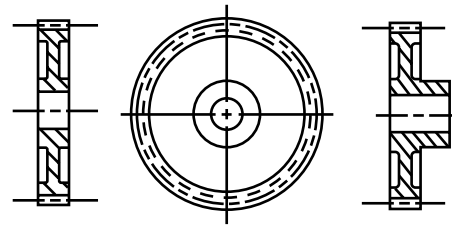

WEB – B

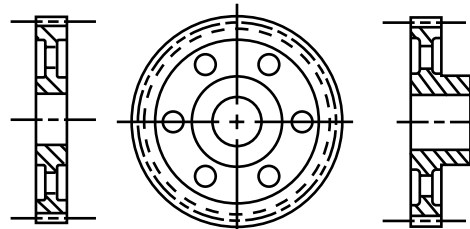

WEB WITH LIGHTNING HOLES – C

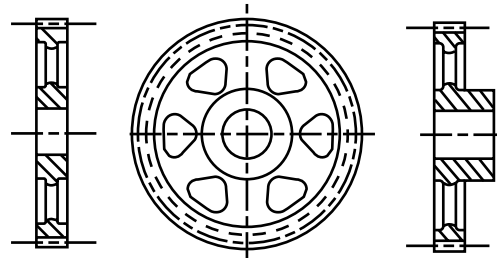

SPOKE – D

STANDARD KEYWAYS AND SETSCREWS

Diameter of Hole	Standard		Recommended Setscrew
	W	d	
5/16 to 7/16"	3/32"	3/64"	10-32
1/2 to 9/16	1/8	1/16	1/4-20
5/8 to 7/8	3/16	3/32	5/16-18
15/16 to 1-1/4	1/4	1/8	3/8-16
1-5/16 to 1-3/8	5/16	5/32	7/16-14
1-7/16 to 1-3/4	3/8	3/16	1/2-13
1-13/16 to 2-1/4	1/2	1/4	9/16-12
2-5/16 to 2-3/4	5/8	5/16	5/8-11
2-13/16 to 3-1/4	3/4	3/8	3/4-10
3-5/16 to 3-3/4	7/8	7/16	7/8-9
3-13/16 to 4-1/2	1	1/2	1-8
4-9/16 to 5-1/2	1-1/4	7/16	1-1/8-7
5-9/16 to 6-1/2	1-1/2	1/2	1-1/4-6

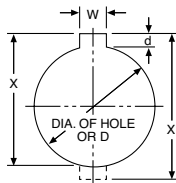

Formula:

$$X = \sqrt{(D/2)^2 - (W/2)^2} + d + D/2$$

$$X^1 = 2X - D$$

Example:

Hole 1"; Keyway 1/4" wide by 1/8" deep.

$$X = \sqrt{(1/2)^2 - (1/8)^2} + 1/8 + 1/2 = \mathbf{1.109"}$$

$$X^1 = 2.218 - 1.000 = \mathbf{1.218"}$$

Engineering Information

Sprockets

Alterations

Boston Gear Service Centers are equipped to alter catalog sprockets (rebore, keyway, setscrew, etc.). For customers, choosing to make their own alterations, the guidelines listed below should be beneficial. Alterations to hardened gears should not be made without consultation with factory.

In setting up for reboring the most important consideration is to preserve the accuracy of concentricity and lateral runout provided in the original product. There are several methods for accomplishing this. One procedure is: mount the part on an arbor, machine hub diameter to provide a true running surface, remove from arbor and chuck on the hub diameter, check face and bore runout prior to reboring. As a basic rule of thumb, the maximum bore should not exceed 60% of the Hub Diameter and depending on Key size should be checked for minimum wall thickness. A minimum of one setscrew diameter over a keyway is considered adequate.

Boston Gear offers a service for hardening stock sprockets. This added treatment can provide increased horsepower capacity with resultant longer life and/or reduction in size and weight.

Customers wishing to do the hardening operation should refer to "Materials" below for information.

Materials

Plastic

Plastic sprockets listed are molded from Nylatron GS.

Steel

Type B one-piece sprockets are furnished in a free-machining, low carbon steel.

Plate sprockets (Type A) and two-piece construction (Type B) are made of low carbon steel (basically AISI 1020).

1/4" pitch (Type B) up to 20 teeth is furnished from sintered metal powder conforming to ASTM-B-426-70 Grade 1, Type III with hardness of RB60 MIN.

Stainless Steel

1/4, 3/8 and 1/2" Pitches stock bore, single strand are furnished from 303 free-machining Stainless Steel.

Cast Iron

Block Chain Sprockets are furnished in Cast Iron for 9 through 12 teeth, which conforms to ASTM-A48-Class 30 Cast Iron, providing a fine-grained material with good wear resistant properties.

Overhung Load

Overhung load is introduced on a shaft by the sprocket, gear, or belt from which the shaft is driven. A shaft driven by a properly installed flexible coupling would not have an overhung load.

The magnitude of the overhung load is determined by the load at the driving or driven member and the distance this member is from the nearest shaft support bearing. Overhung load will reduce the safe power transmission capacity of any shaft, therefore, every effort must be made to reduce this load. There are two ways to reduce this load (1) reduce the support distance or (2) increase the diameter of the driving and driven member. In most cases, increasing the size of a drive is not possible and therefore, all effort should be made to reduce the support distance.

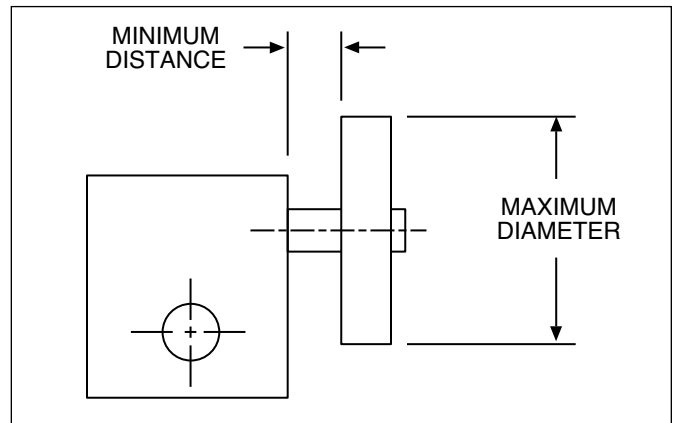

FORMULA:

$$X = \sqrt{(D/2)^2 - (W/2)^2} + D + D/2$$

$$X' = 2X - D$$

EXAMPLE:

Hole 1"; Keyway 1/4" wide by 1/8" deep.

$$X = \sqrt{(1/2)^2 - (1/8)^2} + 1 + 1/2 = 1.109"$$

$$X' = 2.218 - 1.000 = \mathbf{1.218"}\mathbf{}$$

STANDARD KEYWAYS AND SETSCREWS

Diameter of Hole	Standard Keyway		Recommended Setscrew
	W	D	
5/16 to 7/16"	3/32"	3/64"	10-32
1/2 to 9/16	1/8	1/16	1/4-20
5/8 to 7/8	3/16	3/32	5/16-18
15/16 to 1-1/4	1/4	1/8	3/8-16
1-5/16 to 1-3/8	5/16	5/32	7/16-14
1-7/16 to 1-3/4	3/8	3/16	1/2-13
1-13/16 to 2-1/4	1/2	1/4	9/16-12
2-5/16 to 2-3/4	5/8	5/16	5/8-11
2-13/16 to 3-1/4	3/4	3/8	3/4-10
3-5/16 to 3-3/4	7/8	7/16	7/8-9
3-13/16 to 4-1/2	1	1/2	1-8
4-9/16 to 5-1/2	1-1/4	7/16	1-1/8-7
5-9/16 to 6-1/2	1-1/2	1/2	1-1/4-6

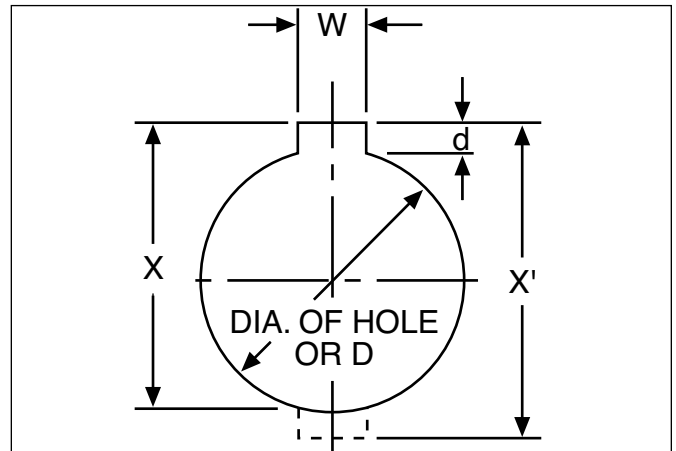

Sprocket Diameters for ANSI Standard Series

Number of Teeth	1/4" Pitch—No. 25 .130" Roller Diameter			3/8" Pitch—No. 35 .200" Roller Diameter			1/2" Pitch—No. 40 .312" Roller Diameter			1/2" Pitch—No. 41 .306" Roller Diameter		
	Pitch Diameter	Outside Diameter	Bottom Diameter	Pitch Diameter	Outside Diameter	Bottom Diameter	Pitch Diameter	Outside Diameter	Bottom Diameter	Pitch Diameter	Outside Diameter	Bottom Diameter
9	0.731	0.83	0.601	1.096	1.26	0.896	1.462	1.67	1.149	1.462	1.67	1.156
10	0.809	0.91	0.679	1.214	1.38	1.014	1.618	1.84	1.305	1.618	1.84	1.312
11	0.887	1.00	0.757	1.331	1.50	1.131	1.775	2.00	1.462	1.775	2.00	1.469
12	0.966	1.08	0.836	1.449	1.63	1.249	1.932	2.17	1.619	1.932	2.17	1.626
13	1.045	1.16	0.915	1.567	1.75	1.367	2.089	2.33	1.776	2.089	2.33	1.783
14	1.124	1.24	0.994	1.685	1.87	1.485	2.247	2.49	1.934	2.247	2.49	1.941
15	1.203	1.32	1.073	1.804	1.99	1.604	2.405	2.65	2.092	2.405	2.65	2.099
16	1.282	1.40	1.152	1.922	2.11	1.722	2.563	2.81	2.250	2.563	2.81	2.257
17	1.361	1.48	1.231	2.041	2.23	1.841	2.721	2.98	2.408	2.721	2.98	2.415
18	1.440	1.56	1.310	2.160	2.35	1.960	2.879	3.14	2.566	2.879	3.14	2.573
19	1.519	1.64	1.389	2.278	2.47	2.078	3.038	3.30	2.725	3.038	3.30	2.732
20	1.598	1.72	1.468	2.397	2.59	2.197	3.196	3.46	2.883	3.196	3.46	2.890
21	1.678	1.80	1.548	2.516	2.71	2.316	3.355	3.62	3.042	3.355	3.62	3.049
22	1.757	1.88	1.627	2.635	2.83	2.435	3.513	3.78	3.200	3.513	3.78	3.207
23	1.836	1.96	1.706	2.754	2.95	2.554	3.672	3.94	3.359	3.672	3.94	3.366
24	1.915	2.04	1.785	2.873	3.07	2.673	3.831	4.10	3.518	3.831	4.10	3.525
25	1.995	2.12	1.865	2.992	3.19	2.792	3.989	4.26	3.676	3.989	4.26	3.683
26	2.074	2.20	1.944	3.111	3.31	2.911	4.148	4.42	3.835	4.148	4.42	3.842
27	2.154	2.28	2.024	3.230	3.43	3.030	4.307	4.58	3.994	4.307	4.58	4.001
28	2.233	2.36	2.103	3.349	3.55	3.149	4.466	4.74	4.153	4.466	4.74	4.159
30	2.392	2.52	2.262	3.588	3.79	3.388	4.783	5.06	4.470	4.783	5.06	4.477
31	2.471	2.60	2.341	3.707	3.91	3.507	4.942	5.22	4.629	4.942	5.22	4.636
32	2.551	2.68	2.421	3.826	4.03	3.626	5.101	5.38	4.789	5.101	5.38	4.794
33	2.630	2.76	2.500	3.945	4.15	3.745	5.260	5.54	4.947	5.260	5.54	4.954
34	2.710	2.84	2.580	4.064	4.27	3.864	5.419	5.70	5.106	5.419	5.70	5.113
35	2.789	2.92	2.659	4.183	4.39	3.983	5.578	5.86	5.265	5.578	5.86	5.272
36	2.869	3.00	2.739	4.303	4.51	4.103	5.737	6.02	5.424	5.737	6.02	5.431
38	3.028	3.16	2.898	4.541	4.75	4.341	6.055	6.33	5.742	6.055	6.33	5.749
39	3.107	3.24	2.977	4.660	4.87	4.460	6.214	6.49	5.901	6.214	6.49	5.908
40	3.187	3.32	3.056	4.779	4.99	4.579	6.373	6.65	6.060	6.373	6.65	6.017
41	3.266	3.40	3.136	4.899	5.11	4.699	6.532	6.81	6.219	6.532	6.81	6.226
42	3.346	3.48	3.216	5.018	5.23	4.818	6.691	6.97	6.378	6.691	6.97	6.385
44	3.505	3.64	3.375	5.257	5.47	5.057	7.009	7.29	6.696	7.009	7.29	6.703
45	3.584	3.72	3.454	5.376	5.59	5.176	7.168	7.45	6.855	7.168	7.45	6.862
48	3.823	3.96	3.693	5.734	5.95	5.534	7.645	7.93	7.332	7.645	7.93	7.339
52	4.141	4.28	4.011	6.211	6.43	6.011	8.281	8.57	7.968	8.281	8.57	7.975
54	4.300	4.44	4.170	6.449	6.66	6.249	8.599	8.89	8.286	8.599	8.89	8.294
56	4.459	4.60	4.329	6.688	6.90	6.488	8.917	9.20	8.605	8.917	9.20	8.611
60	4.777	4.92	4.647	7.165	7.38	6.965	9.554	9.84	9.241	9.554	9.84	9.246
64	5.095	5.23	4.965	7.643	7.86	7.443	10.190	10.48	9.877	10.190	10.48	9.883
65	5.175	5.31	5.045	7.762	7.98	7.562	10.349	10.64	10.036	10.349	10.64	10.044
66	5.254	5.39	5.124	7.881	8.10	7.681	10.508	10.80	10.195	10.508	10.80	10.202
70	5.572	5.71	5.442	8.358	8.58	8.158	11.145	11.43	10.832	11.145	11.43	10.840
72	5.732	5.87	5.602	8.597	8.81	8.397	11.463	11.75	11.150	11.463	11.75	11.156
80	6.368	6.51	6.238	9.552	9.77	9.352	12.736	13.03	12.423	12.736	13.03	12.430
84	6.686	6.83	6.556	10.029	10.25	9.829	13.372	13.66	13.059	13.372	13.66	13.067
96	7.641	7.78	7.511	11.461	11.68	11.261	15.281	15.57	14.969	15.281	15.57	14.976

Engineering Information

Sprocket Diameters for ANSI Standard Series Hubs

No. of Teeth	5/8" Pitch—No. 50 .400" Roller Diameter			3/4" Pitch—No. 60 .468" Roller Diameter			1" Pitch—No. 80 .625" Roller Diameter		
	Pitch Diameter	Outside Diameter	Bottom Diameter	Pitch Diameter	Outside Diameter	Bottom Diameter	Pitch Diameter	Outside Diameter	Bottom Diameter
9	1.87	2.09	1.427	2.193	2.51	1.724	2.924	3.35	2.299
10	2.023	2.30	1.623	2.427	2.76	1.958	3.236	3.68	2.611
11	2.218	2.50	1.818	2.662	3.00	2.193	2.549	4.01	2.924
12	2.415	2.71	2.015	2.898	3.25	2.429	3.864	4.33	3.239
13	2.612	2.91	2.212	3.134	3.49	2.665	4.179	4.66	3.554
14	2.809	3.11	2.409	3.371	3.74	2.902	4.494	4.98	3.869
15	3.006	3.32	2.606	3.607	3.98	3.138	4.180	5.31	4.185
16	3.204	3.52	2.804	3.844	4.22	3.375	5.126	5.63	4.501
17	3.401	3.72	3.001	4.082	4.46	3.613	5.442	5.95	4.817
18	3.599	3.92	3.199	4.319	4.70	3.850	5.759	6.27	5.134
19	3.797	4.12	3.397	4.557	4.95	4.088	6.076	6.59	5.451
20	3.995	4.32	3.595	4.794	5.19	4.325	6.393	6.91	5.768
21	4.193	4.52	3.793	5.032	5.43	4.563	6.710	7.24	6.085
22	4.392	4.72	3.992	5.270	5.67	4.801	7.027	7.56	6.402
23	4.590	4.92	4.190	5.508	5.91	5.039	7.344	7.88	6.719
24	4.788	5.12	4.388	5.746	6.15	5.277	7.661	8.20	7.036
25	4.987	5.32	4.587	5.984	6.39	5.515	7.979	8.52	7.354
26	5.185	5.52	4.785	6.222	6.63	5.753	8.296	8.84	7.671
28	5.582	5.92	5.182	6.699	7.11	6.230	8.931	9.48	8.306
30	5.979	6.32	5.579	7.175	7.59	6.706	9.567	10.11	8.942
32	6.376	6.72	5.976	7.652	8.07	7.183	10.202	10.75	9.577
34	6.774	7.12	6.374	8.128	8.54	7.659	10.838	11.39	10.213
35	6.972	7.32	6.572	8.367	8.78	7.898	11.156	11.71	10.531
36	7.171	7.52	6.771	8.605	9.02	8.136	11.474	12.03	10.849
37	7.370	7.72	6.970	8.844	9.26	8.375	11.792	12.35	11.167
38	7.569	7.92	7.169	9.082	9.50	8.613	12.110	12.67	11.485
40	7.966	8.32	7.566	9.559	9.98	9.090	12.746	13.31	12.121
42	8.363	8.72	7.963	10.036	10.46	9.567	13.382	13.94	12.757
44	8.761	9.11	8.361	10.513	10.94	10.044	14.018	14.58	13.393
45	8.960	9.31	8.560	10.752	11.18	10.283	14.336	14.90	13.711
48	9.556	9.91	9.156	11.467	11.89	10.998	15.290	15.86	14.665
49	9.755	10.11	9.355	11.706	12.13	11.237	15.608	16.18	14.983
50	9.954	10.31	9.554	11.945	12.37	11.476	15.926	16.50	15.301
52	10.351	10.71	9.951	12.422	12.85	11.953	16.562	17.13	15.937
54	10.749	11.11	10349	12.899	13.33	12.430	17.198	17.77	16.573
56	11.147	11.50	10.747	13.376	13.81	12.907	17.835	18.41	17.210
60	11.942	12.30	11.542	13.330	14.76	13.861	19.107	19.68	18.482
64	12.738	13.10	12.338	15.285	15.72	14.816	20.380	20.96	19.755
70	13.931	14.29	13.531	16.717	17.15	16.248	22.289	22.87	21.664
72	14.329	14.69	13.929	17.194	17.63	16.725	22.926	23.50	22.301
76	15.124	15.49	14.724	18.149	18.58	17.680	24.199	24.78	23.574
80	15.920	16.28	15.520	19.103	19.54	18.634	25.471	26.05	24.846
84	16.715	17.08	16.315	20.058	20.49	19.589	26.744	27.33	26.119
90	17.909	18.27	17.509	21.490	21.93	21.021	28.654	29.24	28.029
96	19.102	19.47	18.702	22.922	23.36	22.453	30.563	31.15	29.938

Horsepower & Torque Capacity of Shafting

Diameter	Shaft Horsepower Based on Pure Torsion at 10,000 PSI Maximum Shear Stress							Torque Capacity (Lb. Ins.) Based on 10,000 PSI Shear Stress
	30	50	100	175	690	1150	1750	
3/8	0.049	0.082	0.164	0.287	1.13	1.88	2.87	103
7/16	0.078	0.130	0.261	0.456	1.79	2.99	4.56	164
1/2	0.117	0.194	0.389	0.681	2.68	4.47	6.80	245
9/16	0.166	0.277	0.554	0.969	3.82	6.36	9.69	349
5/8	0.228	0.380	0.760	1.32	5.24	8.73	13.2	479
11/16	0.303	0.506	1.01	1.76	6.97	11.6	17.6	637
3/4	0.394	0.656	1.31	2.29	9.05	15.0	22.9	827
13/16	0.501	0.834	1.66	2.92	11.5	19.1	29.2	1052
7/8	0.625	1.04	2.08	3.64	14.3	23.9	36.4	1314
15/16	0.769	1.28	2.56	4.48	17.6	29.4	44.3	1616
1	0.933	1.55	3.11	5.44	21.4	35.7	54.4	1961
1-1/16	1.12	1.86	3.73	6.53	25.7	42.9	65.3	2352
1-1/8	1.32	2.21	4.43	7.75	30.5	50.9	77.5	2792
1-3/16	1.56	2.60	5.21	9.11	35.9	59.9	91.1	3283
1-1/4	1.82	3.03	6.07	10.6	41.9	69.8	106	3830
1-5/16	2.11	3.51	7.03	12.3	48.5	80	123	4433
1-3/8	2.42	4.04	8.08	11.1	55.8	93	141	5097
1-7/16	2.77	4.62	9.24	16.1	63.7	106	161	5824
1-1/2	3.15	5.25	10.5	18.3	72.4	120	183	6618
1-9/16	3.56	5.93	11.8	20.7	81.8	136	207	7480
1-5/8	4.00	6.67	13.3	23.3	92.1	153	233	8414
1-11/16	4.48	7.47	14.9	26.1	103.1	171	261	9422
1-3/4	5.00	8.33	16.6	29.1	115.0	191	291	10509
1-13/16	5.55	9.26	18.5	32.4	127.8	213	324	11675
1-7/8	6.15	10.2	20.5	35.8	141.5	235	358	12925
1-15/16	6.78	11.3	22.6	39.6	156.1	260	396	14261
2	7.46	12.4	24.8	43.5	171.7	286	435	15686
2-1/16	8.18	13.6	27.2	47.7	188.3	313	477	17203
2-1/8	8.95	14.9	29.8	52.2	206.0	343	522	18815
2-3/16	9.77	16.2	32.5	56.9	224.7	374	569	20525
2-1/4	10.6	17.7	35.4	62.0	244.5	407	620	22335
2-5/16	11.5	19.2	38.4	67.3	265.4	442	673	24248
2-3/8	12.5	20.8	41.6	72.9	287.6	479	729	26268
2-7/16	13.5	22.5	45.0	78.8	310.9	518	788	29396
2-1/2	14.5	24.3	48.6	85.0	335.1	559	850	30637
2-9/16	15.7	26.1	52.3	91.6	361.2	602	916	32993
2-5/8	16.8	28.1	56.2	98.4	388.3	647	984	35466

The above table is computed based on a torsional stress of 10,000 PSI. For applications involving bending moments (gears, sprockets, etc.) the horsepower capacity must be reduced accordingly.

The stress level of 10,000 PSI is representative of medium carbon steel shafting. For other materials, a correction must be made accordingly.

Engineering Information

Temperature Conversion Table

Degrees Celcius "C"; Degrees Fahrenheit "F"

Degree C.	Degree F.	Degree C.	Degree F.	Degree C.	Degree F.	Degree C.	Degree F.	Degree C.	Degree F.
-40	-40.0	8	46.4	56	132.8	104	219.2	152	305.6
-39	-38.2	9	48.2	57	134.6	105	221.0	153	307.4
-38	-36.4	10	50.0	58	136.4	106	222.8	154	309.2
-37	-34.6	11	51.8	59	138.2	107	224.6	155	311.0
-36	-32.8	12	53.6	60	140.0	108	226.4	156	312.8
-35	-31.0	13	55.4	61	141.8	109	228.2	157	314.6
-34	-29.2	14	57.2	62	143.6	110	230.0	158	316.4
-33	-27.4	15	59.0	63	145.4	111	231.8	159	318.2
-32	-25.6	16	60.8	64	147.2	112	233.6	160	320.0
-31	-23.8	17	62.6	65	149.0	113	235.4	161	321.8
-30	-22.0	18	64.4	66	150.8	114	237.2	162	323.6
-29	-20.2	19	66.2	67	152.6	115	239.0	163	325.4
-28	-18.4	20	68.0	68	154.4	116	240.8	164	327.2
-27	-16.6	21	69.8	69	156.2	117	242.6	165	329.0
-26	-14.8	22	71.6	70	158.0	118	244.4	166	330.8
-25	-13.0	23	73.4	71	159.8	119	246.2	167	332.6
-24	-11.2	24	75.2	72	161.6	120	248.0	168	334.4
-23	- 9.4	25	77.0	73	163.4	121	249.8	169	336.2
-22	- 7.6	26	78.8	74	165.2	122	251.6	170	338.0
-21	- 5.8	27	80.6	75	167.0	123	253.4	171	339.8
-20	- 4.0	28	82.4	76	168.8	124	255.2	172	341.6
-19	- 2.2	29	84.2	77	170.6	125	257.0	173	343.4
-18	- 0.4	30	86.0	78	172.4	126	258.8	174	345.2
-17	+ 1.4	31	87.8	79	174.2	127	260.6	175	347.0
-16	3.2	32	89.6	80	176.0	128	262.4	176	348.8
-15	5.0	33	91.4	81	177.8	129	264.2	177	350.6
-14	6.8	34	93.2	82	179.6	130	266.0	178	352.4
-13	8.6	35	95.0	83	181.4	131	267.8	179	354.2
-12	10.4	36	96.8	84	183.2	132	269.6	180	356.0
-11	12.2	37	98.6	85	185.0	133	271.4	181	357.8
-10	14.0	38	100.4	86	186.8	134	273.2	182	359.6
- 9	15.8	39	102.2	87	188.6	135	275.0	183	361.4
- 8	17.6	40	104.0	88	190.4	136	276.8	184	363.2
- 7	19.4	41	105.8	89	192.2	137	278.6	185	365.0
- 6	21.2	42	107.6	90	194.0	138	280.4	186	366.8
- 5	23.0	43	109.4	91	195.8	139	282.2	187	368.6
- 4	24.8	44	111.2	92	197.6	140	284.0	188	370.4
- 3	26.6	45	113.0	93	199.4	141	285.8	189	372.2
- 2	28.4	46	114.8	94	201.2	142	287.6	190	374.0
- 1	30.2	47	116.6	95	203.0	143	289.4	191	375.8
0	32.0	48	118.4	96	204.8	144	291.2	192	377.6
+ 1	33.8	49	120.2	97	206.6	145	293.0	193	379.4
2	35.6	50	122.0	98	208.4	146	294.8	194	381.2
3	37.4	51	123.8	99	210.2	147	296.6	195	383.0
4	39.2	52	125.6	100	212.0	148	298.4	196	384.8
5	41.0	53	127.4	101	213.8	149	300.2	197	386.6
6	42.8	54	129.2	102	215.6	150	302.0	198	388.4
7	44.5	55	131.0	103	217.4	151	303.8	199	390.2

FRACTION – DECIMAL – MILLIMETER

Fraction Inches	Inch Decimal Equivalent	Millimeter Equivalent	Fraction Inches	Inch Decimal Equivalent	Millimeter Equivalent
1/64	.0156	.397	33/64	.5156	13.097
1/32	.0312	.794	17/32	.5312	13.494
3/64	.0469	1.191	35/64	.5469	13.891
1/16	.0625	1.588	9/16	.5625	14.288
5/64	.0781	1.984	37/64	.5781	14.684
3/32	.0937	2.381	19/32	.5937	15.081
7/64	.1094	2.778	39/64	.6094	15.478
1/8	.1250	3.175	5/8	.6250	15.875
9/64	.1406	3.572	41/64	.6406	16.272
5/32	.1562	3.969	21/32	.6562	16.669
11/64	.1719	4.366	43/64	.6719	17.066
3/16	.1875	4.763	11/16	.6875	17.463
13/64	.2031	5.159	45/64	.7031	17.859
7/32	.2187	5.556	23/32	.7187	18.256
15/64	.2344	5.953	47/64	.7344	18.653
1/4	.2500	6.350	3/4	.7500	19.050
17/64	.2656	6.747	49/64	.7656	19.447
9/32	.2812	7.144	25/32	.7812	19.844
19/64	.2969	7.541	51/64	.7969	20.241
5/16	.3125	7.938	13/16	.8125	20.638
21/64	.3281	8.334	53/64	.8281	21.034
11/32	.3437	8.731	27/32	.8437	21.431
23/64	.3594	9.128	55/64	.8594	21.828
3/8	.3750	9.525	7/8	.8750	22.225
25/64	.3906	9.922	57/64	.8906	22.622
13/32	.4062	10.319	29/32	.9062	23.019
27/64	.4219	10.716	59/64	.9219	23.416
7/16	.4375	11.113	15/16	.9375	23.813
29/64	.4531	11.509	61/64	.9531	24.209
15/32	.4687	11.906	31/32	.9687	24.606
31/64	.4844	12.303	63/64	.9844	25.003
1/2	.5000	12.700	1	1.0000	25.400

MILLIMETER – INCHES

Millimeters	Inches
1	.0394
2	.0787
3	.1181
4	.1575
5	.1968
6	.2362
7	.2756
8	.3150
9	.3543
10	.3937
11	.4331
12	.4724
13	.5118
14	.5512
15	.5905
16	.6299
17	.6693
18	.7087
19	.7480
20	.7874
21	.8268
22	.8661
23	.9055
24	.9449
25	.9842
26	1.0236
27	1.0630
28	1.1024
29	1.1417
30	1.1811

Engineering Information

Metric Conversion Chart

Area

Multiply	By	To Obtain
Millimeters ²	.00155	inches ²
Centimeters ²	.155	inches ²
Meters ²	10.76	feet ²
Inches ²	645.16	millimeters ²
Inches ²	6.452	centimeters ²
Feet ²	929.03	centimeters ²
Feet ²	.0929	meters ²

Density

Multiply	By	To Obtain
lg/cm ³	.03613	lb/in ³
lg/cm ³	62.43	lb/in ³
lb/in ³	27.68	gr/cm ³
lb/ft ³	.016	g/cm ³
lb/ft ³	16.02	Kg/m ³

Power

Multiply	By	To Obtain
Joule/sec	.001341	Horsepower
Kilocalorie/hour	3.967	BTW/hour
Horsepower	.33000	ft-lb/min
Horsepower	746	watts
BTU/hour	.2521	kilocalorie/hour

Length

Multiply	By	To Obtain
Millimeter	.03937	inch
Centimeter	.3937	inch
Meter	39.37	inch
Inch	2.54	centimeter
Feet	30.48	centimeter
Feet	.3048	meter

Volume

Multiply	By	To Obtain
Centimeter ³	.0610	inches ³
Centimeter ³	.034	fluid ounce
Liter	61.02	inches ³
Liter	.0353	feet ³
Liter	.264	U.S. gallon
Inch ³	16.39	centimeter ³
Feet ³	28.32	liter
Gallon	3.785	liter

Weight

Multiply	By	To Obtain
Gram	.03527	ounce
Kilogram	35.27	ounce
Kilogram	2.205	pounds
Ounce	28.35	gram
Pound	453.6	grams

Torque

Multiply	By	To Obtain
Newton-meter	8.84	in-lb
in-lb	.113	Newton-meter

Velocity

Multiply	By	To Obtain
Centimeter/second	.3937	inches/second
Centimeter/second	1.969	feet/minute
Meter/second	3.281	feet/second
Meter/second	196.9	feet/minute
Meter/second	2.237	miles per hour
Inch/second	25.4	millimeters/second
Inch/second	2.54	centimeters/second
Foot/second	.3048	meters/second
Foot/minute	.0508	meters/second

BOSTON GEAR REGISTERED TRADEMARKS

BOSTON GEAR®

BOSTON®

BOSTonE®

BOST-BRONZ®

BEAR-N-BRONZ®

Application Classification for Various Loads

Type of Machine To Be Driven	Chart I For All Drives		
	Service Factor Loading		
	Not More Than 15 Mins. in 2 Hrs.	Not More Than 10 Hrs. per Day	More Than 10 Hrs. Per Day
AGITATORS			
Pure Liquid	0.80	1.00	1.25
Semi-Liquids, Variable Density	1.00	1.25	1.50
BLOWERS			
Centrifugal and Vane	0.80	1.00	1.25
Lobe	1.00	1.25	1.50
BREWING AND DISTILLING			
Bottling Machinery	0.80	1.00	1.25
Brew Kettles—Continuous Duty	—	—	1.25
Cookers – Continuous Duty	—	—	1.25
Mash Tubs – Continuous Duty	—	—	1.25
Scale Hopper – Frequent Starts	—	1.25	1.50
CAN FILLING MACHINES	—	1.00	—
CANE KNIVES	—	1.50	—
CAR DUMPERS	—	1.75	—
CAR PULLERS	—	1.25	—
CLARIFIERS	—	1.00	1.25
CLASSIFIERS	—	1.25	1.50
CLAY WORKING MACHINERY			
Brick Press & Briquette Machine	—	1.75	2.00
Extruders and Mixers	1.00	1.25	1.50
COMPRESSORS			
Centrifugal	—	1.00	1.25
Lobe – Reciprocating, Multi-Cycle	—	1.25	1.50
Reciprocating – Single Cycle	—	1.75	2.00
CONVEYORS— UNIFORMLY LOADED & FED			
Apron	—	1.00	1.25
Assembly-Belt – Bucket or Pan	—	1.00	1.25
Chain – Flight	—	1.00	1.25
Oven – Live Roll – Screw	—	1.25	1.50
CONVEYORS—HEAVY DUTY NOT UNIFORMLY FED			
Apron	—	1.25	1.50
Assembly-Belt – Bucket or Pan	—	1.25	1.50
Chain – Flight	—	1.25	1.50
Live Roll	—	—	—
Oven – Screw	—	1.25	1.50
Reciprocating – Shaker	—	1.75	2.00
CRANES AND HOISTS			
Main Hoists			
Bridge and Trolley Drive	*	1.00	1.25
CRUSHER			
Ore, Stone	—	1.75	2.00
Sugar	—	1.50	1.50

Type of Machine To Be Driven	Chart I For All Drives		
	Service Factor Loading		
	Not More Than 15 Mins. in 2 Hrs.	Not More Than 10 Hrs. per Day	More Than 10 Hrs. Per Day
ELEVATORS			
Bucket – Uniform Load	—	1.00	1.25
Bucket – Heavy Load	—	1.25	1.50
Centrifugal Discharge	—	1.25	1.50
Freight	—	1.25	1.50
Gravity Discharge	—	1.00	1.25
FANS			
Centrifugal – Light (Small Diam.)	—	1.00	1.25
Large Industrial	—	1.25	1.50
FEEDERS			
Apron – Belt – Screw	—	1.25	1.50
Disc	—	1.00	1.25
Reciprocating	—	1.75	2.00
FOOD INDUSTRY			
Beet Slicer	—	1.25	1.50
Cereal Cooker	—	1.00	1.25
Dough Mixer – Meat Grinder	—	1.25	1.50
GENERATORS (NOT WELDING)	—	1.00	1.25
HAMMER MILLS	—	1.75	2.00
HOISTS			
Heavy Duty	—	1.75	2.00
Medium Duty and Skip Type	—	1.25	1.50
LAUNDRY TUMBLERS	—	1.25	1.50
LINE SHAFTS			
Uniform Load	—	1.00	1.25
Heavy Load	—	1.25	1.50
MACHINE TOOLS			
Auxiliary Drive	—	1.00	1.25
Main Drive – Uniform Load	—	1.25	1.50
Main Drive – Heavy Duty	—	1.75	2.00
METAL MILLS			
Draw Bench Carriers & Main Drive	—	1.25	1.50
SLITTERS	—	1.25	1.50
TABLE CONVEYORS – NON REVERSING			
Group Drives	—	1.25	1.50
Individual Drives	—	1.75	2.00
Wiring Drawing, Flattening or Winding	—	1.25	1.50
MILLS ROTARY TYPE BALL AND ROD			
Spur Ring Gear and Direct Connected	—	—	2.00
Cement Kilns, Pebble	—	—	1.50
Dryers and Coolers	—	—	1.50
Plain and Wedge Bar	—	—	1.50
Tumbling Barrels	—	—	2.00

Application Classification for Various Loads (Continued)

Type of Machine To Be Driven	Chart I For All Drives		
	Service Factor Loading		
	Not More Than 15 Mins. in 2 Hrs.	Not More Than 10 Hrs. per Day	More Than 10 Hrs. Per Day
MIXERS			
Concrete – Continuous	—	1.25	1.50
Concrete – Intermittent	—	1.25	1.50
Constant Density	—	1.00	1.25
Semi-Liquid	—	1.25	1.50
OIL INDUSTRY			
Oil Well Pumping	—	—	*
Chillers, Paraffin Filter Press	—	1.25	1.50
Rotary Kilns	—	1.25	1.50
PAPER MILLS			
Agitator (Mixer)	—	1.25	1.50
Agitator – Pure Liquids	—	1.00	1.25
Barking Drums – Mechanical			
Barkers	—	1.75	2.00
Bleacher	—	1.00	1.25
Beater	—	1.25	1.50
Calender Heavy Duty	—	—	2.00
Calender Anti-Friction Brgs.	—	1.00	1.25
Cylinders	—	1.25	1.50
Chipper	—	—	2.00
Chip Feeder	—	1.25	1.50
Coating Rolls – Couch Rolls	—	1.00	1.25
Conveyors – Chips – Bark – Chemical	—	1.00	1.25
Conveyors – Log and Slab	—	—	2.00
Cutter	—	—	2.00
Cylinder Molds, Dryers (Anti-Friction Brg.)	—	—	1.25
Felt Stretcher	—	1.25	1.50
Screens – Chip and Rotary	—	1.25	1.50
Thickener (AC)	—	1.25	1.50
Washer (AC)	—	1.25	1.50
Winder – Surface Type	—	—	1.25
PLASTICS INDUSTRY			
Intensive Internal Mixers			
Batch Type	—	—	1.75
Continuous Type	—	—	2.00
Batch Drop Mill – 2 Rolls	—	—	1.25
Compounding Mills	—	—	1.25
Calenders	—	—	1.50
Extruder – Variable Speed	—	—	1.50
Extruder – Fixed Speed	—	—	1.75
PULLERS			
Barge Haul	—	—	2.00

Type of Machine To Be Driven	Chart I For All Drives		
	Service Factor Loading		
	Not More Than 15 Mins. in 2 Hrs.	Not More Than 10 Hrs. per Day	More Than 10 Hrs. Per Day
PUMPS			
Centrifugal	—	—	1.25
Proportioning	—	—	1.50
Reciprocating			
Single Acting, 3 or more Cycles	—	1.25	1.50
Double Acting, 2 or more Cycles	—	1.25	1.50
Rotary – Gear or Lube	—	1.00	1.25
RUBBER INDUSTRY			
Batch Mixers	—	—	1.75
Continuous Mixers	—	—	1.50
Calenders	—	—	1.50
Extruders – Continuous	—	—	1.50
Extruders – Intermittent	—	—	1.75
Tire Building Machines	—	—	—
Tire & Tube Press Openers	—	—	—
SEWAGE DISPOSAL EQUIPMENT			
Bar Screens	—	1.00	1.25
Chemical Feeders	—	1.00	1.25
Collectors	—	1.00	1.25
Dewatering Screws	—	1.25	1.50
Scum Breakers	—	1.25	1.50
Slow or Rapid Mixers	—	1.25	1.50
Thickeners	—	1.25	1.50
Vacuum Filters	—	1.25	1.50
SCREENS			
Air Washing	—	1.00	1.25
Rotary – Stone or Gravel	—	1.25	1.50
Traveling Water Intake	—	1.00	1.25
SKIP HOISTS	—	—	—
SLAB PUSHERS	—	1.25	1.50
STOKERS	—	—	1.25
TEXTILE INDUSTRY			
Batchers or Calenders	—	1.25	1.50
Cards	—	1.25	1.50
Card Machines	—	1.75	2.00
Dry Cans and Dryers	—	1.25	1.50
Dyeing Machines	—	1.25	1.50
Looms	—	1.25	1.50
Mangles, Nappers and Pads	—	1.25	1.50
Soapers, Tenner Frames	—	1.25	1.50
Spinners, Washers, Winders	—	1.25	1.50
TUMBLING BARRELS	1.50	1.75	2.00
WINDLASS	—	1.25	1.50

Index to Catalog Numbers

Catalog Number	Description	Page No.
0-B(L)G*	Chain Tensioners	302
0-H(U)G*	Chain Tensioners	304
06000	Gear Gauge Set	62
06724*	Thrust Washers	118
1 (A. AA)	Ladder Chains	262
2 (1/2)	Ladder Chains	262
2S(S)C12*	Clamp Collars	
2S(S)C25*	Clamp Collars	117
3A-1/2*	Adj. Shaft Supports	231
3A-1/2 B&C*	Replacement Bearings	213
3F(T)-1/2*	Flange Cartridges	225
3H(L)-1/2*	Pillow Blocks	218
3M035060*	Timing Belts	124
5M064150*	Timing Belts	130
5R21-16S*	Coupling Sleeve Stock	
8P40AF(D,GS)-1/4*	Roll End Bearings	166
12EMAF(D,GS)*	Roll End Bearings	162
15BP(SS)7*	Roller Chain Sprockets	266
25A(B)9*	Roller Chain Sprockets	275
25B9SS*	Roller Chain Sprockets	276
35A(B)8*	Roller Chain Sprockets	277
35B9SS*	Roller Chain Sprockets	279
35B12T1-8*	Idler Sprockets	301
40A(B)9*	Roller Chain Sprockets	282
40B10SS*	Roller Chain Sprockets	286
40HP*	Roller Chain	260
41A(B)22*	Roller Chain Sprockets	270
50A(B)8*	Roller Chain Sprockets	287
5(6)0-BG*	Chain Tensioners	303
60A(B)8*	Roller Chain Sprockets	291
60H*	Roller Chain	253
80A(B)8*	Roller Chain Sprockets	295
601*	Ball Bearings	194
622AF(D,GS)-1/8*	Roll End Bearings	162
1602DC(DS)*	Ball Bearings	185
3002DC(DS)*	Ball Bearings	190
7508DL(DLG)*	Ball Bearings	187
7610DL(DLG)*	Ball Bearings	188
11722*	Shaft Couplings & Inserts	102
18510*	Steel Bushings	119
18800*	Steel Washers*	118
31300(4)	Bear-N-Bronz Banks	154
A		
A(AA1)*	Roller Chain Attachments	259
AF1012-6*	Bostone Bearings	161
AO1*	Ball Bearings	193
B		
B24-1*	Bost-Bronz Bearings	138
B503*	Block Chains	261
BBB-1	Bost-Bronz Bank	154
BF7-3/8-3/8*	Shaft Couplings	102

Catalog Number	Description	Page No.
BG11-1-3-3*	Shaft Couplings	103
BG47-2-2*	Shaft Couplings	103
BL423*	Leaf Chains	261
C		
C1-6*	Ladder Chain Sprockets	300
C2040HP*	Roller Chain	252
CA7*	Ladder Chain Sprockets	260
CA(S)C18*	Clamp Collars	116
CB1(A)6*	Ladder Chain Sprockets	299
CB3-10*	Lader Chain Sprockets	300
CB816*	Bost-Bronz Cored Bars	144
CBT60*	Chain Breakers	264
CD1142*	Worm Gears	89
CFHD(L)-3*	Rod Ends	200
CG1042*	Worm Gears	89
CMHD(L)-3*	Rod Ends	200
CQ1342*	Worm Gears	89
CR4*	Shaft Couplings	105
CS(S)C10-32*	Clamp Collars	115
CSC12*	Clamp Collars	116
D		
D1	Roller Chain Attachments	259
D35B16*	Roller Chain Sprockets	279
D40B13*	Roller Chain Sprockets	286
D50B15*	Roller Chain Sprockets	290
D60B15*	Roller Chain Sprockets	294
D(B)620A*	Worm Gears	93
D(B)860A*	Worm Gears	92
D1080A	Worm Gear	91
D1118*	Worm Gears	86
D1126*	Worm Gears	87
D1134*	Worm Gears	88
D1142*	Worm Gears	89
D1260A*	Worm Gears	90
D(B)1400*	Worm Gears	90
D1407K	Worm	90
D(B)1410*	Worm Gears	91
D1418K*	Worms	91
D1418-10	Bostone Bearing	161
D(B)1420A*	Worm Gears	92
D(B)1427K*	Worms	92
D(B)1430A*	Worm Gears	93
D1438(K)*	Worms	93
D(B)1600*	Worm Gears	90
D(B)1610*	Worm Gears	91
D(B)1620A*	Worm Gears	92
D(B)1630A*	Worm Gears	93
DH1407*	Worms	90
DH1418*	Worms	91
DH1438*	Worms	93
DSH-1	Worm	86

*Initial number, larger numbers arranged according to size.

Index to Catalog Numbers

Catalog Number	Description	Page No.	Catalog Number	Description	Page No.
DTH-1	Worm	87	GDUH	Worm	88
DUH	Worm	88	GDVH-1	Worm	89
DVH-1	Worm	89	GF20*	Change Gears	31
DH1427*	Worms	92	GFB10A	Compound Bushing	31
F			GH20*	Change Gears	32
F7612B*	Ball Bearing Insert	169	GH1056	Worm	90
FA5-3/16-3/16*	Shaft Coupling	105	GH1066	Worm	91
FB25-2*	Bost-Bronz Flanged Brgs.	141	GH1076	Worm	92
FC12-3/8*	Shaft Coupling	100	GH1086	Worm	93
FC12-SOLID*	Shaft Coupling	101	GHB8A	Compound Bushing	32
FCP21-1/8*	Shaft Coupling	106	GLSH-1	Worm	86
FH547*	Roll End Adaptors	169	GLTH-1	Worm	87
FP35-2*	Bostone Flanged Brgs.	156	GLUH	Worm	88
G			GLVH-1	Worm	89
G(S)24*	Pinion Wire	34	GP579-1*	Racks	35
G96*	Spur Gears	18	GP1018(-1/8)*	Worm Gears	86
G182*	Spur Gears	19	GP1026(-3/16)*	Worm Gears	87
G226*	Spur Gears	21	GP1034(-3/16)*	Worm Gears	88
G460Y*	Miter Gears	70	GP1616Y*	Miter Gears	71
G478Y-G*	Bevel Gears	74	GP2424Y*	Miter Gears	70
G632*	Internal Gears	36	GQSH-1	Worm	86
G(B)850*	Worm Gears	92	GQTH-1	Worm	87
G1018*	Worm Gears	86	GQUH	Worm	88
G1026*	Worm Gears	87	GQVH-1	Worm	89
G1034*	Worm Gears	88	GS48-7*	Bostone Bearings	161
G1042*	Worm Gears	89	GSS460Y*	Miter Gears	70
G(B)1050A*	Worm Gears	90	GSS479Y*	Bevel Gears	74
G(B)1060A*	Worm Gears	91	H		
G1066K	Worm	91	H608L(R)*	Helical Gears	65
G(B)1070*	Worm Gears	92	H917	Block Chain Sprockets	290
G1076K	Worm	92	H1008L(R)*	Helical Gears	64
G(B)1077*	Worm Gears	93	H1056*	Worms	90
G1086K	Worm	93	H1066*	Worms	91
G(B)1100*	Worm Gears	94	H1076*	Worms	92
G1106KL(R)	Worm	94	H1086*	Worms	93
G1110*	Worm Gears	95	H1106	Worm	94
G1116K	Worm	95	H1116	Worm	95
G1202*	Grooved Pulley	120	H1427L(R)	Worms	92
G(B)1260	Worm Gear	90	H2412*	Spur Gears	20
G1616GS-1/2	Guide Roll Bearing	170	H3216*	Spur Gears	19
G(B)8100*	Worm Gears	92	HB612L(R)*	Helical Gears	65
GA20*	Change Gears	28	HDSH-1	Worm	86
GAB20A	Compound Bushing	28	HDTH-1	Worm	87
GB20*	Change Gears	29	HDUH	Worm	88
GBB16A*	Compound Bushing	29	HDVH-1	Worm	89
GD20A*	Change Gears	30	HF(L)-3*	Rod Ends	201
GDB12A	Compound Bushing	30	HF(L)-3C*	Rod Ends	199
GDSH-1	Worm	86	HF(L)-4CG*	Rod Ends	199
GDTH-1	Worm	87	HF(L)-4G*	Rod Ends	201
G1202*	Pulleys	120	HF(L)E-3*	Rod Ends	202
			HFX(L)-4G*	Rod Ends	203

*Initial number, larger numbers arranged according to size.

Index to Catalog Numbers

Catalog Number	Description	Page No.
HL146Y-G*	Bevel Gears	75
HL147Y-G*	Bevel Gears	74
HL153Y-G*	Bevel Gears	76
HL156Y-G	Bevel Gears	77
HL1056*	Worms	90
HL1066*	Worms	91
HL1076*	Worms	92
HL1086*	Worms	93
HL1106	Worm	94
HL1116	Worm	95
HLK101Y*	Miter Gears	71
HLK105Y*	Miter Gears	72
HLSH-1	Worm	86
HLSK101Y*	Spiral Miter Gears	73
HLTH-1	Worm	87
HLUH	Worm	88
HLVH-1	Worm	89
HM(L)-3*	Rod Ends	201
HM(L)-3C*	Rod Ends	199
HM(L)-4CG*	Rod Ends	199
HM(L)-4G*	Rod Ends	201
HM(L)E-3*	Rod Ends	202
HMX(L)-4G*	Rod Ends	203
HP1106	Worm	94
HQSH-1	Worm	86
HQTH-1	Worm	87
HQUH	Worm	88
HQVH-1	Worm	89
HS608L(R)*	Helical Gears	65
J		
J37(A)*	Universal Joints	108
J37(B)*	Universal Joints	108
J37(B)-01*	Universal Joint Parts	108
JP(D)25-1/8*	Universal Joints	112
JPE37-1/8*	Universal Joints	113
JS37(B)*	Universal Joints	108
K		
K(KK)1(2)	Chain Attachments	259
KF(L)-3	Rod Ends	198
L		
L93Y*	Miter Gears	70
L99Y*	Miter Gears	71
L105Y*	Miter Gears	72
L146Y-G*	Bevel Gears	75
L147Y-G*	Bevel Gears	74
L153Y-G*	Bevel Gears	76
L156Y-G*	Bevel Gears	77
L204-4*	Racks	47
L501-2*	Racks	35
L1056*	Worms	90

Catalog Number	Description	Page No.
L1066*	Worms	91
L1076	Worm	92
L1086*	Worms	93
L1106	Worm	94
L1116	Worm	95
L1427	Worm	92
L1438	Worm	93
LHA(B,SS)2*	Spherical Bearings	204
LHSSE(VV)2*	Spherical Bearings	205
LS3*	Spherical Bearings	206
LSA101Y*	Spiral Miter Gears	73
LSH(P)	Worms	86
LTHB(P)	Worms	87
LUHB(P)	Worms	88
LVHB-1	Worm	89
M		
M1(35)	Chain Attachments	259
M35(2)	Chain Attachments	259
M35-4*	Bear-N-Bronz Bearings	146
MB-1-7/16*	Pillow Blocks	222
MBF-1-7/16*	Flanged Cartridges	229
MBP-1-7/16*	Piloted Flanges	230
MCB816*	Bear-N-Bronz Cored Bars	151
MM1(35)	Chain Attachments	259
MM1(35)(-2)	Chain Attachments	259
MS8*	Bear-N-Bronz Solid Bars	153
N		
N6906(B)*	Ball Bearings	189
NA11B(-5/16)*	Spur Gears	20
NAR5*	Steel Stem Pinions	33
NB11B(-3/8)*	Spur Gears	21
NBG15-1/2*	Replacement Bearings	214
ND11B(-1/2)*	Spur Gears	22
NF11B(-5/8)*	Spur Gears	23
NF35-2-1/2	Bostone Flanged Bearing	172
NH11B(-3/4)*	Spur Gears	24
NJ11B(-1)*	Spur Gears	25
NK11B*	Spur Gears	26
NL11B*	Spur Gears	27
NO11B*	Spur Gears	27
NR2000*	Ball Bearing Sheaves	195
NR2105*	Ball Bearing Sheaves	196
NR2201*	Ball Bearing Wheels	197
NS35-2-1/2*	Bostone Bearings	172
NT312*	Bostone Bearings	173
NX3008-(LC,M)*	Replacement Bearings	213
O		
OA424Y*	Miter Gears	72

*Initial number, larger numbers arranged according to size.

Index to Catalog Numbers

Catalog Number	Description	Page No.
P		
P24-2*	Boston F-1 Bearings	156
P1250-2*	Nylon Cable Pulleys	173
PA528Y-G(P)*	Bevel Gears	77
PA3212Y-G(P)*	Bevel Gears	76
PA3316Y-G(P)*	Bevel Gears	75
PA3010(D,N)F060*	Timing Belt Pulleys	125
PA3010(D,N)F090*	Timing Belt Pulleys	126
PA5012(D,N)F090*	Timing Belt Pulleys	131
PA5012(D,N)F150*	Timing Belt Pulleys	132
PB5602*	Bost-Bronz Plates	143
PL3010(D,S)F090*	Timing Belt Pulleys	127
PL5011(D,S)F090*	Timing Belt Pulleys	133
PLB3010(D,S)F090*	Timing Belt Pulleys	128
PLB3032(D,S)F090*	Timing Belt Pulleys	129
PLB5011(D,S)F090*	Timing Belt Pulleys	134
PPB4-1/4*	Pillow Blocks	215
PS-1/2*	Pillow Blocks	216
PS(2,3)-1/2*	Flanged Cartridges	223
Q		
Q620A*	Worm Gears	93
Q860A	Worm Gears	92
Q1080A	Worm Gears	91
Q1260A	Worm Gears	90
Q1318*	Worm Gears	86
Q1326*	Worm Gears	87
Q1334*	Worm Gears	88
Q1342*	Worm Gears	89
QB(H)16*	Spur Gears	22
QB616*	Worm Gears	93
QB808*	Worm Gears	92
QB1016*	Worm Gears	91
QB1212*	Worm Gears	90
QD(H)15*	Spur Gears	23
QFH15*	Spur Gears	23
QHH16*	Spur Gears	24
QSH-1	Worm	86
QTH-1	Worm	87
QUH	Worm	88
QVH-1	Worm	89
R		
R700(D,GS)*	Bostone Bearing	170
RFP46-4	Rulon Flange Bearings	159
RP46-2	Rulon Sleeve Bearings	159
RSP8	Rulon Solid Bar	159
S		
S2412*	Spur Gears	20
S3216*	Spur Gears	19
SA01*	Ball Bearings	193
SB4*	Bost-Bronz Solid Bars	144
SC4	Bostone Shaft Clip	171
S(S)C12*	Setscrew Collars	114
SCC1/4-1/4*	Shaft Couplings	104
SF(T)-1/2*	Flanged Cartridges	227
SH(L)-1/2*	Pillow Blocks	220
SH(S)82-G(P)*	Spiral Bevel Gears	78

Catalog Number	Description	Page No.
SP4*	Bostone F-1 Solid Bars	157
SRP-1/4*	Pillow Blocks	215
SS4	Bostone Stub Shaft	171
SS82-G(P)*	Spiral Bevel Gears	78
SSFC12-3/8*	Stainless Steel Shaft Coupling	100
SSHP4-3/4*	Stainless Steel Pillow Blocks	234
SSUF4-3/4*	Stainless Steel 4 Bolt Flange	236
SSUFB4-3/4*	Stainless Steel 3 Bolt Flange Bracket	237
SSUFL4-3/4*	Stainless Steel 2 Bolt Flange	235
SSUP4-3/4*	Stainless Steel Pillow Blocks	233
SSUT4-3/4*	Stainless Steel Take Up Units	238
SP4*	Bostone F-1 Solid Bars	157
SRP-1/4*	Pillow Blocks	215
SS4	Bostone Stub Shaft	171
SS82-G(P)*	Spiral Bevel Gears	78
T		
TB47*	Bost-Bronz Thrust Brg.	143
TH35-60*	Chain Pullers	256
TP410*	Bostone Thrust Bearings	157
TU816-6*	Take-Up Frames	232
U		
UB37*	Universal Joint Boot Kits	108
UJ(L,S)10(S,H)*	Universal Joint Yokes	111
UJN(L,S)10-10*	Universal Joints	110
UJ(L,S)(C,D)	Universal Joint Center Kits	111
W		
WA(1,2)	Chain Attachments	251
WK(1,2)	Chain Attachments	251
WM(1,2,35,35-2)	Chain Attachments	251
X		
X5R21-16	Shaft Coupling Part	106
XCBT60-5*	Chain Breaker Tips	256
XFC(A,BB,R)12*	Shaft Coupling Part	101
XFCP21-1/8*	Shaft Coupling Part	106
XL-1/2*	Pillow Blocks	217
XL(2,3)-1/2*	Flanged Cartridges	224
Y		
Y2412*	Spur Gears	42
Y3212*	Spur Gears	40
Y4812*	Spur Gears	39
Y6416*	Spur Gears	37
YA12(-5/16)*	Spur Gears	42
YB12(-3/8)*	Spur Gears	43
YD12(-1/2)*	Spur Gears	43
YF12(-5/8)*	Spur Gears	44
YH12(-3/4)*	Spur Gears	45
YI2436*	Internal Gears	48
YJ12(-1)*	Spur Gears	45
YK12*	Spur Gears	46
YP2412*	Spur Gears	41
YP3212*	Spur Gears	39
YP4818*	Spur Gears	37
YP4844*	Spur Gears	38
YPB2412*	Spur Gears	41
YPB3212*	Spur Gears	40
YPB4818*	Spur Gears	38

*Initial number, larger numbers arranged according to size.

Boston Gear Online Resources

VISIT US ON THE WEB AT
WWW.BOSTONGEAR.COM

Everything Boston Gear

From the Boston Gear homepage you can explore all of our resources and visit our key market portals to find solutions for your specific needs.

WWW.BOSTONGEAR.COM

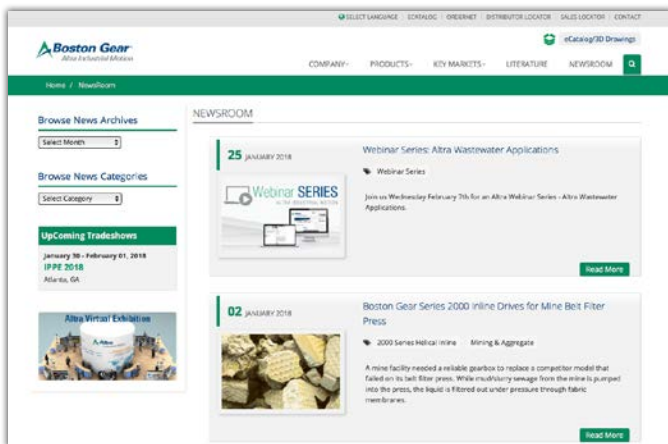
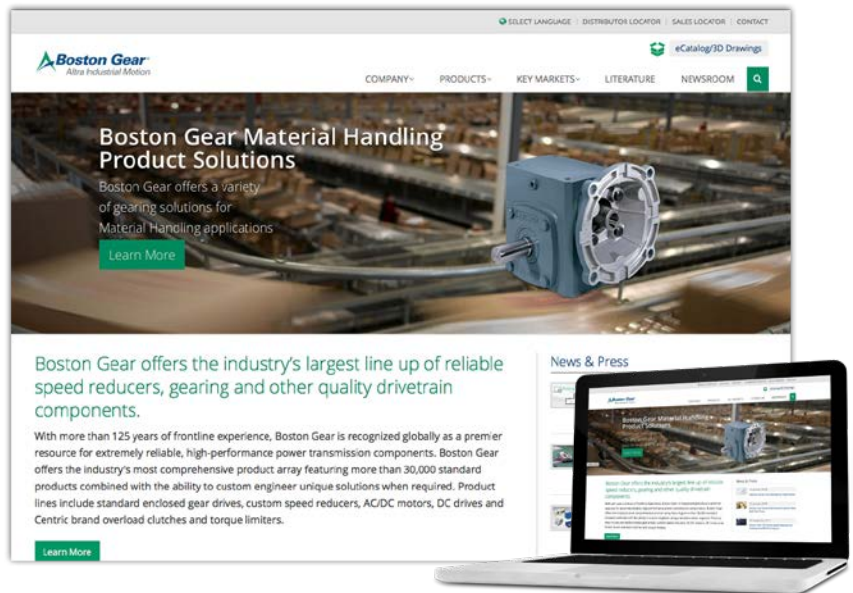

Get Connected

The Boston Gear Newsroom makes it quick and easy for you to get the news you need when you need it. From new literature releases to trade show schedules, the news is at your fingertips 24 hours a day.

WWW.BOSTONGEAR.COM/NEWSROOM

Boston Gear eCatalog

The eCatalog offers product selections and comparisons to meet your specific needs. Download 2D and 3D CAD formats and dimensional line drawings.

Submit an online RFQ to the local distributor of your choice.

WWW.BOSTONGEAR.COM/ECATALOG

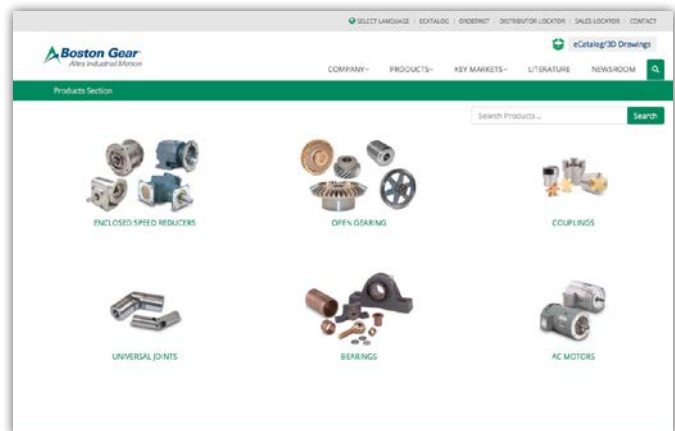

Boston Gear Facilities

North America

USA

701 Carrier Drive
Charlotte, NC 28216 - USA
704-588-5610

*Enclosed and Open Gearing,
Electrical and Mechanical
P.T. Components*

Customer Service

1-800-825-6544

Application Support

1-800-816-5608

The Brands of Altra Motion

Couplings

Ameridrives
www.ameridrives.com

Bibby Turboflex
www.bibbyturboflex.com

Guardian Couplings
www.guardiancouplings.com

Huco
www.huco.com

Lamiflex Couplings
www.lamiflexcouplings.com

Stromag
www.stromag.com

TB Wood's
www.tbwoods.com

Linear Systems

Thomson
www.thomsonlinear.com

Geared Cam Limit Switches

Stromag
www.stromag.com

Engineered Bearing Assemblies

Kilian
www.kilianbearings.com

Electric Clutches & Brakes

Matrix
www.matrix-international.com

Stromag
www.stromag.com

Warner Electric
www.warnerelectric.com

Belted Drives

TB Wood's
www.tbwoods.com

Heavy Duty Clutches & Brakes

Twiflex
www.twiflex.com

Stromag
www.stromag.com

Svendborg Brakes
www.svendborg-brakes.com

Wichita Clutch
www.wichitaclutch.com

Gearing & Specialty Components

Bauer Gear Motor
www.bauergears.com

Boston Gear
www.bostongear.com

Delevan
www.delevan.com

Delroyd Worm Gear
www.delroyd.com

Nuttall Gear
www.nuttallgear.com

Engine Braking Systems

Jacobs Vehicle Systems
www.jacobsvehiclesystems.com

Precision Motors & Automation

Kollmorgen
www.kollmorgen.com

Miniature Motors

Portescap
www.portescap.com

Overrunning Clutches

Formsprag Clutch
www.formsprag.com

Marland Clutch
www.marland.com

Stieber
www.stieberclutch.com

Neither the accuracy nor completeness of the information contained in this publication is guaranteed by the company and may be subject to change in its sole discretion. The operating and performance characteristics of these products may vary depending on the application, installation, operating conditions and environmental factors. The company's terms and conditions of sale can be viewed at <http://www.altramotion.com/terms-and-conditions/sales-terms-and-conditions>. These terms and conditions apply to any person who may buy, acquire or use a product referred to herein, including any person who buys from a licensed distributor of these branded products.

©2020 by Boston Gear LLC. All rights reserved. All trademarks in this publication are the sole and exclusive property of Boston Gear LLC or one of its affiliated companies.