



COMPACT TRANS-TECH® PRESSURE FEED / SIPHON FEED SPRAYGUN



IMPORTANT! DO NOT DESTROY

It is the Customer's responsibility to have all operators and service personnel read and understand this manual.
Contact your local DeVilbiss representative for additional copies of this manual.

READ ALL INSTRUCTIONS BEFORE OPERATING THIS DEVILBISS PRODUCT.

Product Description/Object of Declaration: Compact



This Product is designed for use with: Solvent and Water based Materials

Suitable for use in hazardous area: Zone 1 / Zone 2

Protection Level: II 2 G X











Notified body details and role: TRAC Global Ltd (0891)
Lodging of Technical file

This Declaration of Conformity /incorporation is issued under the sole responsibility of the manufacturer: Carlisle Fluid Technologies UK Ltd,
Ringwood Road,
Bournemouth, BH11 9LH. UK

EU Declaration of Conformity		 
The object of the declaration described above is in conformity with the relevant Union harmonisation legislation:		
Machinery Directive 2006/42/EC ATEX Directive 2014/34/EU by complying with the following statutory documents and harmonized standards: EN ISO 12100:2010 Safety of Machinery - General Principles for Design BS EN 1953:2013 Atomising and spraying equipment for coating materials - Safety requirements EN 1127-1:2011 Explosive atmospheres - Explosion prevention - Basic concepts EN 13463-1:2009 Non electrical equipment for use in potentially explosive atmospheres - Basic methods and requirements		
Providing all conditions of safe use / installation stated within the product manuals have been complied with and also installed in accordance with any applicable local codes of practice.		
Signed for and on behalf of Carlisle Fluid Technologies UK Ltd:		<p style="text-align: right;">Director of Sales (EMEA)</p> <p style="text-align: center;">Dave Smith 11-Jul-16</p> <p style="text-align: right;">Bournemouth, BH11 9LH, UK</p>



SAFETY WARNINGS

   	<p>FIRE AND EXPLOSION</p> <p>Solvents and coating materials can be highly flammable or combustible when sprayed. ALWAYS refer to the coating material suppliers instructions and COSHH sheets before using this equipment.</p> <p>Users must comply with all local and national codes of practice and insurance company requirements governing ventilation, fire precautions, operation and house-keeping of working areas.</p> <p>This equipment, as supplied, is <u>NOT</u> suitable for use with <u>Halogenated Hydrocarbons</u>.</p> <p>Static Electricity can be generated by fluid and/or air passing through hoses, by the spraying process and by cleaning non- conductive parts with cloths. To prevent ignition sources from static discharges, earth continuity must be maintained to the spraygun and other metallic equipment used.</p>
    	<p>PERSONAL PROTECTIVE EQUIPMENT</p> <p>Toxic vapors – When sprayed, certain materials may be poisonous, create irritation or be otherwise harmful to health. Always read all labels and safety data sheets for the material before spraying and follow any recommendations. If In Doubt, Contact Your Material Supplier.</p> <p>The use of respiratory protective equipment is recommended at all times. The type of equipment must be compatible with the material being sprayed.</p> <p>Always wear eye protection when spraying or cleaning the spraygun</p> <p>Gloves must be worn when spraying or cleaning the equipment.</p> <p>Training – Personnel should be given adequate training in the safe use of spraying equipment.</p>
	<p>MISUSE</p> <p>Never aim a spraygun at any part of the body.</p> <p>Never exceed the max. recommended safe working pressure for the equipment.</p> <p>The fitting of non-recommended or non-original spares may create hazards.</p> <p>Before cleaning or maintenance, all pressure must be isolated and relieved from the equipment.</p> <p>The product should be cleaned using a gun washing machine. However, this equipment should not be left inside gun washing machines for prolonged periods of time.</p>
	<p>NOISE LEVELS</p> <p>The A-weighted sound level of sprayguns may exceed 85 dB (A) depending on the set-up being used. Details of actual noise levels are available on request. It is recommended that ear protection is worn at all times when spraying.</p>
	<p>OPERATING</p> <p>Spray Equipment using high pressures may be subject to recoil forces. Under certain circumstances, such forces could result in repetitive strain injury to the operator.</p>

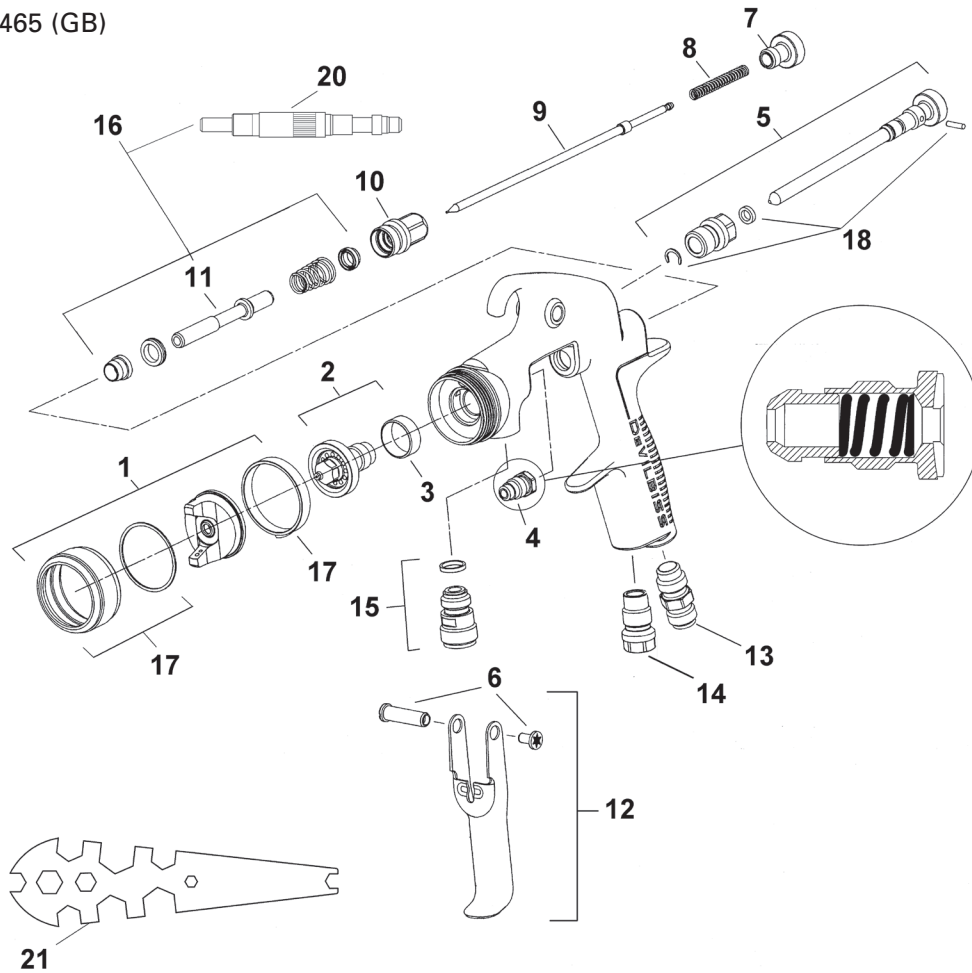

MODEL PART NUMBER

Example: **COM-PS510G-14-00**

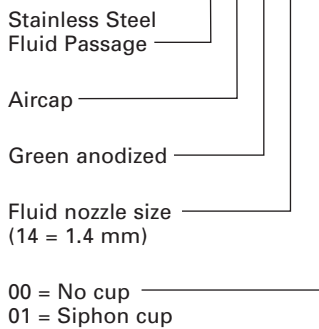

PARTS LIST

Ref. No.	Description	Part Number	Qty.	Options
1	Air Cap/Retaining ring COM-510, COM-513 or COM-522	SP-100-***-K	1	510, 513, 522 e.g *** = 510
2	Nozzle	SP-200S-**-K	1	10, 12, 14, 18, 22 e.g ** =14 =1.4 mm
+3	Separator (Pack of 5)	SP-623-K5	1	
+4	Packing (Pack of 2)	GTI-445-K2	1	
5	Spreader Valve	SP-401-K	1	
6	Stud and Screw		1	
7	Needle Adjusting Screw	SP-614-K	1	
+8	Spring (Pack of 5)	SP-622-K5	1	
9	Needle	SP-300S-**-K	1	10, 12, 14, 18, 22 e.g ** =14 =1.4 mm
10	Airvalve housing & seal	SP-612-K	1	
•11	Spindle		1	
12	Trigger, Stud and Screw	SP-617-CR-K	1	
13	Connector	SP-611-K	1	
14	Plug	JGA-132	1	
15	Fluid Inlet Connector and seal	SP-636-K	1	
17	Retaining Ring and Seals	SPK-102-K	1	
+18	Clip, Seal and Pin Kit (Pack of 5)	GTI-428-K5	1	
•20	Air Valve Assembly Tool		1	
21	Spanner	SPN-5	1	
	Spraygun Service Kit includes 1 each of parts marked +	SPK-402-K	1	
16	Air Valve Service Kit includes 1 each of parts marked •	SPK-101-K	1	

*T-20 six point star wrench required.

SPECIFICATION

Air supply connection:
Universal 1/4" BSP and NPS

Fluid supply connection:
Universal 3/8" BSP and NPS

Maximum static Air inlet pressure:
 $P_1 = 12$ bar (175 psi)

Maximum static Fluid inlet pressure:
 $P_2 = 15$ bar (218 psi)

Nominal gun Air inlet pressure with gun triggered: 2 bar (29 psi)
510, 513 & 522 Trans-Tech Air Cap

Maximum Service temperature: 40°C

Gun Weight: 412 g

MATERIALS OF CONSTRUCTION

Gun body: Anodized Aluminum

Nozzle: Stainless Steel

Needle: Stainless Steel

Fluid Inlet / Fluid Passages:
Stainless Steel / PTFE

Trigger: Nickel Plated Steel

AIR CAP SPECIFICATIONS

SP-100-510-K (Pressure/Siphon)
10.0 CFM @ 29 psi inlet
Fan Pattern Max: 10.6"

SP-100-513-K (Pressure/Siphon)
14.1 CFM @ 29 psi inlet
Fan Pattern Max: 13.8"

SP-100-522-K (Pressure only)
14.5 CFM @ 29 psi inlet
Fan Pattern Max: 13.8"

INSTALLATION

Important: To ensure that this equipment reaches you in first class condition, protective coatings have been used. Flush the equipment through with a suitable solvent before use.

1. Attach air hose to connector (13). Recommended hose size 8 mm bore. The hose must be conductive and electrical bond from the spraygun to earth should be checked with an ohmeter. A resistance of less than 10^6 Ohms is recommended.
2. Attach fluid supply hose to Fluid Inlet (15).

OPERATION

1. Mix coating material to manufacturers instructions
2. Turn needle adjusting screw (7) clockwise to prevent movement.
3. Turn spreader valve (5) counter-clockwise to fully open.
4. Adjust inlet air pressure (For recommended figures see Specifications) at the gun inlet with the gun triggered. (pressure gauge attachment shown under Accessories is recommended for this).
5. Turn needle adjusting screw counter clockwise until first thread shows.
6. Test spray. If the finish is too dry reduce airflow by reducing air inlet pressure or by the Airflow Valve (14). Screw the Adjusting Knob (14) in to reduce pressure.
7. If finish is too wet reduce fluid flow by turning needle screw (7) clockwise or reducing the fluid pressure. If atomization is too coarse, increase inlet air pressure. If too fine reduce inlet pressure.
8. The pattern size can be reduced by turning adjusting valve (5) clockwise.
9. Hold gun perpendicular to surface being sprayed. Arcing or tilting may result in uneven coating.

10. The recommended spray distance is 150-200 mm (6"-8").
11. Spray edges first. Overlap each stroke a minimum of 50%. Move gun at a constant speed.
12. Always turn off air and fluid supply and relieve pressure when gun is not in use.

PREVENTATIVE MAINTENANCE

1. Turn off air and coating supply and relieve pressure in the supply lines, or if using QD system, disconnect from airline and fluid line.
2. Remove air cap (1) and clean. If any of the holes in the cap are blocked with coating material use a toothpick to clean. Never use metal wire which could damage the cap and produce distorted spray patterns
3. Ensure the tip of the nozzle (2) is clean and free from damage. Build up of dried paint can distort the spray pattern.
4. Lubrication – stud/screw (6), needle (9) and air valve (11) should be oiled each day.

REPLACEMENT OF PARTS

Nozzle (2) and Needle (9) – Remove parts in the following order: 7, 8, 9, 1 and 2. Replace any worn or damaged parts and re-assemble in reverse order. Recommended tightening torque for nozzle (2) 9.5-12 Nm (80-100 lbf in).

Packing – Remove parts 7, 8, 9. Unscrew cartridge (4). Fit new cartridge finger tight. Re-assemble parts 9, 8, and 7 and tighten cartridge (4) with spanner sufficient to seal but to allow free movement of needle. Lubricate with gun oil.

Air Valve Seal Kit (16) – (Refer to photos 1 to 28 and fig 2)

Spreader valve (5) – **Caution:** always ensure that the valve is in the fully open position by turning screw fully counter-clockwise before fitting to body.

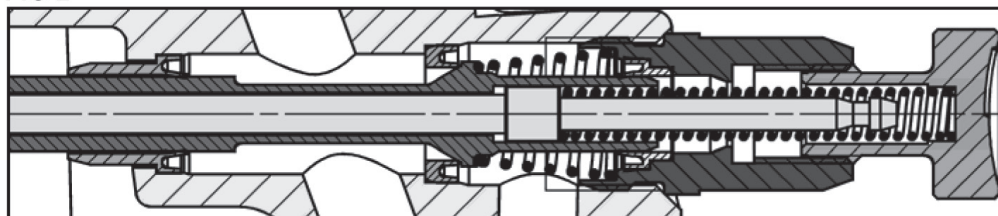
FIG 2



1. Remove Adjusting Knob (7), Spring (8), and Needle (9).

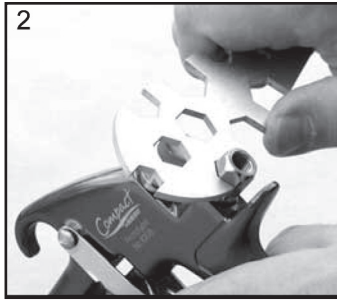

2. Loosen Housing (10).

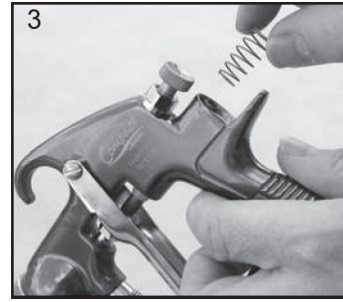

3. Remove Housing (10) and Air Valve Spring.



4. Remove Valve (11).



5. Using Service Tool SPN-7, engage groove behind the Valve Seat.



6. Remove Valve Seat.

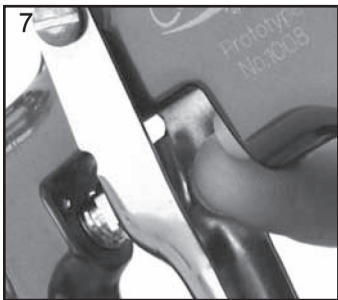

7. Push out the Front Air Valve Seal with a finger.

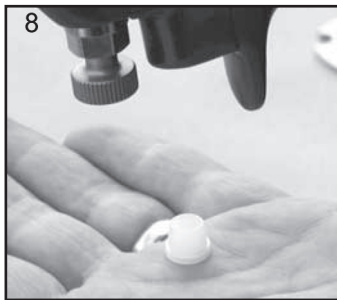

8. Turn the Gun upside down and let the Seal fall out.

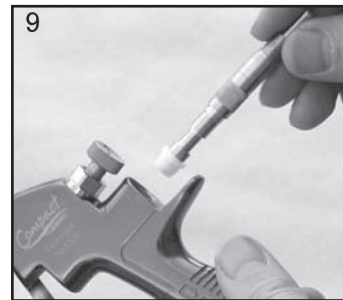

9. Fit New Front Seal to Service Tool.



10. Fit new Seal to gunbody and press firmly to ensure Seal is engaged.

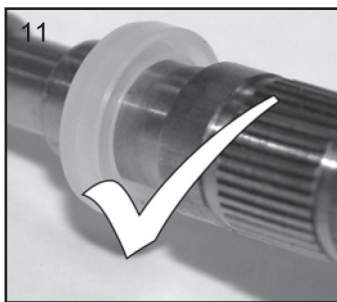

11. Fit New Valve Seat to Service Tool. Groove must face outwards.

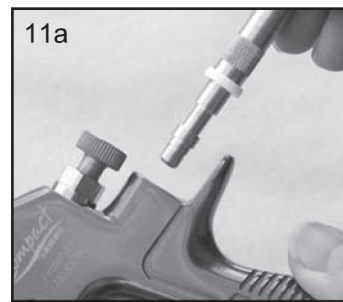

11a

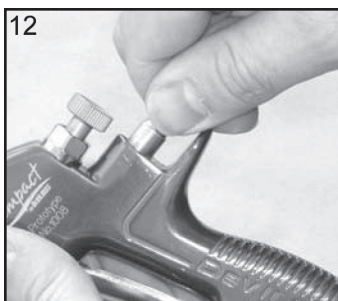

12. Fit Valve Seat to Gunbody.



13. Remove Rear Air Valve Seal from housing (10) with a hooked instrument.

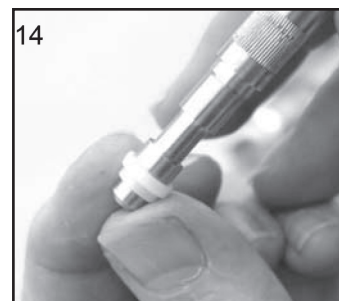

14. Fit new Seal to Service Tool.



15. Fit Seal to Housing (10).



16. Replace Valve (11).



17. Replace Valve Spring and screw in Housing (10).



18. Tighten Housing.



19. Fit Needle (9).

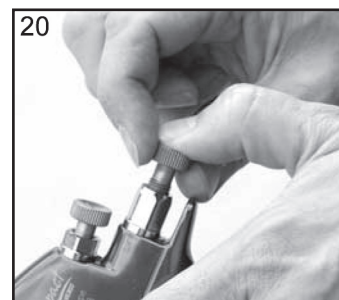





20. Fit Spring (8) and Knob (7).



21. Adjust Needle Packing (4) with Spanner sufficient to seal but to allow free movement of needle. Lubricate with gun oil.

TROUBLESHOOTING













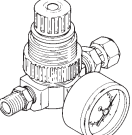

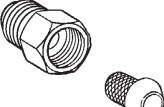
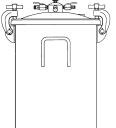

CONDITION	CAUSE	CORRECTION
Heavy top or bottom pattern 	Horn holes plugged. Obstruction on top or bottom of fluid tip. Cap and/or tip seat dirty.	Clean. Ream with non-metallic point. Clean. Clean.
Heavy right or left side pattern 	Left or right side horn holes plugged. Dirt on left or right side of fluid tip. Remedies for the top-heavy, bottom-heavy, right-heavy and left-heavy patterns: 1) Determine if the obstruction is on the air cap or the fluid tip. Do this by making a test spray pattern. Then, rotate the cap one-half turn and spray another pattern. If the defect is inverted, obstruction is on the air cap. Clean the air cap as previously instructed. 2) If the defect is not inverted, it is on the fluid tip. Check for a fine burr on the edge of the fluid tip. Remove with #600 wet or dry sand paper. 3) Check for dried paint just inside the opening. Remove paint by washing with solvent.	Clean. Ream with non-metallic point. Clean.
Heavy center pattern 	Fluid pressure too high for atomization air (pressure feed). Material flow exceeds air cap's capacity. Spreader adjustment valve set too low. Atomizing pressure too low. Material too thick.	Balance air and fluid pressure. Increase spray pattern width with spreader adjustment valve. Thin or lower fluid flow. Adjust. Increase pressure. Thin to proper consistency.
Split spray pattern 	Atomization air pressure too high. Fluid pressure too low (pressure feed only). Spreader adjusting valve set too high.	Reduce at transformer or gun. Increase fluid pressure (increases gun handling speed). Adjust.
Jerky or fluttering spray 	*Loose or damaged fluid tip/seat. Material level too low. Container tipped too far. Obstruction in fluid passage. Loose or broken fluid tube or fluid inlet nipple. Dry or loose fluid needle packing nut.	Tighten or replace. Refill. Hold more upright. Backflush with solvent. Tighten or replace. Lubricate or tighten.
Unable to get round spray	Spreader adjustment screw not seating properly. Air cap retaining ring loose.	Clean or replace. Tighten.
Will not spray	No air pressure at gun. Internal mix or pressure feed air cap and tip used with suction feed. Fluid pressure too low with internal mix cap and pressure tank. Fluid needle adjusting screw not open enough. Fluid too heavy for suction feed.	Check air supply and air lines. Change to proper suction feed air cap and tip. Increase fluid pressure at tank. Open fluid needle adjusting screw. Thin material or change to pressure feed.
Excessive overspray	Too much atomization air pressure Gun too far from work surface. Improper stroking (arcing, gun motion too fast).	Reduce pressure. Adjust to proper distance. Move at moderate pace, parallel to work surface.
Excessive fog	Too much, or too fast-drying thinner. Too much atomization air pressure.	Remix properly. Reduce pressure.
Dry Spray	Air pressure too high. Gun tip too far from work surface. Gun motion too fast. Gun out of adjustment	Reduce air pressure. Adjust to proper distance. Slow down. Adjust.
Fluid leaking from packing nut	Packing nut loose. Packing worn or dry	Tighten, do not bind needle. Replace or lubricate.
Fluid leaking or dripping from front of pressure feed gun	Packing nut too tight. Dry packing. Fluid tip or needle worn or damaged. Foreign matter in tip. Fluid needle spring broken. Wrong size needle or tip.	Adjust. Lubricate. Replace tip & needle with lapped sets. Clean. Replace. Replace.
Runs and sags	Too much material flow. Material too thin. Gun tilted on an angle, or gun motion too slow.	Adjust gun or reduce fluid pressure. Mix properly or apply light coats. Hold gun at right angle to work and adapt to proper gun technique
Thin, sandy coarse finish drying before it flows out	Gun too far from surface. Too much air pressure. Improper thinner being used.	Check distance. Normally approx. 8". Reduce air pressure and check spray pattern. Follow paint manufacturer's mixing instructions.

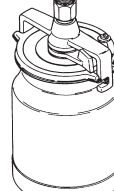
*Most common problem.

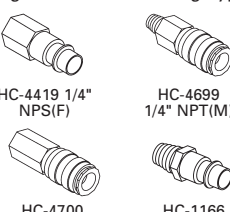
TROUBLESHOOTING (continued)

CONDITION	CAUSE	CORRECTION
Thick, dimpled finish "orange peel".	Gun too close to surface. Too much material coarsely atomized. Air pressure too low. Improper thinner being used. Material not properly mixed. Surface rough, oily, dirty.	Check distance. Normally approx. 8". Increase air pressure or decrease fluid pressure. Increase air pressure or reduce fluid pressure. Follow paint manufacturer's mixing instructions. Follow paint manufacturer's mixing instructions. Properly clean and prepare.

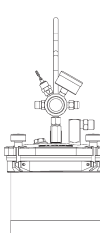
ACCESSORIES

<p>P-H-5516 Air Adjusting Valve</p>  <p>Enables user to control and reduce air usage at the gun. Ideal for low pressure spraying.</p>	<p>HAV-500 or HAV-501 Adjusting Valve (HAV-501 SHOWN)</p>  <p>HAV-500 does not have pressure gage. Use to control air usage at gun.</p>	<p>HD-503 SolventSaver™ Hose/Gun Cleaner</p>  <p>2 Qt Hose/Gun Cleaner used to clean the inside of hose, fluid passageways of gun & other paint equipment.</p>	<p>HARG-510 Air Regulator</p>  <p>Use to maintain nearly constant outlet pressure despite changes in inlet pressure and downstream flow.</p>	<p>29-3100-K6 Scrubs® Hand Cleaner Towels</p>  <p>Scrubs® are a pre-moistened hand cleaner towel for painters. No water is needed.</p>	<p>SPN-5 Wrench</p>  <p>Contains all necessary tip, hose and nut sizes used on or with gun.</p>
<p>42884-214-K5 3/8" 42884-215-K10 5/8" Cleaning Brushes</p>  <p>These brushes are helpful in cleaning threads and recesses of gun body.</p>	<p>PLH-MF-6-100 Mini-Strainer (100 mesh)</p>  <p>For trapping foreign particles in the paint supply.</p>	<p>83GZ-5200 SolventSaver™ Hose/Gun Cleaner</p>  <p>2 Gallon galvanized tank used to clean the inside of hose and material passages of the gun.</p>	<p>SP-402-K Air Adjusting Valve</p>  <p>Installs into gun to enable user to control and reduce air usage at the gun. Replaces SP-637 plug.</p>	<p>Spray Gun Lube SSL-10 (2 oz. bottle)</p>  <p>Compatible with all paint materials: contains no silicone or petroleum distillates to contaminate paint. SDS sheet available upon request.</p>	<p>Siphon Cups TGC-545 Aluminum 80-510 Stainless Steel</p> 
<p>Millennium 3000 Twin Cartridge Paint Spray Respirator</p>  <p>40-141 Small 40-128 Medium 40-143 Large</p> <p>NIOSH-Certified, for respiratory protection in atmospheres not immediately dangerous to life.</p>	<p>Quick Disconnect Approved for HVLP Guns (Air) High Flow Ball and Ring Type</p>  <p>HC-4419 1/4" NPS(F) HC-4699 1/4" NPT(M) HC-4700 1/4" NPT(F) HC-1166 1/4" NPT(M)</p>	<p>KB-555 (Aluminum) & KB-545-SS (S/S) 2 qt. Pressure Feed Cup With Regulator</p>  <p>Provides greater degree of control over cup fluid pressure.</p>	<p>HAF-507-K2 Whirlwind™ In-Line Air Filter</p>  <p>Removes water, oil, and debris from the air line.</p>		
<p>MPV-60-K3 Air Inlet Swivel (Pack of 3)</p>  <p>Fits Compact gun only. Compatible with DeVilbiss high flow quick disconnects.</p>	<p>83C-220 2 Gallon Tank</p>  <p>Zinc plated tank.</p>	<p>80-600 SG2 Plus Cup</p>  <p>2 qt. cup. Waterborne compatible when 80-356 liner is used.</p>	<p>80-295 Cup</p>  <p>2 qt. aluminum cup with regulator.</p>		
<p>Plastic Tipped Fluid Needle</p>  <p>SP-300P-10-K Compatible with SP-200S-08-K (0.55 mm) and SP-200S-10-K (1.0 mm) fluid tips</p> <p>SP-300P-14-K Compatible with SP-200S-14-K fluid tips</p>					

WARRANTY POLICY

This product is covered by Carlisle Fluid Technologies' materials and workmanship limited warranty. The use of any parts or accessories, from a source other than Carlisle Fluid Technologies, will void all warranties. Failure to reasonably follow any maintenance guidance provided may invalidate any warranty.

For specific warranty information please contact Carlisle Fluid Technologies.

For technical assistance or to locate an authorized distributor, contact one of our international sales and customer support locations.

Region	Industrial / Automotive	Automotive Refinishing
Americas	Tel: 1-800-992-4657 Fax: 1-888-246-5732	Tel: 1-800-445-3988 Fax: 1-800-445-6643
Europe, Africa, Middle East, India	Tel: +44 (0)1202 571 111 Fax: +44 (0)1202 573 488	
China	Tel: +8621-3373 0108 Fax: +8621-3373 0308	
Japan	Tel: +81 45 785 6421 Fax: +81 45 785 6517	
Australia	Tel: +61 (0) 2 8525 7555 Fax: +61 (0) 2 8525 7575	

For the latest information about our products, visit www.carlisleleft.com

Carlisle Fluid Technologies is a global leader in innovative finishing technologies. Carlisle Fluid Technologies reserves the right to modify equipment specifications without prior notice.

BGK™, Binks®, DeVilbiss®, Hosco®, MS®, and Ransburg® are all registered trademarks of Carlisle Fluid Technologies, Inc.

©2020 Carlisle Fluid Technologies, Inc.
All rights reserved.

